



# **imageCLASS**

**MF269dw / MF267dw / MF264dw**

# **User's Guide**

# Contents

<b>Setting Up</b> .....	3
<b>Main Functions</b> .....	4
<b>Preparations Required Before Use</b> .....	5
<b>Preventing Unauthorized Access</b> .....	7
<b>Setting Up Using the Setup Guide</b> .....	9
<b>Setting the Date/Time</b> .....	11
<b>Setting Up the Network Environment</b> .....	14
Selecting Wired LAN or Wireless LAN .....	16
Connecting to a Wired LAN .....	17
Connecting to a Wireless LAN .....	18
Setting Up Connection Using WPS Push Button Mode .....	20
Setting Up Connection Using WPS PIN Code Mode .....	22
Setting Up Connection by Selecting a Wireless Router .....	24
Setting Up Connection by Specifying Detailed Settings .....	27
Checking the SSID and Network Key .....	30
Setting IP Addresses .....	31
Setting IPv4 Address .....	32
Setting IPv6 Addresses .....	35
Viewing Network Settings .....	38
Configuring Settings for Communication with a Computer .....	41
Configuring Printing Protocols and WSD Functions .....	42
Configuring Printer Ports .....	45
Setting Up Print Server .....	49
Configuring the Machine for Your Network Environment .....	52
Configuring Ethernet Settings .....	53
Changing the Maximum Transmission Unit .....	55
Setting a Wait Time for Connecting to a Network .....	56
Configuring DNS .....	57
Configuring SMB .....	61
Monitoring and Controlling the Machine with SNMP .....	63
Configuring SNTP .....	67
<b>Installing Drivers</b> .....	69
<b>Configuring Initial Settings for Fax Functions</b> .....	70
Deciding Which Fax Receive Mode to Use .....	71
Registering the Fax Number and Unit Name .....	72
Selecting the Receive Mode .....	73
Connecting the Telephone Line .....	74
<b>Configuring Scan Settings</b> .....	76
Preparing to Use the Machine as a Scanner .....	77
Procedure for Setting to Send E-Mail .....	78
Configuring Basic E-Mail Settings .....	79
Configuring E-Mail Communication Settings .....	82
Procedure for Setting a Shared Folder as a Save Location .....	85

Setting a Shared Folder as a Save Location .....	86
--	----

## **Basic Operations** ..... 91

### **Parts and Their Functions** ..... 94

Front Side .....	95
Back Side .....	97
Interior .....	98
Feeder .....	99
Multi-Purpose Tray .....	100
Drawer .....	101
Operation Panel .....	102

### **Turning ON the Machine** ..... 107

Turning OFF the Machine .....	108
-------------------------------	-----

### **Using the Operation Panel** ..... 109

Basic Screens .....	110
Home Screen .....	111
<Status Monitor> Screen .....	115
Message Display .....	117
Basic Operation .....	118
Entering Text .....	123

### **Placing Originals** ..... 128

### **Loading Paper** ..... 132

Loading Paper in the Drawer .....	134
Loading Paper in the Multi-Purpose Tray .....	138
Loading Envelopes .....	141
Loading Preprinted Paper .....	143
Specifying Paper Size and Type .....	145
Specifying Paper Size and Type in the Drawer .....	146
Specifying Paper Size and Type in the Multi-Purpose Tray .....	147
Registering a Custom Paper Size .....	148
Limiting the Paper Sizes Displayed .....	150

### **Customizing the Display** ..... 151

Customizing the Home Screen .....	152
-----------------------------------	-----

### **Changing the Default Settings for Functions** ..... 154

### **Setting Sounds** ..... 155

### **Entering Quiet Mode** ..... 157

### **Entering Sleep Mode** ..... 159

### **Registering Destinations** ..... 161

Registering Destinations in the Address Book .....	163
Registering Destinations for One-Touch Dial .....	165
Registering Multiple Destinations as a Group .....	167
Editing the Registered Destinations in the Address Book .....	169

## **Copying** ..... 171

### **Basic Copy Operations** ..... 173

Canceling Copies .....	177
Checking the Copying Status and Log .....	179
<b>Enhancing and Adjusting Copy Quality .....</b>	<b>180</b>
Selecting the Type of Original for Copying .....	181
Adjusting Sharpness for Copying (Sharpness) .....	182
<b>Useful Copy Functions .....</b>	<b>184</b>
Copying Multiple Documents onto One Sheet (N on 1) .....	185
Using <Paper Save Copy> .....	187
Collating Copies by Page .....	188
Making ID Card Copies .....	189
Making Passport Copy .....	190
<b>Faxing .....</b>	<b>193</b>
<b>Basic Operations for Sending Faxes .....</b>	<b>195</b>
Canceling Sending Faxes .....	202
<b>Receiving Faxes .....</b>	<b>203</b>
<b>Useful Functions When Sending .....</b>	<b>207</b>
Recalling Previously Used Settings for Sending (Recall Settings) .....	208
Sending a Fax after a Phone Call (Manual Sending) .....	210
<b>Various Receiving Methods .....</b>	<b>212</b>
Saving Received Documents into the Machine (Memory Reception) .....	213
<b>Forwarding the Received Documents Automatically .....</b>	<b>215</b>
<b>Checking Status and Log for Sent and Received Documents .....</b>	<b>217</b>
<b>Sending Faxes from Your Computer (PC Fax) .....</b>	<b>219</b>
Sending PC Faxes .....	220
<b>Printing .....</b>	<b>223</b>
<b>Printing from a Computer .....</b>	<b>224</b>
Canceling Prints .....	226
Checking the Printing Status and Log .....	228
<b>Scanning .....</b>	<b>231</b>
<b>Basic Operations for Scanning Originals .....</b>	<b>233</b>
Scanning and Saving to a Computer .....	234
Scanning Using the Shortcut Key .....	236
Sending Data by E-Mail/Saving Data to a Shared Folder .....	239
Canceling Sending Documents .....	247
Checking Status and Log for Scanned Originals .....	249
<b>Scanning Clearly .....</b>	<b>251</b>
Adjusting Image Quality .....	252
Adjusting Density .....	253
Adjusting Sharpness When Scanning (Sharpness) .....	254
<b>Useful Scanning Functions .....</b>	<b>255</b>
Adjusting Balance between File Size and Image Quality .....	256

Recalling Previously Used Settings for Sending/Saving (Recall Settings) .....	257
Specifying E-Mail Settings .....	259
<b>Using Your Computer to Scan (Remote Scan) .....</b>	<b>261</b>
Scanning Documents from an Application .....	262
Using ScanGear MF .....	264

## **Linking with Mobile Devices .....** 266

<b>Connecting with Mobile Devices .....</b>	<b>267</b>
Connecting via a Wireless LAN Router (LAN Connection) .....	268
Connecting Directly (Access Point Mode) .....	269
<b>Utilizing the Machine through Applications .....</b>	<b>272</b>
<b>Using AirPrint .....</b>	<b>273</b>
Printing with AirPrint .....	278
Scanning with AirPrint .....	281
Faxing with AirPrint .....	283
If AirPrint Cannot Be Used .....	285
<b>Using Google Cloud Print .....</b>	<b>286</b>
<b>Managing the Machine by the Remote Control .....</b>	<b>288</b>

## **Managing the Machine .....** 290

<b>Setting Access Privileges .....</b>	<b>292</b>
Setting the System Manager PIN .....	293
Setting a Remote UI PIN .....	295
<b>Configuring the Network Security Settings .....</b>	<b>297</b>
Restricting Communication by Using Firewalls .....	299
Specifying IP Addresses for Firewall Settings .....	300
Specifying MAC Addresses for Firewall Settings .....	303
Changing Port Numbers .....	305
Setting a Proxy .....	306
Configuring the Key and Certificate for TLS .....	308
Generating the Key and Certificate for Network Communication .....	310
Generating a Key and Certificate Signing Request (CSR) .....	313
Registering the Key and Certificate for Network Communication .....	316
Configuring IEEE 802.1X Authentication Settings .....	318
<b>Restricting the Machine's Functions .....</b>	<b>322</b>
Restricting Access to Address Book and Sending Functions .....	324
Restricting Use of the Address Book .....	325
Limiting Available Destinations .....	327
Restricting the Fax Sending Functions .....	329
Restricting USB Functions .....	331
Disabling HTTP Communication .....	332
Disabling Remote UI .....	333
<b>Managing the Machine from a Computer (Remote UI) .....</b>	<b>334</b>
Starting Remote UI .....	335
Checking the Status and Logs .....	338

Setting Up Menu Options from Remote UI .....	344
<b>Registering Destinations from Remote UI .....</b>	<b>347</b>
<b>Saving/Loading Address Book from Remote UI .....</b>	<b>351</b>
<b>Importing/Exporting Address Book Data with the Supplied Software .....</b>	<b>353</b>
<b>Updating the Firmware .....</b>	<b>355</b>
<b>Initializing Settings .....</b>	<b>358</b>

## **Setting Menu List ..... 361**

<Direct Connection> .....	362
<Network Settings> .....	363
<Output Rprt.>/<Output Reports> .....	374
<Preferences> .....	375
<Timer Settings> .....	381
<Common Settings> .....	385
<Copy Settings> .....	387
<Fax Settings> .....	389
<Scan Settings> .....	400
<Printer Settings> .....	405
<Adjustment/Maintenance> .....	415
<System Management Settings> .....	421

## **Maintenance ..... 430**

<b>Regular Cleaning .....</b>	<b>432</b>
Cleaning the Exterior .....	433
Cleaning the Platen Glass .....	434
Cleaning the Feeder .....	435
Cleaning the Fixing Assembly .....	439
Cleaning the Machine Interior .....	440
<b>Replacing the Toner Cartridge .....</b>	<b>443</b>
<b>Replacing the Drum Cartridge .....</b>	<b>447</b>
<b>Checking the Remaining Amount of Consumables .....</b>	<b>451</b>
<b>Relocating the Machine .....</b>	<b>452</b>
<b>Viewing the Counter Value .....</b>	<b>454</b>
<b>Printing Reports and Lists .....</b>	<b>455</b>
<b>Consumables .....</b>	<b>460</b>

## **Troubleshooting ..... 464**

<b>Common Problems .....</b>	<b>466</b>
Installation/Settings Problems .....	467
Copying/Printing Problems .....	471
Faxing/Telephone Problems .....	474
<b>When You Cannot Print Properly .....</b>	<b>476</b>
Printing Results Are Not Satisfactory .....	478
Paper Creases or Curls .....	487

Paper Is Fed Incorrectly .....	489
<b>A Message or a Number Starting with "#" (an Error Code) Is Displayed .....</b>	<b>490</b>
Countermeasures for Each Message .....	491
Countermeasures for Each Error Code .....	504
<b>Clearing Paper Jams .....</b>	<b>510</b>
Paper Jams in the Feeder .....	511
Paper Jams inside the Machine .....	514
<b>When a Problem Cannot Be Solved .....</b>	<b>518</b>

## **Appendix .....** 521

<b>Third Party Software .....</b>	<b>522</b>
<b>Feature Highlights .....</b>	<b>523</b>
Going Green and Saving Money .....	524
Improving Efficiency .....	526
Going Digital .....	528
So Much More .....	530
<b>Specifications .....</b>	<b>532</b>
Main Unit .....	533
Feeder .....	536
Available Paper .....	538
Fax Function .....	541
Scan Function .....	542
Printer Functions .....	543
Management Functions .....	545
System Environment .....	546
Network Environment .....	548
<b>Manuals and Their Contents .....</b>	<b>549</b>
<b>Using User's Guide .....</b>	<b>550</b>
Screen Layout of User's Guide .....	551
Viewing User's Guide .....	554
<b>Basic Windows Operations .....</b>	<b>556</b>
<b>Menu Route Map .....</b>	<b>564</b>
<b>Notice .....</b>	<b>565</b>

# Setting Up

<b>Setting Up</b> .....	3
<b>Main Functions</b> .....	4
<b>Preparations Required Before Use</b> .....	5
<b>Preventing Unauthorized Access</b> .....	7
<b>Setting Up Using the Setup Guide</b> .....	9
<b>Setting the Date/Time</b> .....	11
<b>Setting Up the Network Environment</b> .....	14
Selecting Wired LAN or Wireless LAN .....	16
Connecting to a Wired LAN .....	17
Connecting to a Wireless LAN .....	18
Setting Up Connection Using WPS Push Button Mode .....	20
Setting Up Connection Using WPS PIN Code Mode .....	22
Setting Up Connection by Selecting a Wireless Router .....	24
Setting Up Connection by Specifying Detailed Settings .....	27
Checking the SSID and Network Key .....	30
Setting IP Addresses .....	31
Setting IPv4 Address .....	32
Setting IPv6 Addresses .....	35
Viewing Network Settings .....	38
Configuring Settings for Communication with a Computer .....	41
Configuring Printing Protocols and WSD Functions .....	42
Configuring Printer Ports .....	45
Setting Up Print Server .....	49
Configuring the Machine for Your Network Environment .....	52
Configuring Ethernet Settings .....	53
Changing the Maximum Transmission Unit .....	55
Setting a Wait Time for Connecting to a Network .....	56
Configuring DNS .....	57
Configuring SMB .....	61
Monitoring and Controlling the Machine with SNMP .....	63
Configuring SNMP .....	67
<b>Installing Drivers</b> .....	69
<b>Configuring Initial Settings for Fax Functions</b> .....	70
Deciding Which Fax Receive Mode to Use .....	71
Registering the Fax Number and Unit Name .....	72
Selecting the Receive Mode .....	73



Connecting the Telephone Line .....	74
<b>Configuring Scan Settings</b> .....	<b>76</b>
Preparing to Use the Machine as a Scanner .....	77
Procedure for Setting to Send E-Mail .....	78
Configuring Basic E-Mail Settings .....	79
Configuring E-Mail Communication Settings .....	82
Procedure for Setting a Shared Folder as a Save Location .....	85
Setting a Shared Folder as a Save Location .....	86

# Setting Up

---

2KUU-000

Before using the functions of the machine, the environmental conditions must be set in advance. To begin with, check the sequences of flow required to complete the setup, and then perform the actual settings. **▶Preparations Required Before Use(P. 5)**

## NOTE

- The functions installed on the machine vary depending on the model you purchased. Before using the machine, see **▶Main Functions(P. 4)** and check the available functions.

### Configuring Initial Settings of the Machine (Setup Guide)

- You can easily configure the initial settings required to use the machine, such as date, time, and network settings, by following the on-screen guidance. **▶Setting Up Using the Setup Guide(P. 9)**

## Main Functions

2KUU-001

This manual covers all the functions of the model series you purchased. Before getting started, check which functions are available on the model you purchased.

✓ : With function    — : Without function

Function	MF269dw	MF267dw	MF264dw
Copy	✓	✓	✓
Print	✓	✓	✓
Fax	✓	✓	—
Scan	✓	✓	✓
2-sided printing	✓	✓	✓
Forward received faxes	✓	✓	—
Send scanned data (e-Mail/SMB)	✓	✓	—
Wired LAN connection	✓	✓	✓
Wireless LAN connection	✓	✓	✓
Linking with Mobile Devices	✓	✓	✓
Display	Touch Panel	Touch Panel	5 Lines LCD
Feeder / Platen glass cover	Feeder (2-sided scanning)	Feeder (1-sided scanning)	Feeder (1-sided scanning)

### NOTE

- For the available driver types, see the CD-ROM/DVD-ROM supplied with the machine, or see the Canon website (<http://www.canon.com/>).
- In the User's Guide, when operations differ depending on screens, distinctions are highlighted with the different descriptions: "Touch Panel Model" and "5 Lines LCD Model".
- When operations are the same for both models, the screens from the touch panel display will be used for explanation in most cases. The 5 Lines LCD Model has screens different from those of the Touch Panel Model. In either case, follow the on-screen terms to perform operations.

### LINKS

▶ **Viewing User's Guide(P. 554)**

## Preparations Required Before Use

2KUU-002

Set up the machine following steps 1 to 5 in order. For more information about a particular step, click on the link to go to the corresponding section. In addition, to use the machine safely, also check [▶ Preventing Unauthorized Access\(P. 7\)](#) .

### Step 1

#### ▶ Setting Up Using the Setup Guide(P. 9)



### Step 2

#### ▶ Setting Up the Network Environment(P. 14)

- Configure the network settings that are not covered in the Setup Guide. If you do not need to use the Setup Guide, configure the network settings from here.



### Step 3

#### ▶ Installing Drivers(P. 69)



### Step 4

#### ▶ Configuring Initial Settings for Fax Functions(P. 70)



### Step 5

#### ▶ Configuring Scan Settings(P. 76)



## TIPS

### Setting from the Remote UI

- When the network environment settings are complete, you can efficiently set the machine from a computer using Remote UI. ▶ **Starting Remote UI(P. 335)**

## Preventing Unauthorized Access

2KUU-003

This section describes the security measures on how to prevent unauthorized access from the external network. This is a must-read for all users and administrators before using this machine, other printers, and multifunction machines connected to the network. In recent years, a printer/multifunction machine connected to the network can offer you a variety of useful functions, such as printing from a computer, operating from a computer using the remote function, and sending scanned documents via the Internet. On the other hand, it is essential to take security measures to reduce the security risk for information leakage, as a printer/multifunction machine has become more exposed to threats, such as unauthorized access and theft, when it is connected to the network. This section explains necessary settings you need to specify to prevent unauthorized access before using a printer/multifunction machine connected to the network.

### Security Measures to Prevent Unauthorized Access from the External Network

- ▶ **Assigning a Private IP Address(P. 7)**
- ▶ **Using Firewall to Restrict Transmission(P. 8)**
- ▶ **Specifying the TLS Encrypted Communication (P. 8)**
- ▶ **Setting PIN to Manage Information Stored in the Machine(P. 8)**

### Assigning a Private IP Address

An IP address is a numerical label assigned to each device participating in a computer network. A "global IP address" is used for the communication connecting to the Internet, and a "private IP address" is used for the communication within a local area network, such as a LAN in the company. If a global IP address is assigned, your printer/multifunction machine is open to the public and can be accessed via the Internet. Thus, the risk of information leakage due to unauthorized access from external network increases. On the other hand, if a private IP address is assigned, your printer/multifunction machine is closed to a local area network and can be accessed by only users on your local area network, such as a LAN in the company.

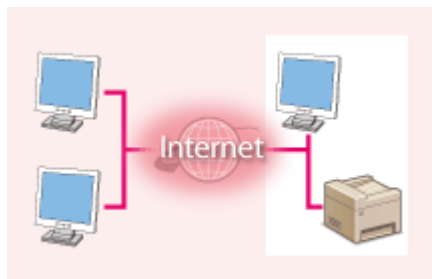

**Global IP Address**

Can be accessed from the external network

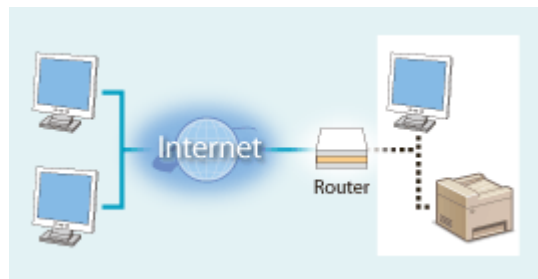

**Private IP Address**

Can be accessed from the users within a local area network

Basically, assign a private IP address to your printer/multifunction machine. Make sure to confirm the IP address, assigned to the printer/multifunction machine you are using, is a private IP address or not. A private IP address is found in one of the following ranges.

#### ■ Ranges for Private IP addresses

- From 10.0.0.0 to 10.255.255.255
- From 172.16.0.0 to 172.31.255.255
- From 192.168.0.0 to 192.168.255.255

For information on how to confirm the IP address, see ▶ **Setting IPv4 Address(P. 32)** .

### NOTE

- If a global IP address is assigned to a printer/multifunction machine, you can create a network environment to reduce the risk of unauthorized access by installing security software, such as a firewall that prevents

access from the external networks. If you want to assign a global IP address to and use a printer/multifunction machine, contact your network administrator.

## Using Firewall to Restrict Transmission

A firewall is a system that prevents unauthorized access from the external networks and protects against attacks/intrusions to a local area network. You can use a firewall on your network environment to block access from the external network that appears to be dangerous, by restricting communication from specified IP address of the external network. The function installed to a Canon printer/multifunction machine enables you to set up the IP address filter. For information on how to set up an IP address filter, see [▶Specifying IP Addresses for Firewall Settings\(P. 300\)](#) .

## Specifying the TLS Encrypted Communication

For information on the TLS Encrypted Communication, see [▶Configuring the Network Security Settings\(P. 297\)](#) , and on the procedures to specify, see [▶Configuring the Key and Certificate for TLS\(P. 308\)](#) .

## Setting PIN to Manage Information Stored in the Machine

If a malicious third party attempts to gain unauthorized access to a printer/multifunction machine, setting PIN to information stored in the machine will reduce the risk of information leakage. Canon printers/multifunction machines enable you to protect various type of information by setting PIN.

### ■Setting PIN to Each Function

- Setting PIN for Using Remote UI  
For more information, see [▶Setting a Remote UI PIN\(P. 295\)](#) .
- Setting PIN for the System Manager Settings  
For more information, see [▶Setting the System Manager PIN\(P. 293\)](#) .
- Address Book PIN  
For more information on setting a PIN, see [▶Restricting Use of the Address Book\(P. 325\)](#) .

Listed above are some examples of security measures for preventing unauthorized access. For more information on the other security measures, see [▶Managing the Machine\(P. 290\)](#) and take necessary security measures for preventing unauthorized access to suit your environment.

# Setting Up Using the Setup Guide

2KUU-004

When the machine is turned on ( **Turning ON the Machine(P. 107)** ) for the first time, the Setup Guide starts up to assist you to configure the initial settings of the machine by following the on-screen guidance. In the Setup Guide, the setting screens are displayed in the following order.

## Step 1

### Setting the Display Language and the Country or Region

Set the language to be displayed on the operation panel screen or in reports, as well as the country or region where the machine will be used.

- 1 Select a language.
- 2 For a touch panel model, select <Yes>.
- 3 Select a country or region.

## Step 2

### Setting the Date and Time

Adjust the machine's date/time.

- 1 Select a time zone.

#### NOTE:

##### What is UTC?

- Coordinated Universal Time (UTC) is the primary time standard by which the world regulates clocks and time. The correct UTC time zone setting is required for Internet communications.

- 2 Enter the date and time, and press <Apply> ( **OK** ).

#### Touch Panel Model

Tap **< >** or **> <** to move the cursor, and enter the date and time using the numeric keys. Tap **< ^ >** or **< v >** to switch between <AM> or <PM>.

#### 5 Lines LCD Model

Use **< >** or **> <** to move the cursor, and enter the date and time using the numeric keys. Use **< ^ >** or **< v >** to switch between <AM> or <PM>.

## Step 3

### Setting the Wireless LAN

Configure the settings to connect to the network using the wireless LAN.

- 1 Select <Yes>.
  - Select <No> to finish the Setup Guide without configuring the wireless LAN settings. Read the displayed message, and press <Close> ( **OK** ).
- 2 Select <OK>.
- 3 Select the setting method.
  - For more information about the wireless LAN settings, see **Connecting to a Wireless LAN(P. 18)** .
- 4 Read the message that is displayed, and press <Close> ( **OK** ).



⇒ When the Setup Guide is complete, the screen below appears.

**Touch Panel Model**

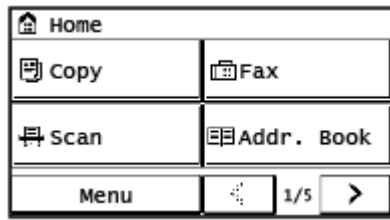

**5 Lines LCD Model**

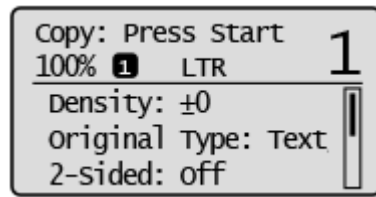

# Setting the Date/Time

Set the date and time for the machine. The date and time are used as the reference for the functions specifying the time, therefore, they need to be set accurately.

- ▶ **Setting the Time Zone(P. 11)**
- ▶ **Setting the Current Date and Time(P. 11)**
- ▶ **Setting the Daylight Saving Time(P. 12)**

## Setting the Time Zone

If the time zone setting is changed, the values set in <Current Date/Time Settings> are also changed accordingly.

### 1 Display the <Menu> screen. ▶ Home Screen(P. 111)

#### Touch Panel Model

Select <Menu> in the Home screen.

#### 5 Lines LCD Model

Press .

### 2 Select <Timer Settings> ▶ <Date/Time Settings> ▶ <Time Zone>.

### 3 Select the time zone.



## NOTE

### What is UTC?

- Coordinated Universal Time (UTC) is the primary time standard by which the world regulates clocks and time. Time differences exist depending on the country or area where the machine is used. The correct UTC time zone setting is required for Internet communications.

## Setting the Current Date and Time

### 1 Display the <Menu> screen. ▶ Home Screen(P. 111)

**Touch Panel Model**

Select <Menu> in the Home screen.

**5 Lines LCD Model**

Press .

**2** Select <Timer Settings> ► <Date/Time Settings> ► <Current Date/Time Settings>.

**3** Enter the date and time.

**Touch Panel Model**

Tap < ◀ > or < ▶ > to move the cursor, and enter the date and time using the numeric keys. Tap < ▲ > or < ▼ > to switch between <AM> or <PM>.

**5 Lines LCD Model**

Use ◀ or ▶ to move the cursor, and enter the date and time using the numeric keys. Use ▲ or ▼ to switch between <AM> or <PM>.

**4** Press <Apply> (  ).

**IMPORTANT**

- Set <Time Zone> before setting the current date and time. If the <Time Zone> setting is changed later, the current date and time are also changed accordingly.

**NOTE**

- The display format of the date and time can be changed, respectively.
  - ◀ <Date Format>(P. 381)
  - ◀ <Time Format>(P. 382)

**Setting the Daylight Saving Time**

If daylight saving time is enabled, specify the dates from which and to which daylight saving time is in effect.

**1** Display the <Menu> screen. ▶ Home Screen(P. 111)

**Touch Panel Model**

Select <Menu> in the Home screen.

**5 Lines LCD Model**

Press .

**2** Select <Timer Settings> ► <Date/Time Settings> ► <Daylight Saving Time Settings>.

**3 Select <Off> or <On> in <Daylight Saving Time>.**

- When you select <On>, proceed to step 4.

**4 Set the month and day for the start date, and then select <Apply>.**

- To set the day, specify "what day of which week."

**5 Set the month and day for the end date, and then select <Apply>.**

- To set the day, specify "what day of which week."

# Setting Up the Network Environment

2KUU-006

When connecting the machine to a wired or wireless local area network (LAN), you need to set an IP address unique to the selected network. Select "wired" or "wireless" depending on your communication environment and networking devices. For specific IP address settings, contact your Internet service provider or Network Administrator.

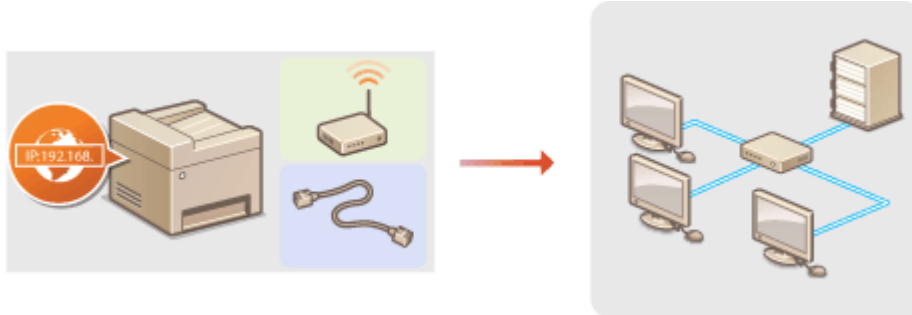

## IMPORTANT

- If the machine is connected to an unsecured network, your personal information might be leaked to a third party.

## NOTE

- The machine cannot connect to both wired and wireless LANs at the same time.
- The machine does not come with a LAN cable or router. Have them ready as necessary.
- For more information about your networking devices, see the instruction manuals for the devices or contact your manufacturer.

### ■ Before You Start

Follow these steps to connect the machine to a network.



#### Check your computer settings.

- Make sure that the computer is correctly connected to the network. For more information, see the instruction manuals for the devices you are using, or contact the device manufacturers.
- Make sure that the network settings have been completed on the computer. If the network has not been set up properly, you will not be able to use the machine on the network, even if you perform the rest of the procedure below.

#### NOTE:

- Depending on the network, you may need to change settings for the communication method or the Ethernet type ( [▶Configuring Ethernet Settings\(P. 53\)](#) ). For more information, contact your Internet service provider or Network Administrator.
- To check the MAC address of the machine.
  - ▶[Viewing the MAC Address for Wired LAN\(P. 38\)](#)
  - ▶[Viewing the MAC Address and Information for Wireless LAN\(P. 39\)](#)

- To connect to an IEEE 802.1X network, see [▶Configuring IEEE 802.1X Authentication Settings\(P. 318\)](#) .



2



**Select wired or wireless LAN.**

- ▶[Selecting Wired LAN or Wireless LAN\(P. 16\)](#)



3



**Connect to a wired or wireless LAN.**

- Proceed to the section that corresponds to the setting you selected in step 2.
  - ▶[Connecting to a Wired LAN\(P. 17\)](#)
  - ▶[Connecting to a Wireless LAN\(P. 18\)](#)



4



**Set the IP address as necessary.**

- At the time of purchase, the machine is set to automatically acquire an IP address. Change this setting if you want to use a specific IP address. ▶[Setting IP Addresses\(P. 31\)](#)

LINKS

---

- ▶[Configuring Settings for Communication with a Computer\(P. 41\)](#)
- ▶[Configuring the Machine for Your Network Environment\(P. 52\)](#)

# Selecting Wired LAN or Wireless LAN

---

2KUU-007

After you decide on wired or wireless LAN to connect the machine to the computer, select wired LAN or wireless LAN using the operation panel. Note that if you change the setting from <Wired LAN> to <Wireless LAN> or vice versa, you will need to uninstall the drivers installed on your computer and then reinstall them. For more information, see the manuals for the relevant drivers on the online manual website.

## 1 Display the <Menu> screen. [▶Home Screen\(P. 111\)](#)

### Touch Panel Model

Select <Menu> in the Home screen.

### 5 Lines LCD Model

Press .

## 2 Select <Network Settings>.

- If the screen for entering a PIN appears, enter the correct PIN. [▶Setting the System Manager PIN\(P. 293\)](#)

## 3 Select <Select Wired/Wireless LAN>.

## 4 Select <Wired LAN> or <Wireless LAN>.

### LINKS

---

- [▶Setting Up the Network Environment\(P. 14\)](#)
- [▶Connecting to a Wired LAN\(P. 17\)](#)
- [▶Connecting to a Wireless LAN\(P. 18\)](#)

## Connecting to a Wired LAN

2KUU-008

Connect the machine to a computer via a router. Use a LAN cable to connect the machine to the router.

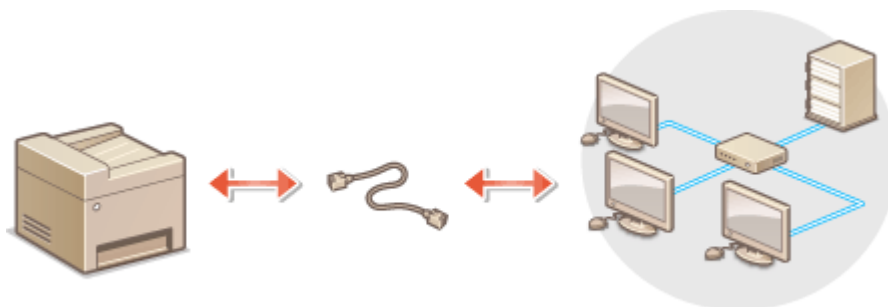

### 1 Connect a LAN cable.

- Connect the machine to a router by using a LAN cable.
- Push the connector in until it clicks into place.

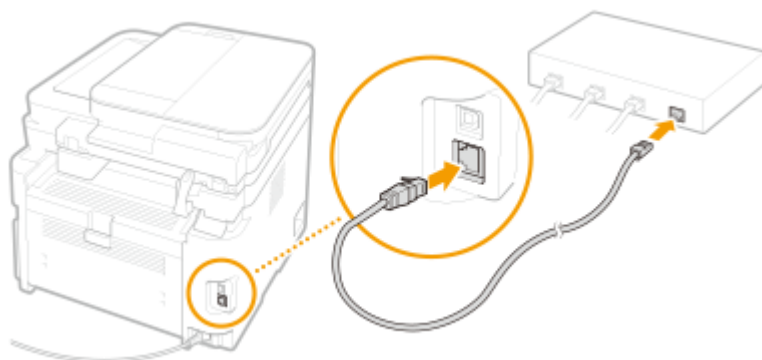

### 2 Wait for several minutes.

⇒ The IP address is set automatically.

#### NOTE:

- You can set the IP address manually. [Setting IP Addresses\(P. 31\)](#)

#### LINKS

[Setting Up the Network Environment\(P. 14\)](#)



## Connecting to a Wireless LAN

2KUU-009

Wireless routers (or access points) connect the machine to a computer via radio waves. If your wireless router is equipped with Wi-Fi Protected Setup (WPS), configuring your network is automatic and easy. If your networking devices do not support automatic configuration, or if you want to specify authentication and encryption settings in detail, you need to manually set up the connection. Make sure that your computer is correctly connected to the network.

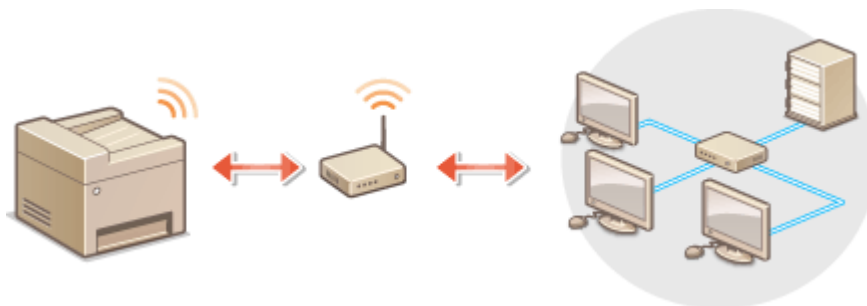

▶ **Setting Up Connection Using WPS(P. 18)**

▶ **Manually Setting Up Connection(P. 19)**

### IMPORTANT

#### Risk of information leak

- Use wireless LAN connection at your own discretion and at your own risk. If the machine is connected to an unsecured network, your personal information might be leaked to a third party because radio waves used in wireless communication can go anywhere nearby, even beyond walls.

#### Wireless LAN security

- The wireless LAN function of this machine supports WEP, WPA-PSK, and WPA2-PSK. For the wireless security compatibility of your wireless router, see the instruction manuals for your networking devices or contact your manufacturer.

### NOTE

#### Required devices for wireless LAN connection

- The machine does not come with a wireless router. Have the router ready as necessary.

### Setting Up Connection Using WPS

When using WPS, two modes are available: push button mode and PIN code mode.

#### ■ Push Button Mode

Find the WPS mark shown below on the package of your wireless router. Also make sure that there is a WPS button on your networking device. ▶ **Setting Up Connection Using WPS Push Button Mode(P. 20)**



## ■ PIN Code Mode

Some WPS routers do not support the push button mode. If WPS PIN code mode is mentioned on the package or in the instruction manuals of your networking device, set up the connection by entering the PIN code. [▶Setting Up Connection Using WPS PIN Code Mode\(P. 22\)](#)

## NOTE

- If the wireless router is set to use WEP authentication, you may not be able to set up connection using WPS.

## Manually Setting Up Connection

When manually setting up a wireless connection, you can either select a wireless router or manually enter the required information. Regardless of the method, make sure that you have the required setup information, including the SSID and network key. [▶Checking the SSID and Network Key\(P. 30\)](#)

### ■ Selecting a Wireless Router

Select this setup option if you need to manually set up the connection but want to complete the setup as easily as possible. [▶Setting Up Connection by Selecting a Wireless Router\(P. 24\)](#)

### ■ Manually Entering the Setup Information

If you want to specify security settings in detail, such as authentication and encryption settings, manually enter the SSID and network key to set up the connection. [▶Setting Up Connection by Specifying Detailed Settings\(P. 27\)](#)

## LINKS

---

[▶Setting Up the Network Environment\(P. 14\)](#)

[▶Selecting Wired LAN or Wireless LAN\(P. 16\)](#)

# Setting Up Connection Using WPS Push Button Mode

2KUU-00A

If your wireless router supports WPS push button mode, you can easily set up a connection with a WPS button.

## IMPORTANT

- How to operate the wireless router may vary on each device. See the instruction manuals for your networking device for help.

### 1 Display the <Menu> screen. Home Screen(P. 111)

#### Touch Panel Model

Select <Menu> in the Home screen.

#### 5 Lines LCD Model

Press .

### 2 Select <Network Settings>.

- If the screen for entering a PIN appears, enter the correct PIN.  Setting the System Manager PIN(P. 293)

### 3 Select <Wireless LAN Settings>.

- If the <Do you want to enable the wireless LAN?>/<Enable the wireless LAN?> message is displayed, select <Yes>.
- If the <Direct Connection will be terminated. Is it OK?> message is displayed, select <Yes>.

### 4 Read the message that is displayed, and select <OK>.

### 5 Select <WPS Push Button Mode>.

### 6 Select <Yes>.

### 7 Press and hold the WPS button on the wireless router.

- The button must be pressed within 2 minutes after selecting <Yes> in step 6.
- Depending on the networking device, you may need to press and hold the button for 2 seconds or longer. See the instruction manuals for your networking device for help.

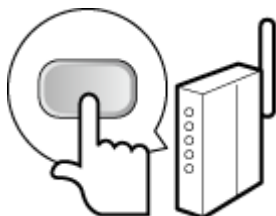
**NOTE:****If an error message is displayed during setup**

- Select <Close> and return to step 5.

**8 Wait until message <Connected.> is displayed.**

⇒ Wait several minutes until the IP address and other items are set automatically.

**IMPORTANT:****Signal strength**

- When more than one wireless router is available for connection, the machine connects to the device with the strongest signal. Signal strength is measured using RSSI (Received Signal Strength Indication).

**NOTE:**

- You can set the IP address manually. ▶ **Setting IP Addresses(P. 31)**
- On the touch panel model, while the machine is connected to the wireless LAN, the Wi-Fi icon is displayed in the Home screen. ▶ **Home Screen(P. 111)**

**NOTE****Reducing power consumption**

- You can set the machine to enter <Power Save Mode> based on signals emitted from the wireless router. ▶ **<Power Save Mode>(P. 364)**

**If the IP address of the machine has changed**

- In a DHCP environment, the IP address of the machine may be changed automatically. If this happens, the connection is maintained as long as the machine and the computer belong to the same subnet.

**LINKS**

- ▶ **Connecting to a Wireless LAN(P. 18)**

# Setting Up Connection Using WPS PIN Code Mode

2KUU-00C

If your wireless router supports WPS PIN code mode, generate a PIN code with the machine and register the code to the networking device.

## IMPORTANT

- How to operate the wireless router may vary on each device. See the instruction manuals for your networking device for help.



### From a Computer

#### 1 Access your wireless router from a computer and display the screen for entering a WPS PIN code.

- For more information, see the instruction manuals for your networking device.



### From the Operation Panel

#### 2 Display the <Menu> screen. ▶ Home Screen(P. 111)

##### Touch Panel Model

Select <Menu> in the Home screen.

##### 5 Lines LCD Model

Press .

#### 3 Select <Network Settings>.

- If the screen for entering a PIN appears, enter the correct PIN. ▶ Setting the System Manager PIN(P. 293)

#### 4 Select <Wireless LAN Settings>.

- If the <Do you want to enable the wireless LAN?>/<Enable the wireless LAN?> message is displayed, select <Yes>.
- If the <Direct Connection will be terminated. Is it OK?> message is displayed, select <Yes>.

#### 5 Read the message that is displayed, and select <OK>.

#### 6 Select <WPS PIN Code Mode>.

#### 7 Select <Yes>.

⇒ The PIN code is generated and shown on the display.



## From a Computer

---

### 8 Register the generated PIN code to the wireless router.

- Register the PIN code on the setup screen displayed in step 1.
- The PIN code must be registered within 10 minutes after selecting <Yes> in step 7.

#### NOTE:

##### If an error message is displayed during setup

- Select <Close> and return to step 6.



## From the Operation Panel

---

### 9 Wait until the message <Connected.> is displayed.

⇒ Wait several minutes until the IP address and other items are set automatically.

#### IMPORTANT:

##### Signal strength

- When more than one wireless router is available for connection, the machine connects to the device with the strongest signal. Signal strength is measured using RSSI (Received Signal Strength Indication).

#### NOTE:

- You can set the IP address manually. ▶ [Setting IP Addresses\(P. 31\)](#)
- On the touch panel model, while the machine is connected to the wireless LAN, the Wi-Fi icon is displayed in the Home screen. ▶ [Home Screen\(P. 111\)](#)

## NOTE

### Reducing power consumption

- You can set the machine to enter <Power Save Mode> based on signals emitted from the wireless router. ▶ [Power Save Mode>\(P. 364\)](#)

### If the IP address of the machine has changed

- In a DHCP environment, the IP address of the machine may be changed automatically. If this happens, the connection is maintained as long as the machine and the computer belong to the same subnet.

## LINKS

---

▶ [Connecting to a Wireless LAN\(P. 18\)](#)

## Setting Up Connection by Selecting a Wireless Router

2KUU-00E

You can search the wireless routers (or access points) available for connection and select one from the display of the machine. For the network key, enter a WEP key or PSK. Before selecting a wireless router, check and write down the required setup information, including the SSID and network key ( [▶Checking the SSID and Network Key\(P. 30\)](#) ).

### NOTE

#### Security settings

- If the wireless connection is set up by selecting a wireless router, the WEP authentication method is set to <Open System> or the WPA/WPA2 encryption method is set to <Auto> (AES-CCMP or TKIP). If you want to select <Shared Key> for WEP authentication or <AES-CCMP> for WPA/WPA2 encryption, you need to set up the connection using <Enter Manually>. [▶Setting Up Connection by Specifying Detailed Settings\(P. 27\)](#)

### 1 Display the <Menu> screen. [▶Home Screen\(P. 111\)](#)

#### Touch Panel Model

Select <Menu> in the Home screen.

#### 5 Lines LCD Model

Press .

### 2 Select <Network Settings>.

- If the screen for entering a PIN appears, enter the correct PIN. [▶Setting the System Manager PIN\(P. 293\)](#)

### 3 Select <Wireless LAN Settings>.

- If the <Do you want to enable the wireless LAN?>/<Enable the wireless LAN?> message is displayed, select <Yes>.
- If the <Direct Connection will be terminated. Is it OK?> message is displayed, select <Yes>.

### 4 Read the message that is displayed, and select <OK>.

### 5 Select <SSID Settings>.

### 6 Select <Select Access Point>.

⇒ The machine starts searching for available wireless routers.

### NOTE:

- If a message is displayed telling that access point cannot be found, see [▶Countermeasures for Each Message\(P. 491\)](#) .

## 7 Select a wireless LAN router.

- Select the router whose SSID matches the one that you have written down.

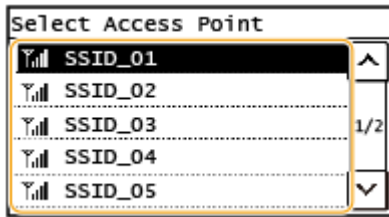

### NOTE:

#### If your wireless router is not found

- Check whether the machine is properly installed and ready to connect to the network. [▶Installation/Settings Problems\(P. 467\)](#)

## 8 Enter the network key that you have written down.

- Enter the network key, and select <Apply>.
- On how to enter text, see [▶Entering Text\(P. 123\)](#) .

## 9 Select <Yes>.

### NOTE:

#### If an error message is displayed during setup

- Select <Close>, check whether the network key is correct, and return to step 5.

## 10 Wait until message <Connected.> is displayed.

⇒ Wait several minutes until the IP address and other items are set automatically.

### IMPORTANT:

#### Signal strength

- When more than one wireless router is available for connection, the machine connects to the device with the strongest signal. Signal strength is measured using RSSI (Received Signal Strength Indication).

### NOTE:

- You can set the IP address manually. [▶Setting IP Addresses\(P. 31\)](#)
- On the touch panel model, while the machine is connected to the wireless LAN, the Wi-Fi icon is displayed in the Home screen. [▶Home Screen\(P. 111\)](#)

## NOTE

### Reducing power consumption

- You can set the machine to enter <Power Save Mode> based on signals emitted from the wireless router. [▶<Power Save Mode>\(P. 364\)](#)



### If the IP address of the machine has changed

- In a DHCP environment, the IP address of the machine may be changed automatically. If this happens, the connection is maintained as long as the machine and the computer belong to the same subnet.

### LINKS

---

▶ **Connecting to a Wireless LAN(P. 18)**

# Setting Up Connection by Specifying Detailed Settings

2KUU-00F

If you want to specify the security settings in detail or cannot establish the wireless connection using the other procedures, manually enter all the required information for the wireless LAN connection. Before specifying detailed settings, check and write down the required information, including the SSID, network key, and wireless security protocols. [▶Checking the SSID and Network Key\(P. 30\)](#)

## 1 Display the <Menu> screen. [▶Home Screen\(P. 111\)](#)

### Touch Panel Model

Select <Menu> in the Home screen.

### 5 Lines LCD Model

Press .

## 2 Select <Network Settings>.

- If the screen for entering a PIN appears, enter the correct PIN. [▶Setting the System Manager PIN\(P. 293\)](#)

## 3 Select <Wireless LAN Settings>.

- If the <Do you want to enable the wireless LAN?>/<Enable the wireless LAN?> message is displayed, select <Yes>.
- If the <Direct Connection will be terminated. Is it OK?> message is displayed, select <Yes>.

## 4 Read the message that is displayed, and select <OK>.

## 5 Select <SSID Settings> ▶ <Enter Manually>.

## 6 Enter the SSID that you have written down.

- Enter the SSID, and select <Apply>.
- On how to enter text, see [▶Entering Text\(P. 123\)](#) .

## 7 Specify the security settings based on the information that you have written down.

- If you do not need to specify the security settings, select <None>.

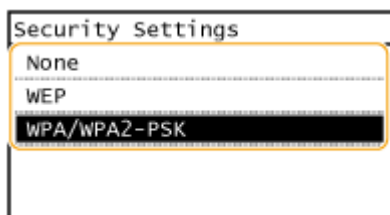

## ■ Using WEP

- 1 Select <WEP>.
- 2 Select an authentication method.

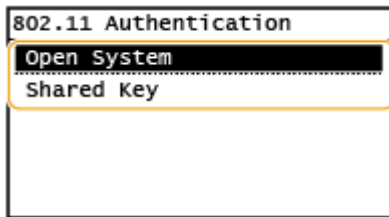

### <Open System>

Sets open system authentication, which is also called "open authentication."

### <Shared Key>

Uses the WEP key as a password.

## NOTE:

### When <Open System> is selected

- When connecting to a wireless LAN, the machine experiences an authentication error if the shared key authentication is set on the wireless router. If this happens, the machine automatically changes the setting to <Shared Key> and retries the connection.

- 3 Select the WEP key you want to edit.
  - Select <Edit WEP Key> ► WEP key (1 to 4).
  - Up to four WEP keys can be registered.
- 4 Enter the network key that you have written down.
  - Enter the network key, and select <Apply>.
- 5 Select the desired WEP key.
  - Select <Select WEP Key> ► select the WEP key you have edited.

## ■ Using WPA-PSK or WPA2-PSK

- 1 Select <WPA/WPA2-PSK>.
- 2 Select an encryption method.

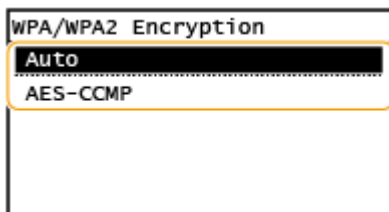

### <Auto>

Sets the machine to automatically select AES-CCMP or TKIP to match the setting of the wireless router.

### <AES-CCMP>

Sets AES-CCMP as the encryption method.

- 3 Enter the network key that you have written down.
  - Enter the network key, and select <Apply>.

## 8 Select <Yes>.

### NOTE:

#### If an error message is displayed during setup

- Select <Close>, check whether the specified settings are correct, and return to step 5.

## 9 Wait until message <Connected.> is displayed.

☞ Wait several minutes until the IP address and other items are set automatically.

### IMPORTANT:

#### Signal strength

- When more than one wireless router is available for connection, the machine connects to the device with the strongest signal. Signal strength is measured using RSSI (Received Signal Strength Indication).

### NOTE:

- You can set the IP address manually. ▶ [Setting IP Addresses\(P. 31\)](#)
- On the touch panel model, while the machine is connected to the wireless LAN, the Wi-Fi icon is displayed in the Home screen. ▶ [Home Screen\(P. 111\)](#)

## NOTE

### Reducing power consumption

- You can set the machine to enter <Power Save Mode> based on signals emitted from the wireless router. ▶ [Power Save Mode>\(P. 364\)](#)

### If the IP address of the machine has changed

- In a DHCP environment, the IP address of the machine may be changed automatically. If this happens, the connection is maintained as long as the machine and the computer belong to the same subnet.

## LINKS

---

- ▶ [Connecting to a Wireless LAN\(P. 18\)](#)

## Checking the SSID and Network Key

2KUU-00H

When manually setting up a wireless connection, you need to specify the SSID and network key of your wireless router. The SSID and network key may be indicated on these networking devices. Check your devices and write down the necessary information before setting up the connection. For more information, see the instruction manuals for your networking devices or contact your manufacturer.

<b>SSID</b>	A name given for identifying a specific wireless LAN. Some other terms used for SSID include "access point name" and "network name."
<b>Network Key</b>	A keyword or password used for encrypting data or authenticating a network. Some other terms used for network key include "encryption key," "WEP key," "WPA/WPA2 passphrase," and "preshared key (PSK)."
<b>Wireless Security Protocols (Authentication/Encryption)</b>	When manually setting up a wireless connection by specifying detailed settings, you need to specify security settings. Check the following information: <ul style="list-style-type: none"> <li>• Security types (WEP/WPA-PSK/WPA2-PSK)</li> <li>• Authentication method (Open System/Shared Key)</li> <li>• Encryption method (TKIP/AES-CCMP)</li> </ul>

### LINKS

- ▶ **Connecting to a Wireless LAN(P. 18)**
- ▶ **Setting Up Connection by Selecting a Wireless Router(P. 24)**
- ▶ **Setting Up Connection by Specifying Detailed Settings(P. 27)**

## Setting IP Addresses

2KUU-00J

Connecting the machine to a network requires a unique network IP address. Two versions of IP addresses are available: IPv4 and IPv6. Configure these settings depending on the network environment. To use IPv6 addresses, you need to properly configure the IPv4 address settings.

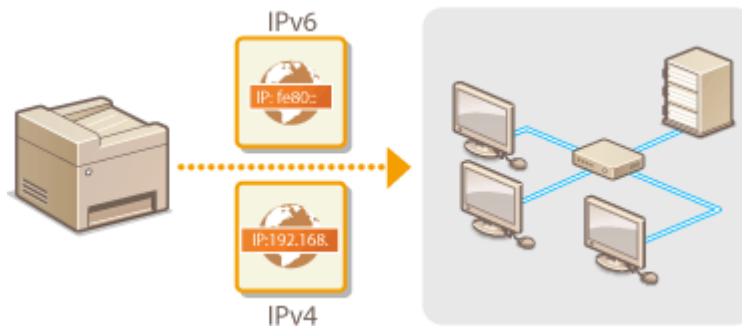

- ▶ [Setting IPv4 Address\(P. 32\)](#)
- ▶ [Setting IPv6 Addresses\(P. 35\)](#)

# Setting IPv4 Address

2KUU-00K



The machine's IPv4 address can be either assigned automatically by a dynamic IP addressing protocol, such as DHCP, or entered manually. When connecting the machine to a wired LAN, make sure that the connectors of the LAN cable are firmly inserted into the ports ( **▶Connecting to a Wired LAN(P. 17)** ). You can test the network connection if necessary.

- ▶Setting IPv4 Address(P. 32)
- ▶Testing the Network Connection(P. 33)

## Setting IPv4 Address

### 1 Display the <Menu> screen. ▶Home Screen(P. 111)

#### Touch Panel Model

Select <Menu> in the Home screen.

#### 5 Lines LCD Model

Press .

### 2 Select <Network Settings>.

- If the screen for entering a PIN appears, enter the correct PIN. ▶Setting the System Manager PIN(P. 293)

### 3 Select <TCP/IP Settings> ▶ <IPv4 Settings> ▶ <IP Address Settings>.

### 4 Configure IP address settings.

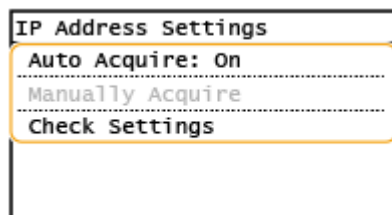

#### <Auto Acquire>

Select to automatically assign an IP address via DHCP protocol. When <On> is displayed, automatic addressing is enabled.

#### <Manually Acquire>

Select to configure the IP address settings by manually entering an IP address. In order to select this option, the automatic acquirement must be set to <Off>.

#### <Check Settings>

Select when you want to view the current IP address settings.

## ■ Automatically assigning an IP address

- 1 Select <Auto Acquire>.
- 2 Select the protocol.
  - Select <Select Protocol> ► <DHCP>.

### NOTE:

#### If you do not want to use DHCP/BOOTP/RARP to assign an IP address

- Select <Off>. If you select <DHCP> when these services are unavailable, the machine will waste time and communication resources searching the network for these services.
- 3 Check that <Auto IP> is set to <On>.
    - If <Off> is selected, change the setting to <On>.
  - 4 Select <Apply>.

### NOTE:

- IP addresses assigned via DHCP override the address obtained via Auto IP.

## ■ Manually entering an IP address

- 1 Configure a setting to disable auto-acquisition.
  - Select <Auto Acquire>, and set both <Select Protocol> and <Auto IP> to <Off>.
- 2 Select <Manually Acquire>.
- 3 Specify the IP address, subnet mask, and gateway address (or default gateway).
  - Enter these values in each screen, and select <Apply>.
  - On how to enter text, see [▶ Entering Text\(P. 123\)](#) .

## NOTE

### Checking whether the settings are correct

- Make sure that the Remote UI screen can be displayed with your computer ( [▶ Starting Remote UI\(P. 335\)](#) ). If a computer is not available, you can check the connection by using the operation panel ( [▶ Testing the Network Connection\(P. 33\)](#) ).

### When you have changed the IP address after installing the printer driver

- When the MFNP port is used, the connection is maintained as long as the machine and the computer belong to the same subnet; therefore, you do not need to add a new port. When the standard TCP/IP port is used, you need to add a new port. [▶ Configuring Printer Ports\(P. 45\)](#)

\*If you do not know which port is used, see [▶ Checking the Printer Port\(P. 561\)](#) .

## Testing the Network Connection

- 1 Display the <Menu> screen. [▶ Home Screen\(P. 111\)](#)



### Touch Panel Model

Select <Menu> in the Home screen.

### 5 Lines LCD Model

Press .

## 2 Select <Network Settings>.

- If the screen for entering a PIN appears, enter the correct PIN. [▶Setting the System Manager PIN\(P. 293\)](#)

## 3 Select <TCP/IP Settings> ▶ <IPv4 Settings> ▶ <PING Command>.

## 4 Enter the IPv4 address of another device on the network, and select <Apply>.

⇒ If a proper connection has been established, <Received response from host.> is displayed.

### LINKS

---

[▶Setting IPv6 Addresses\(P. 35\)](#)

[▶Viewing Network Settings\(P. 38\)](#)

## Setting IPv6 Addresses

2KUU-00L



The IPv6 addresses of the machine can be configured via the Remote UI. Before setting IPv6 addresses, check the IPv4 address settings ( [▶Viewing IPv4 Settings\(P. 38\)](#) ). You need to set the correct IPv4 settings to use IPv6 addresses. Note that the scan function that uses the scanner driver or MF Scan Utility is not available in an IPv6 environment. The machine can use the following multiple IPv6 addresses:

Type	Description
Link-local address	An address that is only valid within a subnet or link and cannot be used to communicate with devices beyond a router. A link-local address is automatically set when the IPv6 function of the machine is enabled.
Manual address	An address that is entered manually. When using this address, specify the prefix length and default router address.
Stateless address	An address that is generated automatically using the MAC address of the machine and the network prefix that is advertised by the router.
Stateful address	An address obtained from a DHCP server using DHCPv6.

### NOTE

- For more information about the basic operations to be performed when setting the machine from the Remote UI, see [▶Setting Up Menu Options from Remote UI\(P. 344\)](#) .

- 1 Start the Remote UI and log in to System Manager Mode. [▶Starting Remote UI\(P. 335\)](#)**
- 2 Click [Settings/Registration] on the Portal page. [▶Remote UI Screen\(P. 336\)](#)**
- 3 Select [Network Settings] ▶ [TCP/IP Settings].**
- 4 Click [Edit] in [IPv6 Settings].**
- 5 Select the [Use IPv6] check box and configure the required settings.**

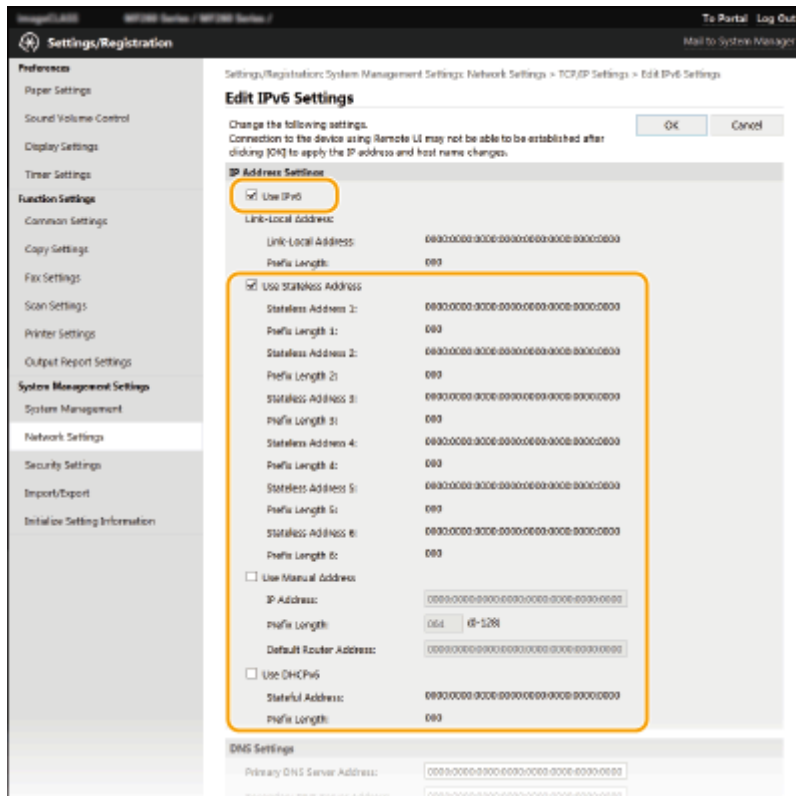
**[Use IPv6]**

Select the check box to enable IPv6 on the machine. When not using IPv6, clear the check box.

**[Use Stateless Address]**

Select the check box when using a stateless address. When not using a stateless address, clear the check box.

**[Use Manual Address]**

When you want to manually enter an IPv6 address, select the check box and enter the IP address, prefix length, and default router address in the corresponding text boxes.

**[IP Address]**

Enter an IPv6 address. Addresses that start with "ff" (or multicast address) and the loopback address (::1) cannot be entered.

**[Prefix Length]**

Enter a number that indicates how many bits are available for the network address.

**[Default Router Address]**

Specify the IPv6 address of the default router as necessary. Addresses that start with "ff" (or multicast address) and the loopback address (::1) cannot be entered.

**[Use DHCPv6]**

Select the check box when using a stateful address. When not using DHCPv6, clear the check box.

**6 Click [OK].****NOTE****Checking whether the settings are correct**

- Make sure that the Remote UI screen can be displayed with your computer by using the IPv6 address of the machine. ▶ **Starting Remote UI (P. 335)**

**Selecting settings from the operation panel**

- IPv6 settings can also be accessed from the <Menu> screen. ▶ **<IPv6 Settings> (P. 367)**

## When you have changed the IP address after installing the printer driver

- You need to add a new port. [▶Configuring Printer Ports\(P. 45\)](#)

### LINKS

---

[▶Setting IPv4 Address\(P. 32\)](#)

[▶Viewing Network Settings\(P. 38\)](#)

# Viewing Network Settings

2KUU-00R

- ▶ Viewing IPv4 Settings(P. 38)
- ▶ Viewing IPv6 Settings(P. 38)
- ▶ Viewing Direct Connection Information(P. 38)
- ▶ Viewing the MAC Address for Wired LAN(P. 38)
- ▶ Viewing the MAC Address and Information for Wireless LAN(P. 39)

## NOTE

- The IP address is not correctly configured if it is displayed as "0.0.0.0".
- Connecting the machine to a switching hub or bridge may result in a connection failure even when the IP address is correctly configured. This problem can be solved by setting a certain interval before the machine starts communicating. ▶ **Setting a Wait Time for Connecting to a Network(P. 56)**
- You can print a list of the current network settings. ▶ **User Data List(P. 457)**

## Viewing IPv4 Settings



 ▶ <Network Information> ▶ <IPv4> ▶ Select the setting to view ▶ Check the settings

## Viewing IPv6 Settings



 ▶ <Network Information> ▶ <IPv6> ▶ Select the setting to view ▶ Check the settings

## Viewing Direct Connection Information



 ▶ <Network Information> ▶ <Direct Connection Information> ▶ <Connection Details> ▶ Check the settings

## Viewing the MAC Address for Wired LAN

- 1 Display the <Menu> screen. ▶ **Home Screen(P. 111)**

### Touch Panel Model

Select <Menu> in the Home screen.

### 5 Lines LCD Model

Press .

## 2 Select <Network Settings>.

- If the screen for entering a PIN appears, enter the correct PIN. [▶Setting the System Manager PIN\(P. 293\)](#)

## 3 Select <Ethernet Driver Settings>.

⇒ MAC address is displayed.

## Viewing the MAC Address and Information for Wireless LAN

## 1 Display the <Menu> screen. [▶Home Screen\(P. 111\)](#)

### Touch Panel Model

Select <Menu> in the Home screen.

### 5 Lines LCD Model

Press .

## 2 Select <Network Settings>.

- If the screen for entering a PIN appears, enter the correct PIN. [▶Setting the System Manager PIN\(P. 293\)](#)

## 3 Select <Wireless LAN Settings>.

- If the <Do you want to enable the wireless LAN?>/<Enable the wireless LAN?> message is displayed, select <Yes>.
- If the <Direct Connection will be terminated. Is it OK?> message is displayed, select <Yes>.

## 4 Read the message that is displayed, and select <OK>.

## 5 Select <Wireless LAN Information>.

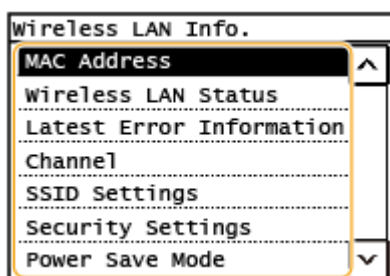

## 6 Select the setting to view.



**NOTE:****Viewing security information**

- To view WEP and WPA/WPA2-PSK information, use the following procedure.  
<Security Settings> ▶ Select the displayed security protocol ▶ Select the setting to view

**Viewing from the <Status Monitor> screen**

- <Wireless LAN Status> and <Latest Error Information> can be viewed from .  
 ▶ <Network Information> ▶ <Network Connection Method> ▶ <Conn. Info>/<Connection Information> ▶ Select the setting to view

**LINKS**

---

- ▶ **Connecting to a Wireless LAN(P. 18)**
- ▶ **Setting IPv4 Address(P. 32)**
- ▶ **Setting IPv6 Addresses(P. 35)**
- ▶ **Configuring DNS(P. 57)**

# Configuring Settings for Communication with a Computer

2KUU-00S

Specify the protocol and port when operating the machine from a computer via the network. Before configuring the machine for printing from a computer, perform the basic setup procedures. For more information, see the manuals for the relevant drivers on the online manual website.



- ▶ [Configuring Printing Protocols and WSD Functions\(P. 42\)](#)
- ▶ [Configuring Printer Ports\(P. 45\)](#)
- ▶ [Setting Up Print Server\(P. 49\)](#)

## NOTE

- Protocols explained here are rules for delivering document data between a computer and the machine, and can be selected according to intended purposes or the network environment.
- Ports are gateways for passing data between network devices. If a communication failure occurs in the network connection, the port settings may be the cause of the problem.



# Configuring Printing Protocols and WSD Functions

2KUU-00U

Configure the protocols that are used for printing documents from a networked computer.

## NOTE

- For more information about the basic operations to be performed when setting the machine from the Remote UI, see [▶Setting Up Menu Options from Remote UI\(P. 344\)](#) .

- 1 Start the Remote UI and log in to System Manager Mode. ▶Starting Remote UI(P. 335)**
- 2 Click [Settings/Registration] on the Portal page. ▶Remote UI Screen(P. 336)**
- 3 Click [Network Settings] ▶ [TCP/IP Settings].**
- 4 Configure printing protocols.**

### ■Configuring LPD or RAW

- 1 Click [Edit] in [LPD Print Settings] or [RAW Print Settings].
- 2 Configure the settings as necessary.

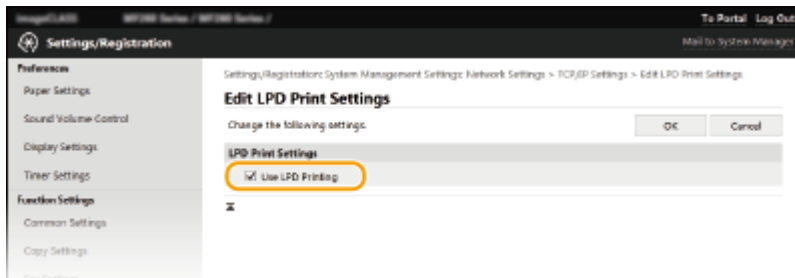

#### [Use LPD Printing]

Select the check box to print via LPD. When not using LPD printing, clear the check box.

#### [Use RAW Printing]

Select the check box to print via RAW. When not using RAW printing, clear the check box.

- 3 Click [OK].

### ■Configuring WSD

- 1 Click [Edit] in [WSD Settings].
- 2 Configure the settings as necessary.

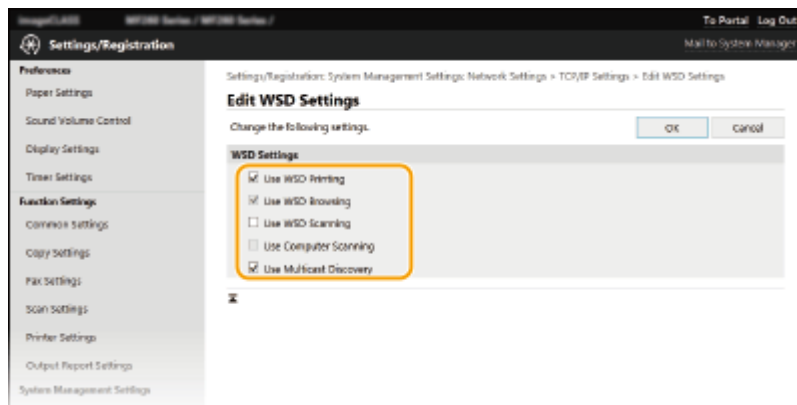

### [Use WSD Printing]

Select the check box to print via WSD. When not using WSD printing, clear the check box.



### [Use WSD Browsing]

Select the check box to obtain information about the machine from a computer via WSD. This check box is automatically selected when the [Use WSD Printing] check box is selected.

### [Use WSD Scanning]

WSD scanning enables you to scan documents to a computer without installing the scanner driver. Select the check box to scan documents via WSD. When not using WSD scanning, clear the check box.

### [Use Computer Scanning]

Select the check box to use WSD scanning by operating the machine with the operation panel. This check box can only be selected when the [Use WSD Scanning] check box is selected. To perform scanning, select <Scan> in the Home screen or press  (COPY/SCAN) key and specify a WSD-connected computer as a scan destination (  **Scanning and Saving to a Computer(P. 234)** ).



### [Use Multicast Discovery]

Select the check box to set the machine to reply to multicast discovery messages. If the check box is cleared, the machine stays in sleep mode even when multicast discovery messages are flowing on the network.



**3** Click [OK].

## NOTE



### Selecting settings from the operation panel

- LPD, RAW, and WSD settings can also be accessed from the <Menu> screen.
  -  <LPD Print Settings>(P. 369)
  -  <RAW Print Settings>(P. 369)
  -  <WSD Settings>(P. 369)

### Setting up WSD network devices

- The WSD network devices can be added from the printer folder. Open the printer folder (  **Displaying the Printer Folder(P. 556)** )  click [Add a device] or [Add a printer] and follow the on-screen instructions. For more information about how to install the driver for the WSD network, see the manuals for the relevant drivers on the online manual website.

### To change the port number

- The same port number used for the machine and a computer must be used for printing protocol.
  -  **Configuring Printer Ports(P. 45)**
  -  **Changing Port Numbers(P. 305)**

LINKS

---

▶ **Configuring Printer Ports(P. 45)**

# Configuring Printer Ports

2KUU-00W

Printing errors can occur when the IP address of the machine has been changed, or when a printer has been added via the Windows printer folder. These errors are typically caused by incorrect printer port settings. For example, an incorrect port number or port type may have been specified. In such situations, your attempt to print fails because the document data cannot reach the machine. To fix this type of problem, configure the printer port settings on the computer.

## IMPORTANT

- To perform the following procedure, log in to your computer with an administrator account.

- 1 Open the printer folder. ▶ **Displaying the Printer Folder(P. 556)**
- 2 Right-click the driver icon for this machine, and click **[Printer properties]** or **[Properties]**.
- 3 Click the **[Ports]** tab and configure the required settings.

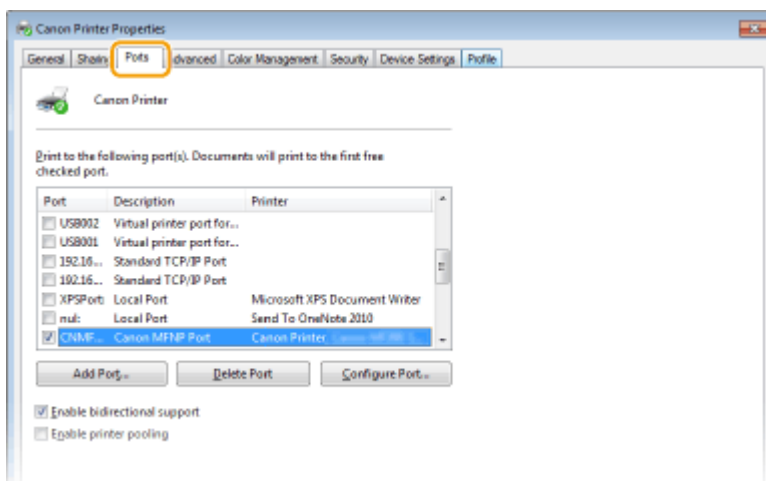

### ■ Adding a port

If you have changed the IP address of the machine or you have selected an incorrect port while installing drivers from the Windows printer folder, add a new port. There are two types of port: "MFNP Port" and "Standard TCP/IP Port." Select the port type according to your environment.

<p>MFNP Port (only for IPv4 environment)</p>	<p>This is a port that allows the IP address of the machine to be detected automatically. Even if the IP address of the machine is changed, the connection is maintained, provided that the machine and the computer are in the same subnet. You do not need to add a new port every time the IP address is changed. If you are using the machine in an IPv4 environment, you should normally select this type of port.</p> <p><b>IMPORTANT:</b></p> <ul style="list-style-type: none"> <li>You can add an MFNP port only when you installed the driver from the provided CD-ROM/DVD-ROM, or when you downloaded and installed the printer driver or the fax driver from the Canon website.</li> </ul>
--	--

Standard TCP/IP Port	This is a standard Windows port. When you use this type of port, you need to add a new port every time that the IP address of the machine is changed. Select this type of port when you are using the machine in an IPv6 environment and when you cannot add an MFNP port.
----------------------	--

Adding an MFNP port

- 1 Click [Add Port].
- 2 Select [Canon MFNP Port] in [Available port types] and click [New Port].
- 3 Select [Auto Detect] and select the machine when it is detected, and then click [Next].



**NOTE:**

**If the machine is not detected**

- Click [Refresh]. If the problem persists, select [IP address] or [MAC address], enter the IP address or MAC address of the machine ( [Viewing Network Settings\(P. 38\)](#) ) and then click [Next].

- 4 Click [Add] ► [Finish].
- 5 Click [Close].

Adding a standard TCP/IP port

- 1 Click [Add Port].
- 2 Select [Standard TCP/IP Port] in [Available port types] and click [New Port].
- 3 Click [Next].
- 4 Enter the IP address or the DNS name of the machine, and click [Next].
  - The [Port Name] is entered automatically. If necessary, you can change it.

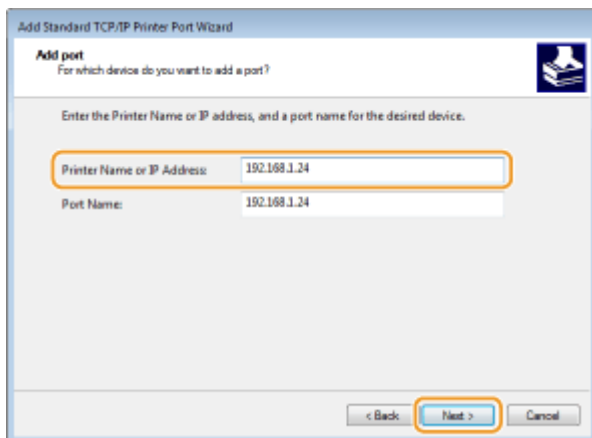

## NOTE:

- When the next screen is displayed, follow the instructions on the screen.

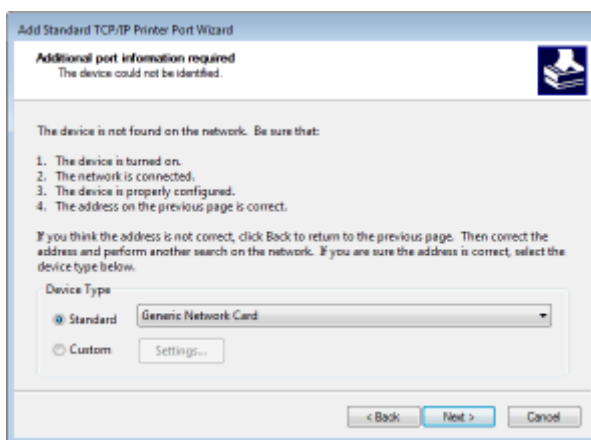

\*When you select the [Device Type], select [Canon Network Printing Device with P9100] under [Standard].

- 5 Click [Finish].
- 6 Click [Close].

## ■ Changing the port type or number

If the printing protocol (LPD or RAW) has been changed on the machine side ( [▶Configuring Printing Protocols and WSD Functions\(P. 42\)](#) ) or the port number has been changed ( [▶Changing Port Numbers\(P. 305\)](#) ), the corresponding settings on the computer must also be configured. This operation is not needed for WSD ports.

### MFNP port

- 1 Click [Configure Port].
- 2 Under [Protocol Type], select [RAW] or [LPR], and change the [Port Number].
- 3 Click [OK].

### Standard TCP/IP port

- 1 Click [Configure Port].
- 2 Under [Protocol], select [Raw] or [LPR].

- If you selected [Raw], change the [Port Number].
- If you selected [LPR], enter "lp" in [Queue Name].

**3** Click [OK].

**4** Click [Close].

## LINKS

---

🔗 [Setting Up Print Server\(P. 49\)](#)

# Setting Up Print Server

2KUU-00X

With a print server, you can reduce the load on the computer that you print from. The print server also makes it possible to install the drivers on each computer over the network, which saves you the trouble of installing the drivers on each computer by using the provided CD-ROM/DVD-ROM. To set up a computer on the network as a print server, configure the settings for sharing the printer.

## IMPORTANT

- To perform the following procedure, log in to your computer with an administrator account.
- You may be unable to install drivers over the network depending on the operating system and the bit architecture (32-bit or 64-bit) of the print server and client computers.
- When implementing a print server in a domain environment, consult your Network Administrator.

**1** Open the printer folder. ▶ **Displaying the Printer Folder(P. 556)**

**2** Right-click the printer driver icon for this machine and click **[Printer properties]** or **[Properties]**.

**3** Click the **[Sharing]** tab, select **[Share this printer]**, and enter the share name of the machine.

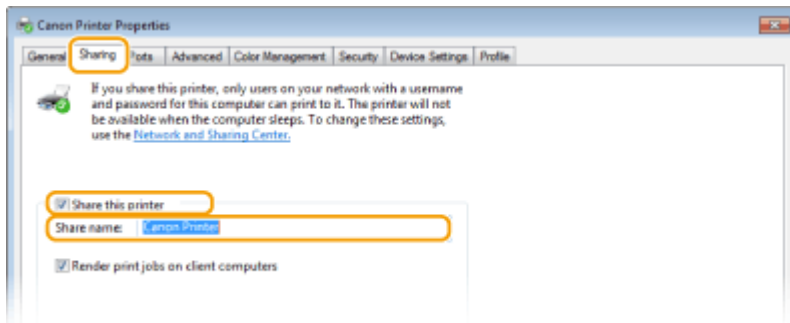

### NOTE:

- Click the **[Change Sharing Options]** button if displayed.

**4** Install additional drivers as necessary.

- This operation is required if you want to install the drivers in other computers running a different bit architecture via the print server.

**1** Click **[Additional Drivers]**.

**2** Select the check box for the bit architecture that other computers are running, and click **[OK]**.



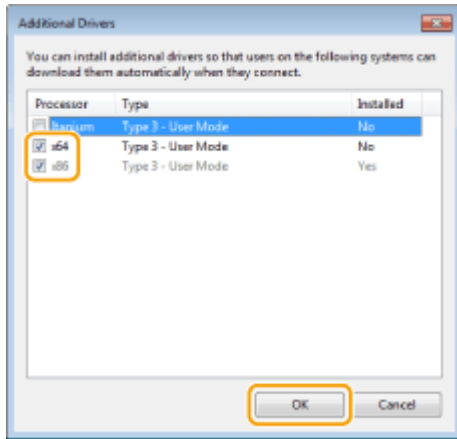

- Select additional drivers from the following, according to the operating system of the print server.

Print server	Select the check box for
32-bit operating systems	[x64]
64-bit operating systems	[x86] under [Processor]

**NOTE:**

- If you do not know whether your Windows operating system is a 32-bit or 64-bit version, see [▶ Checking the Bit Architecture\(P. 559\)](#) .

- 3 Insert the provided CD-ROM/DVD-ROM into the drive on the computer, click [Browse] to specify the folder that contains the drivers, and then click [OK].
  - If the print server runs a 32-bit operating system, select [intdrv] ▶ [UFRII] ▶ [x64] ▶ [Driver] folders on the provided CD-ROM/DVD-ROM.
  - If the print server runs a 64-bit operating system, select [intdrv] ▶ [UFRII] ▶ [32bit] ▶ [Driver] folders on the provided CD-ROM/DVD-ROM.
- 4 Follow the on-screen instructions to install additional drivers.

**5** Click [OK].

■ Installing the Drivers on a Computer via the Print Server

- 1 Locate the shared printer in the print server. [▶ Displaying Shared Printers in the Print Server\(P. 557\)](#)
- 2 Double-click the shared printer.
- 3 Follow the on-screen instructions to install the drivers.

▶ **Printing from a Computer(P. 224)**

## Configuring the Machine for Your Network Environment

2KUU-00Y

The configuration of a network varies depending on the purpose of the network. The machine has been designed to be compatible with as many network configurations as possible, and it is equipped with a variety of technologies. Consult your Network Administrator and set a configuration to suit your network environment.

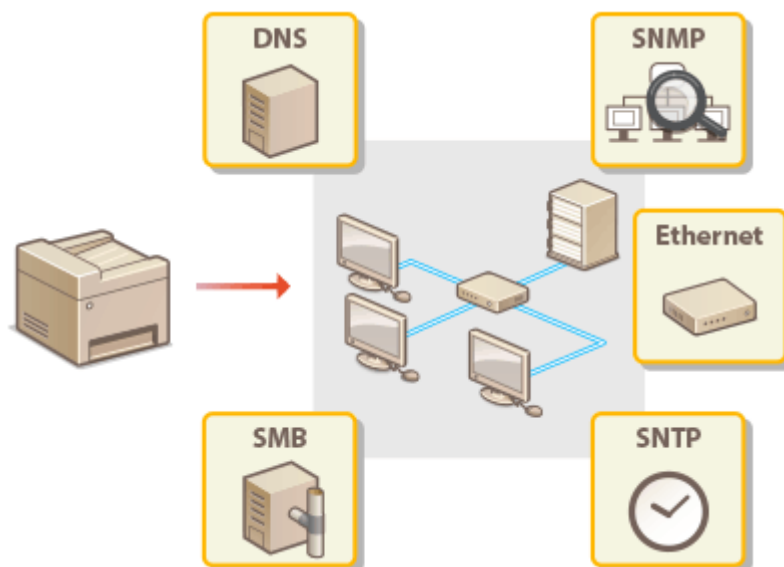

- ▶ [Configuring Ethernet Settings\(P. 53\)](#)
- ▶ [Changing the Maximum Transmission Unit\(P. 55\)](#)
- ▶ [Setting a Wait Time for Connecting to a Network\(P. 56\)](#)
- ▶ [Configuring DNS\(P. 57\)](#)
- ▶ [Configuring SMB\(P. 61\)](#)
- ▶ [Monitoring and Controlling the Machine with SNMP\(P. 63\)](#)
- ▶ [Configuring SNTP\(P. 67\)](#)

# Configuring Ethernet Settings

2KUU-010

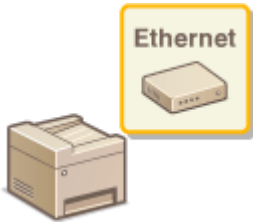

Ethernet is a standard for communicating data in a local area network (LAN). You can set the communication mode and the Ethernet type. In general, the machine can be used without changing the defaults ( ▶<Ethernet Driver Settings>(P. 372) ), but you can change these settings to suit your network environment.

## 1 Display the <Menu> screen. ▶Home Screen(P. 111)

### Touch Panel Model

Select <Menu> in the Home screen.

### 5 Lines LCD Model

Press .

## 2 Select <Network Settings>.

- If the screen for entering a PIN appears, enter the correct PIN. ▶<Setting the System Manager PIN(P. 293)>

## 3 Select <Ethernet Driver Settings> ▶ <Auto Detect>.

## 4 Select whether to configure Ethernet settings automatically or manually.

- If auto-detection is enabled, the machine detects and automatically sets the Ethernet communication mode and the type that can be used.

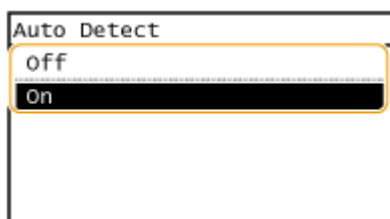

### ■ Configuring Ethernet settings automatically

Select <On> in <Auto Detect>.

### ■ Configuring Ethernet settings manually

- 1 Configure a setting to disable Auto Detect.  
Select <Off> in <Auto Detect>.
- 2 <Communication Mode> ▶ select the communication mode.

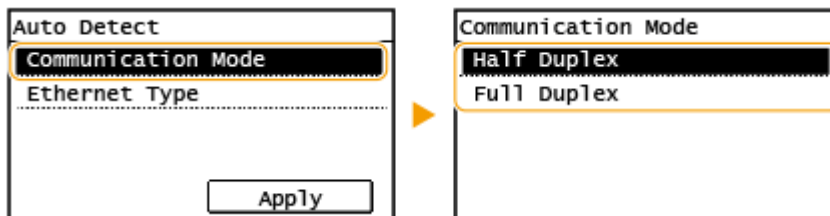
**<Half Duplex>**

Alternately sends and receives communication data. Select when the machine is connected to a networking device using half duplex.

**<Full Duplex>**

Simultaneously sends and receives communication data. Use this setting for most environments.

**3** <Ethernet Type> ► select the Ethernet type.

**4** Select <Apply>.

**LINKS**

---

► **Changing the Maximum Transmission Unit(P. 55)**

► **Setting a Wait Time for Connecting to a Network(P. 56)**

# Changing the Maximum Transmission Unit

---

2KUU-011

In most Ethernet networks, the maximum size of a packet that can be sent is 1500 bytes. A packet refers to a chunk of data into which the original data is divided before being sent. The maximum transmission unit (MTU) may vary on each network. Change the settings of the machine as necessary. For more information, contact your Network Administrator.

## 1 Display the <Menu> screen. [▶ Home Screen\(P. 111\)](#)

### Touch Panel Model

Select <Menu> in the Home screen.

### 5 Lines LCD Model

Press .

## 2 Select <Network Settings>.

- If the screen for entering a PIN appears, enter the correct PIN. [▶ Setting the System Manager PIN\(P. 293\)](#)

## 3 Select <TCP/IP Settings> ▶ <MTU Size>.

## 4 Select the MTU.

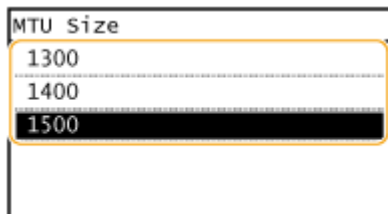

## LINKS

---

[▶ Configuring Ethernet Settings\(P. 53\)](#)

[▶ Setting a Wait Time for Connecting to a Network\(P. 56\)](#)

# Setting a Wait Time for Connecting to a Network

---

2KUU-012

When a network is designed to enjoy redundant connectivity with multiple switching hubs or bridges, it must have a mechanism to prevent packets from looping. One effective solution is to define the role of each switch port. However, communication may still be disrupted for several tens of seconds immediately after you change the way that network devices are connected, or if you add a new device. If this type of problem occurs, set a wait time for connecting to the network.

## 1 Display the <Menu> screen. [▶Home Screen\(P. 111\)](#)

### Touch Panel Model

Select <Menu> in the Home screen.

### 5 Lines LCD Model

Press .

## 2 Select <Network Settings>.

- If the screen for entering a PIN appears, enter the correct PIN. [▶Setting the System Manager PIN\(P. 293\)](#)

## 3 Select <Waiting Time for Connection at Startup>.

## 4 Enter the waiting time required to start a communication with the network, and press <Apply> ().

### LINKS

---

[▶Configuring Ethernet Settings\(P. 53\)](#)

[▶Changing the Maximum Transmission Unit\(P. 55\)](#)

# Configuring DNS

2KUU-013

DNS (Domain Name System) provides a service for name resolution that associates a host (or domain) name with an IP address. Configure the DNS, mDNS, or DHCP option settings as necessary. Note that the procedures for configuring DNS are different for IPv4 and IPv6.



## NOTE

- For more information about the basic operations to be performed when setting the machine from the Remote UI, see [Setting Up Menu Options from Remote UI\(P. 344\)](#).

- 1 Start the Remote UI and log in to System Manager Mode. [Starting Remote UI\(P. 335\)](#)
- 2 Click [Settings/Registration] on the Portal page. [Remote UI Screen\(P. 336\)](#)
- 3 Click [Network Settings] ▶ [TCP/IP Settings].
- 4 Configure DNS settings.

### ■ Configuring IPv4 DNS

- 1 Click [Edit] in [IPv4 Settings].
- 2 Configure IPv4 DNS settings.

The screenshot shows the Network Settings interface with the following sections highlighted:

- a DNS Settings:**
  - Subnet Mask: 255.255.255.0
  - Gateway Address: 192.168.1.1
  - Primary DNS Server Address: 192.168.1.28
  - Secondary DNS Server Address: 192.168.3.10
  - Host Name: CanonHe857
  - Domain Name: [Empty]
  - DNS Dynamic Update
  - DNS Dynamic Update Interval: 24 hr (0-48)
- b mDNS Settings:**
  - If you change the [mDNS Name], the [Printer Name] in [AirPrint Settings] will also be changed.
  - Use mDNS
  - mDNS Name: Canon He857
- c DHCP Options Settings:**
  - Acquire Host Name
  - DNS Dynamic Update
  - Acquire DHCP Server Address
  - Acquire POP Server Address

**a** [DNS Settings]



**[Primary DNS Server Address]**

Enter the IP address of a DNS server.

**[Secondary DNS Server Address]**

Enter the IP address of a secondary DNS server, if any.

**[Host Name]**

Enter alphanumeric characters for the host name of the machine that is to be registered to the DNS server.

**[Domain Name]**

Enter alphanumeric characters for the name of the domain the machine belongs to, such as "example.com."

**[DNS Dynamic Update]**

Select the check box to dynamically update the DNS records whenever the machine's IP address is changed. When specifying the interval between updates, enter the time in hours in the [DNS Dynamic Update Interval] text box.

**b [mDNS Settings]**

**[Use mDNS]**

Adopted by Bonjour, mDNS (multicast DNS) is a protocol for associating a host name with an IP address without using DNS. Select the check box to enable mDNS and enter the mDNS name in the [mDNS Name] text box.

**c [DHCP Option Settings]**

**[Acquire Host Name]**

Select the check box to enable Option 12 to obtain the host name from the DHCP server.

**[DNS Dynamic Update]**

Select the check box to enable Option 81 to dynamically update the DNS records through the DHCP server.

**[Acquire SMTP Server Address ]**

Select the check box to enable Option 69 to obtain an SMTP server address from the DHCP server.

**[Acquire POP Server Address]**

Select the check box to enable Option 70 to obtain a POP3 server address from the DHCP server.

**3** Click [OK].

**■ Configuring IPv6 DNS**

**1** Click [Edit] in [IPv6 Settings].

**2** Configure IPv6 DNS settings.

- The [Use IPv6] check box must be selected to configure the settings. **➤ Setting IPv6 Addresses(P. 35)**

The screenshot shows a network configuration window. At the top, there are fields for 'Default Router Address', 'Use DHCPv6', 'Stateful Address', and 'Prefix Length'. Below this is the 'DNS Settings' section, which is highlighted with a yellow box and labeled 'a'. It contains fields for 'Primary DNS Server Address', 'Secondary DNS Server Address', a checked checkbox for 'Use Same Host Name/Domain Name as IPv4', and fields for 'Host Name' (containing 'CanonFE832') and 'Domain Name'. There are also checkboxes for 'DNS Dynamic Update', 'Register Manual Address', 'Register Stateful Address', and 'Register Stateless Address', along with a 'DNS Dynamic Update Interval' field. Below the DNS settings is the 'mDNS Settings' section, highlighted with a yellow box and labeled 'b'. It contains a checked checkbox for 'Use mDNS', a checked checkbox for 'Use Same mDNS Name as IPv4', and an 'mDNS Name' field containing 'Canon MF100'.

### a [DNS Settings]

#### [Primary DNS Server Address]

Enter the IP address of a DNS server. Addresses that start with "ff" (or multicast address) cannot be entered.

#### [Secondary DNS Server Address]

Enter the IP address of a secondary DNS server, if any. Addresses that start with "ff" (or multicast address) cannot be entered.

#### [Use Same Host Name/Domain Name as IPv4]

Select the check box to use the same host and domain names as in IPv4.

#### [Host Name]

Enter alphanumeric characters for the host name of the machine that is to be registered to the DNS server.

#### [Domain Name]

Enter alphanumeric characters for the name of the domain the machine belongs to, such as "example.com."

#### [DNS Dynamic Update]

Select the check box to dynamically update the DNS records whenever the machine's IP address is changed. To specify the type(s) of addresses you want to register to the DNS server, select the check box for [Register Manual Address], [Register Stateful Address], or [Register Stateless Address]. To specify the interval between updates, enter the time in hours in the [DNS Dynamic Update Interval] text box.

### b [mDNS Settings]

#### [Use mDNS]

Adopted by Bonjour, mDNS (multicast DNS) is a protocol for associating a host name with an IP address without using DNS. Select the check box to enable mDNS.

#### [Use Same mDNS Name as IPv4]

Select the check box to use the same mDNS name as in IPv4. To set a different name, clear the check box and enter the mDNS name in the [mDNS Name] text box.

3 Click [OK].

## NOTE

### Selecting settings from the operation panel

- DNS settings can also be accessed from the <Menu> screen.
  - ▶ <IPv4 Settings>(P. 366)
  - ▶ <IPv6 Settings>(P. 367)

## LINKS

---

- ▶ **Setting IPv4 Address(P. 32)**
- ▶ **Setting IPv6 Addresses(P. 35)**
- ▶ **Viewing Network Settings(P. 38)**

# Configuring SMB

2KUU-014

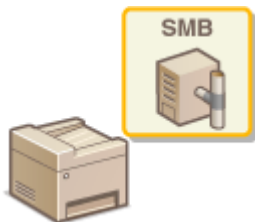

Server Message Block (SMB) is a protocol for sharing resources, such as files and printers, with more than one device in a network. The machine uses SMB to store scanned documents into a shared folder. Depending on your network, you may have to set the NetBIOS name and workgroup name.

## NetBIOS Name

In a Windows network that uses NetBIOS, NetBIOS names are used for identifying network-connected computers as well as for file sharing and other network services. Most computers use the computer name as the NetBIOS name.

## Workgroup Name

Workgroup name is a name for grouping multiple computers so that basic network functions, such as file sharing, become available in a Windows network. Specify the workgroup name to identify the group that the machine belongs to.

## NOTE

- For more information about the basic operations to be performed when setting the machine from the Remote UI, see [▶Setting Up Menu Options from Remote UI\(P. 344\)](#) .

- 1 Start the Remote UI and log in to System Manager Mode. ▶Starting Remote UI(P. 335)**
- 2 Click [Settings/Registration] on the Portal page. ▶Remote UI Screen(P. 336)**
- 3 Select [Network Settings] ▶ [SMB Settings].**
- 4 Click [Edit].**
- 5 Specify the required settings.**

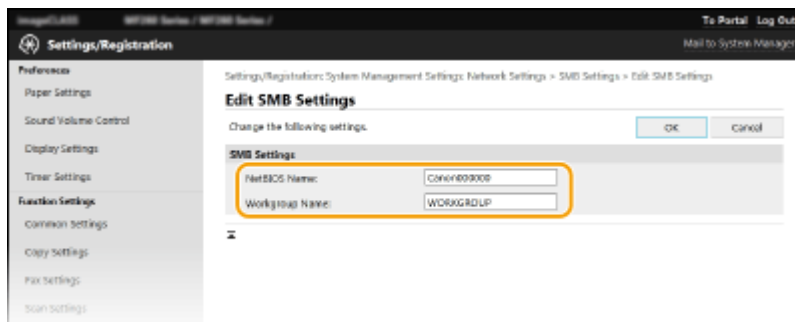

[NetBIOS Name]

Enter alphanumeric characters for the NetBIOS name of the machine.

**[Workgroup Name]**

Enter alphanumeric characters for the name of the workgroup that the machine belongs to.

**6** Click [OK].

## Monitoring and Controlling the Machine with SNMP

2KUU-015

Simple Network Management Protocol (SNMP) is a protocol for monitoring and controlling communication devices in a network by using Management Information Base (MIB). The machine supports SNMPv1 and security-enhanced SNMPv3. You can check the status of the machine from a computer when you print documents or use the Remote UI. You can enable either SNMPv1 or SNMPv3, or both at the same time. Specify the settings for each version to suit your network environment and the purpose of use.

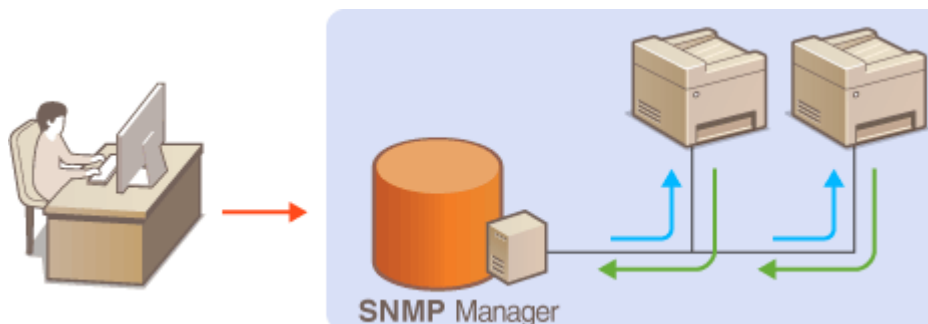

### SNMPv1

SNMPv1 uses information called "community" to define the scope of SNMP communication. Because this information is exposed to the network in plain text, your network will be vulnerable to attacks. If you want to ensure network security, disable SNMPv1 and use SNMPv3.

### SNMPv3

With SNMPv3, you can implement network device management that is protected by robust security features. Note that TLS must be enabled for the Remote UI before configuring SNMPv3 ( [▶Configuring the Key and Certificate for TLS\(P. 308\)](#) ).

## NOTE

- The machine does not support the trap notification feature of SNMP.
- To change the port number of SNMP, see [▶Changing Port Numbers\(P. 305\)](#) .
- SNMP management software, when installed on a computer on the network, enables you to configure, monitor, and control the machine remotely from the computer. For more information, see the instruction manuals for your management software.
- For more information about the basic operations to be performed when setting the machine from the Remote UI, see [▶Setting Up Menu Options from Remote UI\(P. 344\)](#) .

- 1 Start the Remote UI and log in to System Manager mode. [▶Starting Remote UI\(P. 335\)](#)**
- 2 Click [Settings/Registration] on the Portal page. [▶Remote UI Screen\(P. 336\)](#)**
- 3 Select [Network Settings] ▶ [SNMP Settings].**
- 4 Click [Edit].**

## 5 Specify SNMPv1 settings.

- If you do not need to change SNMPv1 settings, proceed to the next step.

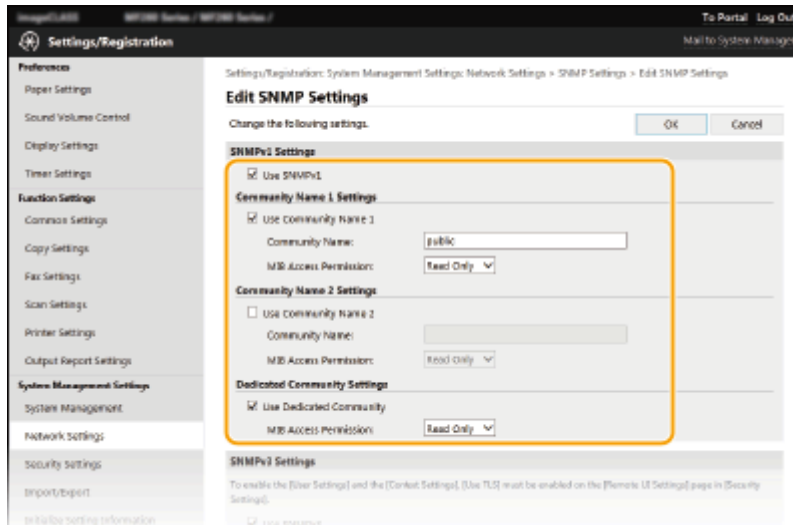

### [Use SNMPv1]

Select the check box to enable SNMPv1. You can specify the rest of SNMPv1 settings only when this check box is selected.

### [Use Community Name 1]/[Use Community Name 2]

Select the check box to specify a community name. If you do not need to specify a community name, clear the check box.

### [Community Name]

Enter alphanumeric characters for the name of the community.

### [MIB Access Permission]

For each community, select [Read/Write] or [Read Only] for the access privileges to MIB objects.

[Read/Write]	Permits both viewing and changing the values of MIB objects.
[Read Only]	Permits only viewing the values of MIB objects.

### [Use Dedicated Community]

Dedicated Community is a preset community, intended exclusively for Administrators using Canon software. Select the check box to use Dedicated Community, and specify [MIB Access Permission]. If you do not need to use Dedicated Community, clear the check box.

## 6 Specify SNMPv3 settings.

- If you do not need to change SNMPv3 settings, proceed to the next step.

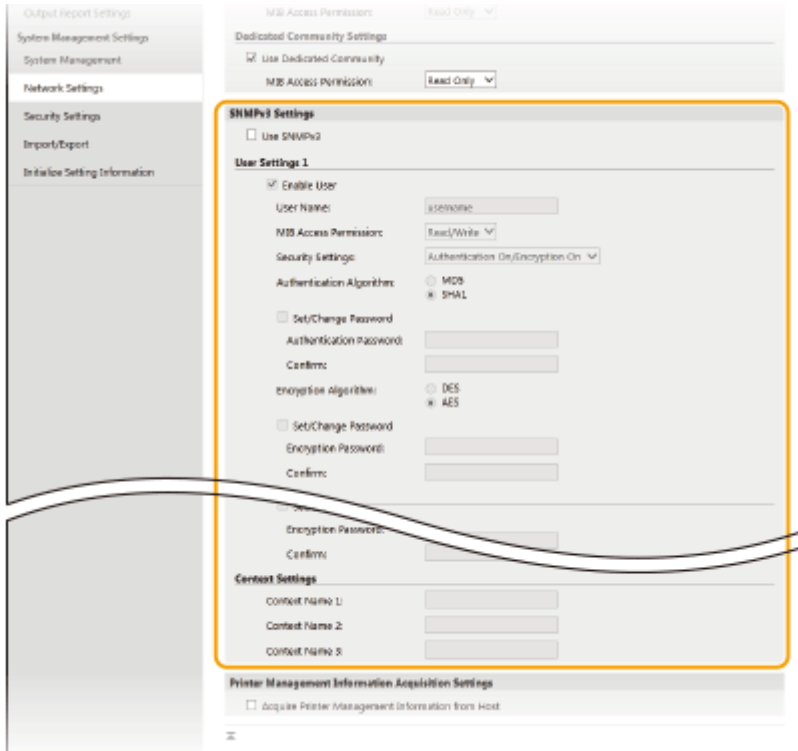

**[Use SNMPv3]**

Select the check box to enable SNMPv3. You can specify the rest of SNMPv3 settings only when this check box is selected.

**[Enable User]**

Select the check box to enable [User Settings 1]/[User Settings 2]/[User Settings 3]. To disable user settings, clear the corresponding check box.

**[User Name]**

Enter alphanumeric characters for the user name.

**[MIB Access Permission]**

Select [Read/Write] or [Read Only] for the access privileges to MIB objects.

[Read/Write]	Permits both viewing and changing the values of MIB objects.
[Read Only]	Permits only viewing the values of MIB objects.

**[Security Settings]**

Select [Authentication On/Encryption On], [Authentication On/Encryption Off], or [Authentication Off/Encryption Off] for the desired combination of authentication and encryption settings.

**[Authentication Algorithm]**

Click the [Authentication On/Encryption On] or [Authentication On/Encryption Off] for [Security Settings] for the algorithm that corresponds to your environment.

**[Encryption Algorithm]**

Click the [Authentication On/Encryption On] for [Security Settings] for the algorithm that corresponds to your environment.

**[Set/Change Password]**

To set or change the password, select the check box and enter alphanumeric characters for the password in the [Authentication Password] or [Encryption Password] text box. For confirmation, enter the same password in the [Confirm] text box. Passwords can be set independently for authentication and encryption algorithms.

**[Context Name 1]/[Context Name 2]/[Context Name 3]**

Enter alphanumeric characters for the context name. Up to three context names can be registered.

**7 Specify Printer Management Information Acquisition Settings.**



- With SNMP, the printer management information, such as printing protocols and printer ports, can be monitored and obtained regularly from a computer on the network.

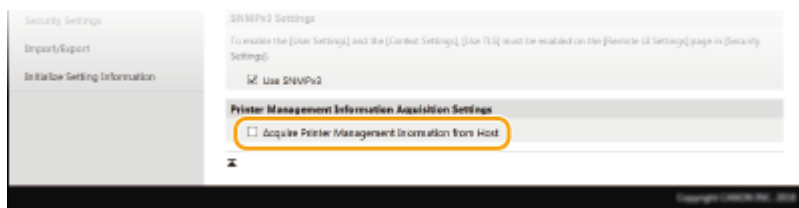

#### [Acquire Printer Management Information from Host]

Select the check box to enable monitoring of the printer management information of the machine via SNMP. To disable monitoring of the printer management information, clear the check box.

## 8 Click [OK].

## NOTE

### Disabling SNMPv1

- If SNMPv1 is disabled, some of the functions of the machine become unavailable, such as obtaining machine information via the printer driver.

### Using the operation panel

- You can also specify SNMPv1 settings and enable/disable SNMPv3 settings from the <Menu> screen. ▶  
<SNMP Settings>(P. 370)

### Enabling Both SNMPv1 and SNMPv3

- If both versions of SNMP are enabled, it is recommended that MIB access permission in SNMPv1 be set to [Read Only]. MIB access permission can be set independently in SNMPv1 and SNMPv3 (and for each user in SNMPv3). Selecting [Read/Write] (full access permission) in SNMPv1 negates the robust security features that characterize SNMPv3 because most of the machine settings can then be controlled with SNMPv1.

## LINKS

- ▶ **Configuring the Key and Certificate for TLS(P. 308)**

# Configuring SNTP

2KUU-016

Simple Network Time Protocol (SNTP) enables you to adjust the system clock by using the time server on the network. If SNTP is used, the time server is checked at the specified intervals; therefore, the correct time can always be maintained. The time is adjusted based on Coordinated Universal Time (UTC), so specify the time zone setting before configuring SNTP ( [▶Setting the Date/Time\(P. 11\)](#) ). SNTP settings can be specified via the Remote UI.

## NOTE

- The SNTP of the machine supports both NTP (version 3) and SNTP (versions 3 and 4) servers.
- For more information about the basic operations to be performed when setting the machine from the Remote UI, see [▶Setting Up Menu Options from Remote UI\(P. 344\)](#) .

- 1 Start the Remote UI and log in to System Manager Mode. [▶Starting Remote UI\(P. 335\)](#)**
- 2 Click [Settings/Registration] on the Portal page. [▶Remote UI Screen\(P. 336\)](#)**
- 3 Select [Network Settings] ▶ [TCP/IP Settings].**
- 4 Click [Edit] in [SNTP Settings].**
- 5 Select the [Use SNTP] check box and specify the required settings.**

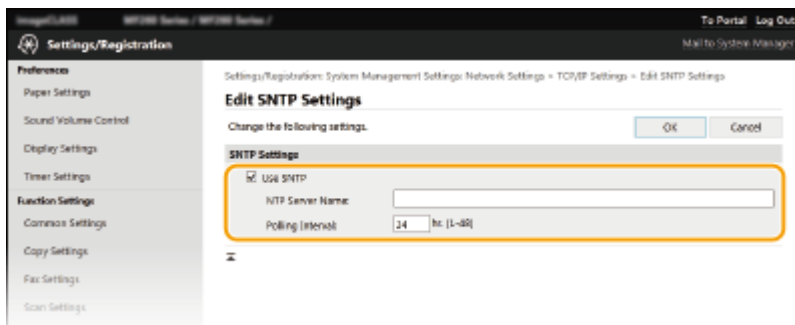

### [Use SNTP]

Select the check box to use SNTP for synchronization. If you do not want to use SNTP, clear the check box.

### [NTP Server Name]

Enter the IP address of the NTP or the SNTP server. If DNS is available on the network, you can enter a host name (or FQDN) consisting of alphanumeric characters instead (example: ntp.example.com).

### [Polling Interval]

Specify the interval between one synchronization and the next.

- 6 Click [OK].**

## NOTE

### Testing communication with the NTP/SNTP server

- You can view communication status with the registered server by clicking [Settings/Registration] ► [Network Settings] ► [TCP/IP Settings] ► [Check NTP Server] in [SNTP Settings]. If a proper connection has been established, the result is displayed as shown below. Note that this operation does not adjust the system clock.

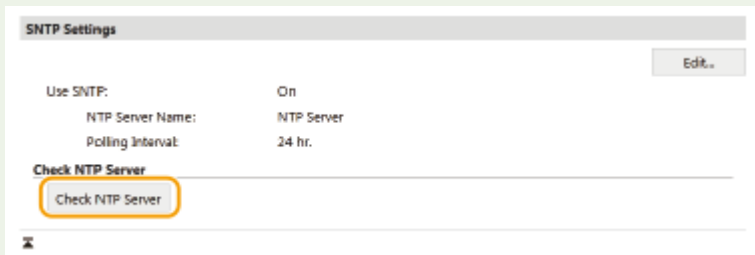

# Installing Drivers

---

2KUU-017

Install the various drivers and associated software on your computer.

## 1 Make the necessary preparation before proceeding with the installation.

- If the machine is supplied with a CD-ROM/DVD-ROM, insert the CD-ROM/DVD-ROM into the drive on the computer.
- You can download drivers and software you are going to use from the Canon website (<http://www.canon.com/>).

### NOTE:

- When new versions of drivers and software become available, they will be uploaded to the Canon website. You can download them as necessary after checking their system requirements.
- Depending on your machine or environmental conditions, some functions may not be available.
- Some of the drivers are not supported depending on the OS. For more information about the supported status of the latest OS, see the Canon website.

## 2 Proceed with the installation.

- For more information about the installation procedure, see the manuals for the drivers and software you are going to use.

## IMPORTANT

- Installation of drivers is impossible if receiving of the IP address are not permitted in [IP Address Filter]. For more information, see [Specifying IP Addresses for Firewall Settings\(P. 300\)](#) .
- If sending and receiving of the IP address of the computer on which drivers are installed become disabled by [IP Address Filter], it is no longer possible to perform printing or send faxes from that computer.

# Configuring Initial Settings for Fax Functions

2KUU-018



Follow steps 1 to 4 described below to configure the fax settings. First, determine which receive mode best suits your intended use, and then follow the on-screen instructions to configure the settings. For more information about a particular step, click on the link to go to the corresponding section.

**Step 1****▶ Deciding Which Fax Receive Mode to Use(P. 71)****Step 2****▶ Registering the Fax Number and Unit Name(P. 72)****Step 3****▶ Selecting the Receive Mode(P. 73)****Step 4****▶ Connecting the Telephone Line(P. 74)**

## Deciding Which Fax Receive Mode to Use

2KUU-019

Before configuring the fax settings, determine which receive mode best suits your intended use.

Intended use	Receive mode	
Use fax only/Never use telephone 	<b>&lt;Auto&gt;</b> This setting is for when you want to use the machine exclusively for receiving faxes, and you do not want to use the telephone.	
Mostly use telephone/Almost never use fax 	<b>&lt;Manual&gt;</b> Connect your telephone to the machine. This setting is for when you mostly want to use the telephone. You can receive incoming faxes manually.	
Use both fax and telephone 	Use answering machine	<b>&lt;Answering Machine&gt;</b> Connect your answering machine. Callers can record a message if they call while you are away from the telephone. The machine automatically receives incoming faxes.
	Use standard telephone	<b>&lt;Fax/Tel (Auto Switch)&gt;</b> Connect your telephone. The machine automatically receives incoming faxes, and the telephone rings for incoming calls.

### NOTE

- Depending on the type of telephone connected to it, the machine may not be able to send or receive faxes properly.
- If you have subscribed to a Distinctive Ring Pattern Detection (DRPD) service provided by your telephone company, <DRPD: Select Fax> is also available for the receiving mode.  
 ▶ **Receiving Faxes(P. 203)**

» Continue to ▶ **Registering the Fax Number and Unit Name(P. 72)**

### LINKS

▶ **Receiving Faxes(P. 203)**

## Registering the Fax Number and Unit Name

2KUU-01A

Register the fax number and unit name of your machine. This information is printed at the top of each page sent from the machine.

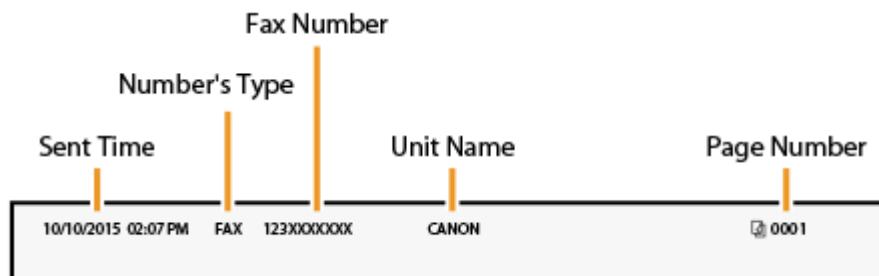

- 1** Select <Menu> in the Home screen. [▶Home Screen\(P. 111\)](#)
  - 2** Select <Fax Settings> ▶ <Fax Setup Guide>.
  - 3** Select <Set Up Now>.
  - 4** Select <Next>.
  - 5** Enter the fax number, and select <Apply>.
  - 6** Select <Next>.
  - 7** Enter the unit name (such as a user name or company name), and select <Apply>.
    - On how to enter text, see [▶Entering Text\(P. 123\)](#) .
    - ⇒ When the unit name has been registered, the RX mode setting screen is displayed.
- » Continue to [▶Selecting the Receive Mode\(P. 73\)](#)

### LINKS

[▶Receiving Faxes\(P. 203\)](#)

## Selecting the Receive Mode

---

2KUU-01C

Select the receive mode that suits your intended use beforehand ( [▶Deciding Which Fax Receive Mode to Use\(P. 71\)](#) ).

### 1 Select <Next>.

### 2 Select the receive mode.

- Select <Yes> or <No> to select the receive mode for the operations you intend to carry out.

#### NOTE:

- If you have subscribed to a Distinctive Ring Pattern Detection (DRPD) service provided by your telephone company, <DRPD: Select Fax> is also available for the receiving mode. [▶Receiving Faxes\(P. 203\)](#)

#### ■ To set the receive mode to <Auto>

Select <No>.

#### ■ To set the receive mode to <Answering Machine>

Select <Yes> ▶ <Yes>.

#### ■ To set the receive mode to <Fax/Tel (Auto Switch)>

Select <Yes> ▶ <No> ▶ <Yes>.

#### ■ To set the receive mode to <Manual>

Select <Yes> ▶ <No> ▶ <No>.

### 3 Select <Apply>.

⇒ When the RX mode has been set, the telephone line connection method is displayed.

### » Continue to [▶Connecting the Telephone Line\(P. 74\)](#)

#### LINKS

---

[▶Receiving Faxes\(P. 203\)](#)



# Connecting the Telephone Line

2KUU-01E

Connect the telephone line to the machine.

## 1 Select <Next>.

- One of the screens shown here is displayed after the receive mode has been set. **Selecting the Receive Mode(P. 73)**

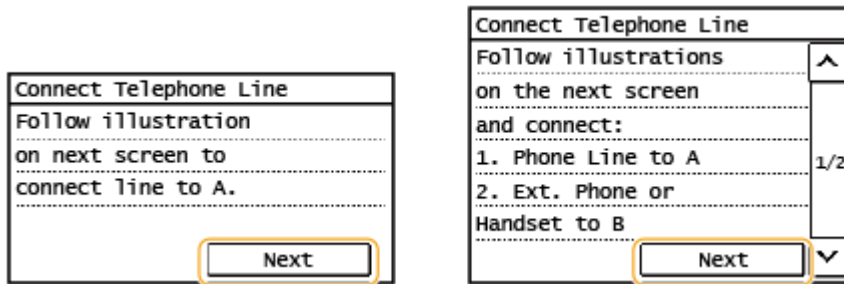

## 2 Connect the telephone line to the machine.

- Connect the included telephone cable to the telephone line jack on the machine (A) and the telephone line jack on the wall.
- If you are using a telephone or answering machine, connect it to the external telephone jack (B).

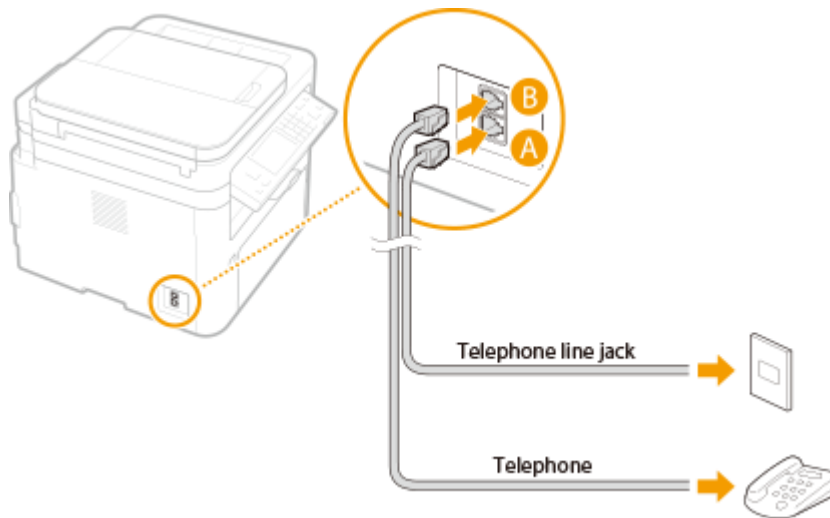

### NOTE:

- If you are connecting an external telephone with fax functions, set up the telephone to receive faxes manually.

## 3 Select <Next> after the telephone line has been connected.

## 4 Select <Yes>.

### If the machine does not automatically set the type of telephone line

---

Follow the procedure below to set the type of telephone line. If you are not sure of the type of phone line you are using, contact your local telephone company.



<Menu> ▶ <Fax Settings> ▶ <Basic Settings> ▶ <Select Line Type> ▶ Select the type of telephone line ▶ 

#### LINKS

---

- ▶ **Basic Operations for Sending Faxes(P. 195)**
- ▶ **Receiving Faxes(P. 203)**

## Configuring Scan Settings

---

2KUU-01F

To send scanned originals directly by e-mail or save them to shared folders, you need to configure the network. The Send Function Setting Tool, an application that is included with the machine, will assist you with the required setup. Set the necessary configuration depending on your purpose and network environment.

### Saving to a Computer

---

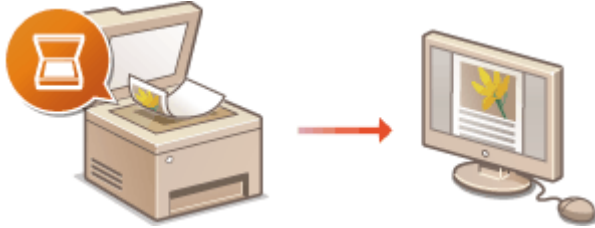

▶ [Preparing to Use the Machine as a Scanner\(P. 77\)](#)

### Scanning to E-mail

---



▶ [Procedure for Setting to Send E-Mail\(P. 78\)](#)

### Scanning to Shared Folders

---

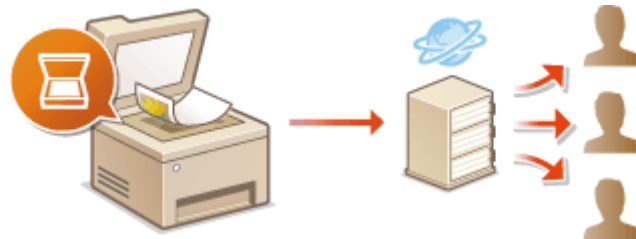

▶ [Procedure for Setting a Shared Folder as a Save Location\(P. 85\)](#)

### LINKS

---

- ▶ [System Environment\(P. 546\)](#)
- ▶ [Scan Function\(P. 542\)](#)

## Preparing to Use the Machine as a Scanner

2KUU-01H

To use this machine as a scanner, you must complete preparations in advance, including installation of software to a computer. For more information, see the manuals for the relevant drivers on the online manual website. In Windows, when connecting this machine to a computer via a wireless or wired LAN, you need to register this machine in "MF Network Scanner Selector" using the following procedure. This procedure is not required if the machine and your computer are connected via USB.

### IMPORTANT

- The scan function is not available if the machine and your computer are connected in an IPv6 environment. Use IPv4 or a USB connection.

**1** Click  in the system tray.

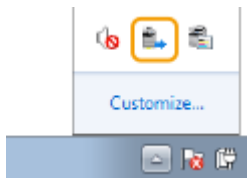

**2** Select the check box for the machine, and click [OK].

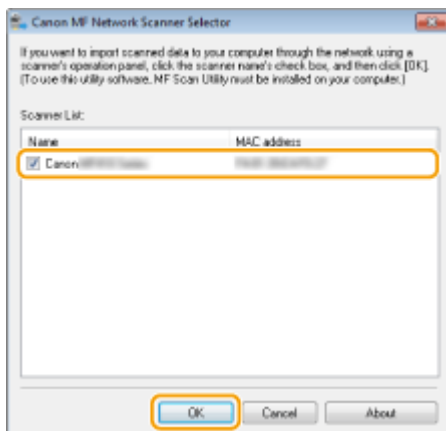

# Procedure for Setting to Send E-Mail

Before configuring the machine for scanning to e-mail, check the setup flow shown below.

1



**Make sure that the machine and the computer are correctly connected.**

- ▶ **Connecting to a Wireless LAN(P. 18)**
- ▶ **Connecting to a Wired LAN(P. 17)**



2



**Make sure that you have the following information:**

- The IP address of the machine. ▶ **Viewing Network Settings(P. 38)**
- An e-mail address to be registered as a destination.
- Information about the e-mail server, including the SMTP server name, port numbers, whether authentication is required, and the user name and password for authentication.

### NOTE:

- For more information about the e-mail server settings, contact your Internet service provider or Network Administrator.



3



**Make sure that the computer meets the system requirements for the Send Function Setting Tool (sending e-mail).**

- System requirements for the Send Function Setting Tool ▶ **System Environment(P. 546)**

### NOTE:

- Also make sure that <Use HTTP> and <Use Remote UI> are set to <On>.
  - ▶ **Disabling HTTP Communication(P. 332)**
  - ▶ **Disabling Remote UI(P. 333)**



4



**Set the machine configuration.**

- Configuring Basic E-Mail Settings ▶ **Configuring Basic E-Mail Settings(P. 79)**
- Configuring Detailed E-Mail Communication Settings (Authentication, Encryption, etc.) ▶ **Configuring E-Mail Communication Settings(P. 82)**

# Configuring Basic E-Mail Settings

2KUU-01K

This section describes how to configure the e-mail settings by using the Send Function Setting Tool. With the Send Function Setting Tool, you can also register e-mail addresses to the Address Book.

## NOTE

- The Send Function Setting Tool helps you configure the basic settings for sending e-mails. Instead of the Send Function Setting Tool, you can use the Remote UI to configure more detailed settings such as the settings for POP authentication before sending or for encrypted communication. [▶Configuring E-Mail Communication Settings\(P. 82\)](#)

## 1 Start the Send Function Setting Tool.

### ■ Using a Web browser

Enter "http://<the IP address of the machine>/sendsupport\_login.html" in the address field of a Web browser, and press the [ENTER] key.

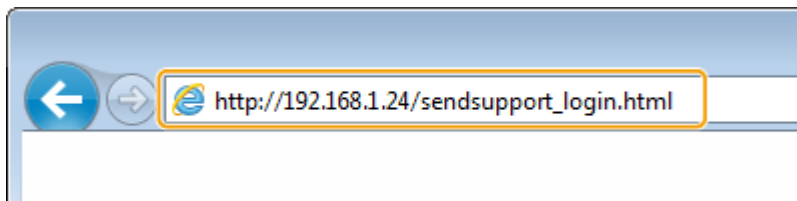

### ■ Using the CD-ROM/DVD-ROM

- 1 Insert the provided CD-ROM/DVD-ROM into the drive on the computer.
  - Select a language and click [OK] if you are prompted to do so.
- 2 Click [Start Software Programs].

#### NOTE:

- If the [Software Programs/Manuals Setup] screen is not displayed, see [▶Displaying the \[Software Programs/Manuals Setup\] Screen\(P. 558\)](#) .
- If [AutoPlay] is displayed, click [Run MInst.exe].

- 3 Click [Start] for [Send Function Setting Tool].
- 4 Click [Next].
  - If you want to view "Send Setting Guide," click [How to Set].

#### NOTE:

- If the screen that cancels the Windows firewall is displayed, click [Yes].

- 5 Select the machine from [Device List] and click [Next].

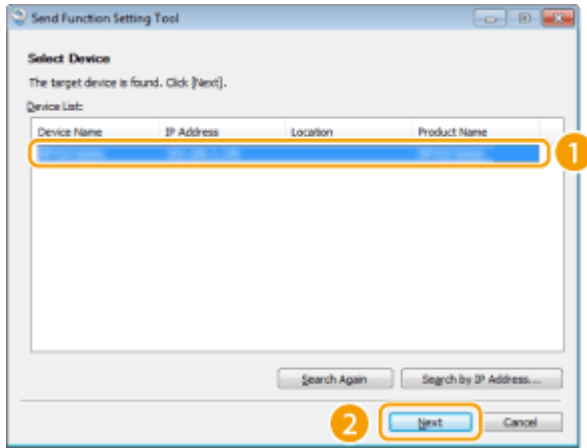

**NOTE:**

**If the machine is not displayed in [Device List]**

- Click [Search Again]. If the problem persists, click [Search by IP Address], enter the IP address of the machine, and then click [OK].

**6** Confirm the settings and click [OK].

**2 Click [Start].**

- If the login screen is displayed, enter the appropriate PIN in the corresponding text boxes, and then click [Logon].

**3 Click [Send to E-mail Settings].**

- If the screen prompting you to enter the Address Book PIN is displayed, enter the PIN for the Address Book, and click [OK]. ▶ **Restricting Use of the Address Book(P. 325)**

**4 Specify the required settings.**

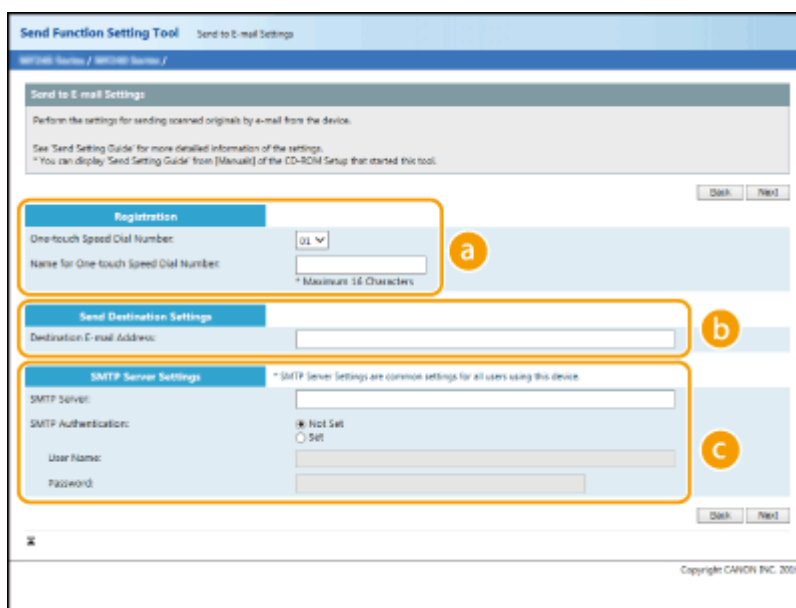

**a [Registration]**

**[One-touch Speed Dial Number]**

With the Send Function Setting Tool, you can register an e-mail address into <One-Touch> in the Address Book. Select a number from the drop-down list.

**[Name for One-touch Speed Dial Number]**

Enter the name for identifying the destination to be registered. Set a name that will be easy for you to find later in the Address Book.

**b [Send Destination Settings]**

**[Destination E-mail Address]**

Enter the e-mail address that you want to send your scanned originals to.

**c [SMTP Server Settings]**

**[SMTP Server]**

Enter the SMTP server name.

**[SMTP Authentication]**

Click the [Not Set] or [Set] radio button to match the authentication settings of the SMTP server. When [Set] is selected, enter the user name in the [User Name] text box and password in the [Password] text box.

**NOTE:**

**Authentication methods for sending e-mails**

- To prevent e-mail transmissions by unauthorized users, the machine supports SMTP authentication (SMTP AUTH) and POP before SMTP. For more information about the required authentication method, contact your Internet service provider or Network Administrator.
- POP before SMTP authentication can only be configured by using the Remote UI. [▶Configuring E-Mail Communication Settings\(P. 82\)](#)

**5 Click [Next].**

**6 Confirm the settings and click [Register].**

**7 Restart the machine.**

- Turn OFF the machine, wait for at least 10 seconds, and turn it back ON.

**IMPORTANT**

Additional settings may be required depending on the network you are using. For more information, contact your Internet service provider or Network Administrator.

- To enable TLS for e-mailing, see [▶Configuring E-Mail Communication Settings\(P. 82\)](#) .
- To change port numbers, see [▶Changing Port Numbers\(P. 305\)](#) .

**LINKS**

- ▶[Procedure for Setting to Send E-Mail\(P. 78\)](#)
- ▶[Specifying E-Mail Settings\(P. 259\)](#)
- ▶[Registering Destinations\(P. 161\)](#)



# Configuring E-Mail Communication Settings

2KUU-01L

Use the Remote UI to configure the detailed send settings, such as the settings for POP authentication and encryption of communication before you send e-mail. Contact your provider or network administrator for the required settings.

## NOTE

- For more information about the basic operations to be performed when setting the machine from the Remote UI, see [▶Setting Up Menu Options from Remote UI\(P. 344\)](#) .

- 1 Start the Remote UI and log in to System Manager Mode. ▶Starting Remote UI(P. 335)**
- 2 Click [Settings/Registration] on the Portal page. ▶Remote UI Screen(P. 336)**
- 3 Select [Network Settings] ▶ [E-Mail Settings].**
- 4 Click [Edit].**
- 5 Specify the required settings.**

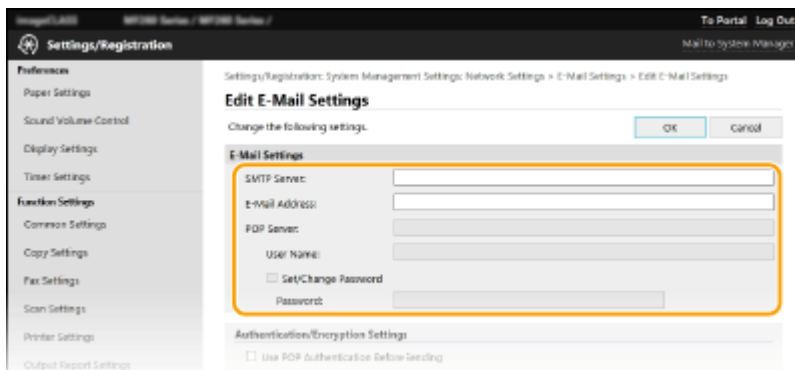

### [SMTP Server]

Enter alphanumeric characters as the SMTP server name (or IP address) for sending e-mail.

### [E-Mail Address]

Enter alphanumeric characters for the e-mail address that you want to use for the machine.

### [POP Server]

Enter alphanumeric characters as the POP3 server name or IP address for sending e-mail.

### [User Name]

Enter alphanumeric characters as the user name for the specified e-mail account when a POP3 server is used.

### [Set/Change Password]

To set or change the password when a POP3 server is used, select the check box and enter alphanumeric characters in [Password].

### ■ Configuring Pop Authentication before Sending

POP before SMTP authentication prevents unauthorized users from using e-mail by performing user authentication on the POP3 server.

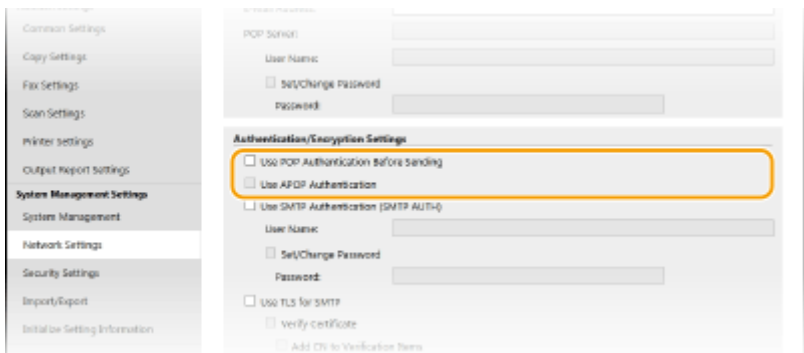

#### [Use POP Authentication Before Sending]

To use the POP3 server for authentication before you send e-mail, select the check box.

#### [Use APOP Authentication]

Select the check box to use APOP to encrypt the password during the authentication process.

### ■ Configuring SMTP authentication

If you configure SMTP authentication (SMTP AUTH), user identification by user name and password is performed at the time of sending e-mail.

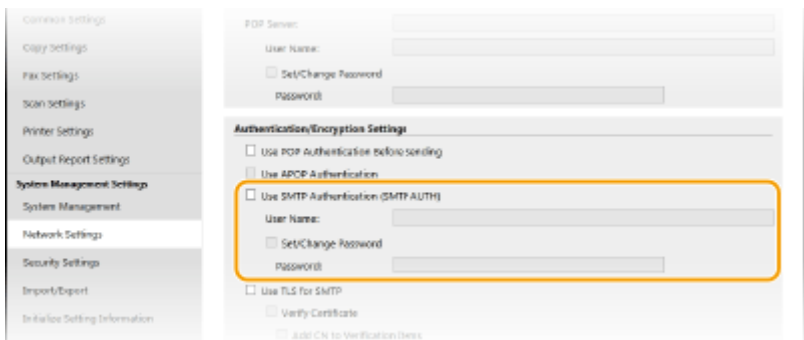

#### [Use SMTP Authentication (SMTP AUTH)]

To enable authentication on the SMTP server, select the check box and enter alphanumeric characters in the [User Name] text box.

#### [Set/Change Password]

To specify or change the password, enter alphanumeric characters in the [Password] text box.

### ■ Configuring encrypted communication

You can configure encryption of communication with an SMTP or POP3 server.

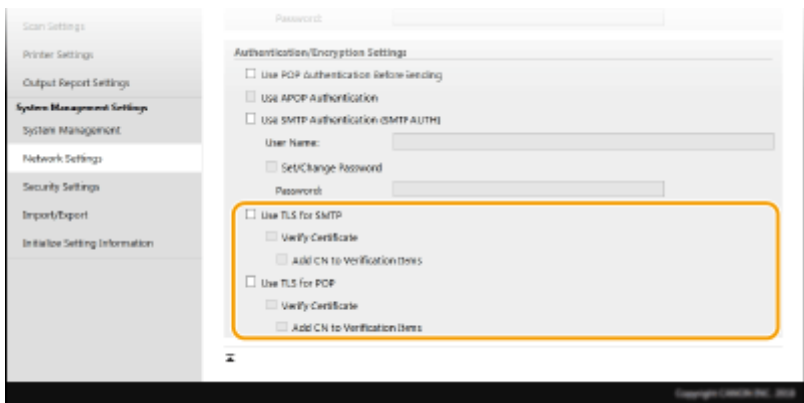

**[Use TLS for SMTP]**

Select the check box to use TLS for encrypting communication with the SMTP server. Select the check box for [Verify Certificate] or [Add CN to Verification Items] depending on your needs.

**[Use TLS for POP]**

Select the check box to encrypt communication with the POP3 server using TLS. Select the [Verify Certificate] and [Add CN to Verification Items] check boxes as required.

**6** Click [OK].

## IMPORTANT

- Depending on the network you are using, you may need to change the SMTP or POP3 port setting ( [▶ Changing Port Numbers\(P. 305\)](#) ). For more information, contact your Internet service provider or Network Administrator.

### LINKS

---

- ▶ [Procedure for Setting to Send E-Mail\(P. 78\)](#)
- ▶ [Configuring Basic E-Mail Settings\(P. 79\)](#)
- ▶ [Basic Operations for Scanning Originals\(P. 233\)](#)

# Procedure for Setting a Shared Folder as a Save Location

Before configuring the machine for scanning to shared folders, check the setup flow shown below.

1



**Make sure that the machine and the computer are correctly connected.**

- ▶ **Connecting to a Wireless LAN(P. 18)**
- ▶ **Connecting to a Wired LAN(P. 17)**



2



**Make sure that you have the following information:**

- The IP address of the machine. ▶ **Viewing Network Settings(P. 38)**
- The name of the computer where the shared folder is located. ▶ **Checking the Computer Name(P. 560)**
- Path to and the name of the shared folder (If access restrictions are set to the folder, the user name and password information is also needed).

### NOTE:

- For instructions on how to create a new shared folder, see "Send Setting Guide" (included with the provided CD-ROM/DVD-ROM).



3



**Make sure that the computer meets the system requirements for the Send Function Setting Tool.**

- System requirements for the Send Function Setting Tool ▶ **System Environment(P. 546)**

### NOTE:

- Also make sure that <Use HTTP> and <Use Remote UI> are set to <On>.
  - ▶ **Disabling HTTP Communication(P. 332)**
  - ▶ **Disabling Remote UI(P. 333)**



4



**Set the machine configuration.** ▶ **Setting a Shared Folder as a Save Location(P. 86)**

# Setting a Shared Folder as a Save Location

2KUU-01S

The feature of scanning to shared folders is also called "Scan to SMB" because the feature uses Server Message Block (SMB), a Windows-specific technology. SMB is a protocol for sharing resources, such as files and printers, with more than one device in a network ( [▶Configuring SMB\(P. 61\)](#) ). To configure the machine for saving your scanned documents into a shared folder in the network via SMB, specify the location of the shared folder from a computer in advance. This section describes how to specify the save location by using the Send Function Setting Tool.

## NOTE

- You can also use the Remote UI to specify the location of the shared folder as save destination by registering the folder to the Address Book. Registering Destinations in the Address Book from Remote UI. [▶Registering Destinations from Remote UI\(P. 347\)](#)

## 1 Start the Send Function Setting Tool.

### ■Using a Web browser

Enter "http://<the IP address of the machine>/sendsupport\_login.html" in the address field of a Web browser, and press the [ENTER] key.

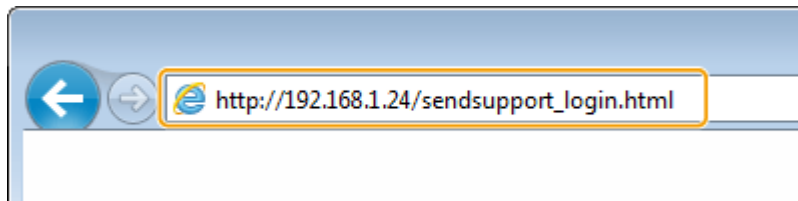

### ■Using the CD-ROM/DVD-ROM

- 1 Insert the provided CD-ROM/DVD-ROM into the drive on the computer.
  - Select a language and click [OK] if you are prompted to do so.
- 2 Click [Start Software Programs].

## NOTE:

- If the [Software Programs/Manuals Setup] screen is not displayed, see [▶Displaying the \[Software Programs/Manuals Setup\] Screen\(P. 558\)](#) .
- If [AutoPlay] is displayed, click [Run MInst.exe].

- 3 Click [Start] for [Send Function Setting Tool].
- 4 Click [Next].
  - If you want to view "Send Setting Guide," click [How to Set].

## NOTE:

- If the screen that cancels the Windows firewall is displayed, click [Yes].

- 5 Select the machine from [Device List] and click [Next].

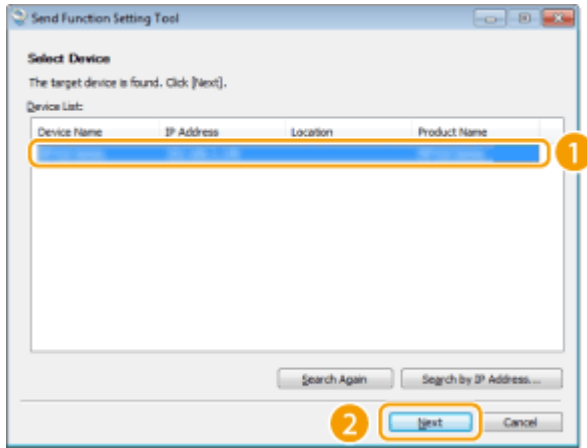

**NOTE:**

If the machine is not displayed in [Device List]

- Click [Search Again]. If the problem persists, click [Search by IP Address], enter the IP address of the machine, and then click [OK].

6 Confirm the settings and click [OK].

**2 Click [Start].**

- If the login screen is displayed, enter the appropriate PIN in the corresponding text boxes, and then click [Logon].

**3 Click [Store to Shared Folder Settings].**

- If the screen prompting you to enter the Address Book PIN is displayed, enter the PIN for the Address Book, and click [OK]. **Restricting Use of the Address Book(P. 325)**

**4 Specify the required settings.**

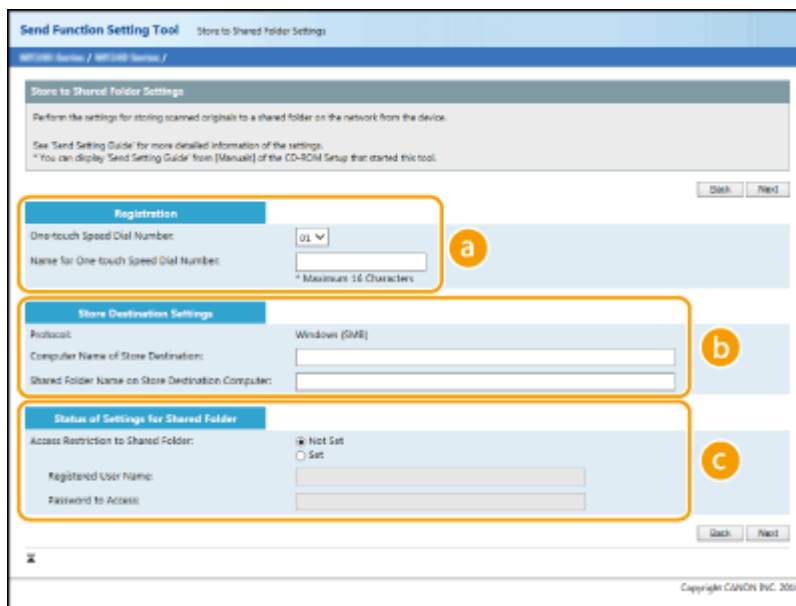

**a [Registration]**

**[One-touch Speed Dial Number]**

With the Send Function Setting Tool, you can register a shared folder for saving scanned documents into <One-Touch> in the Address Book. Select a number from the drop-down list.

**[Name for One-touch Speed Dial Number]**

Enter the name for identifying the destination to be registered. Set a name that will be easy for you to find later in the Address Book.

**b [Store Destination Settings]**

**[Protocol]**

The protocol that is used for sending scanned documents to a shared folder is displayed.

**[Computer Name of Store Destination]**

Enter the name or the IP address of the computer where the shared folder is located.

**[Shared Folder Name on Store Destination Computer]**

Enter the name of (or path to) the shared folder. For example, if the shared folder is a subfolder named "share" and is contained in the [Public] folder in drive C (path: C:\users\public\share), enter "users\public\share."

**c [Status of Settings for Shared Folder]**

**[Access Restriction to Shared Folder]**

Click the [Not Set] or [Set] radio button to match the access restrictions set to the shared folder. When [Set] is selected, enter the user name in the [Registered User Name] text box and password in the [Password to Access] text box.

**5 Click [Next].**

**6 Confirm the settings and click [Register].**

**7 Restart the machine.**

- Turn OFF the machine, wait for at least 10 seconds, and turn it back ON.

**LINKS**

---

▶ **Procedure for Setting a Shared Folder as a Save Location(P. 85)**

▶ **Basic Operations for Scanning Originals(P. 233)**

# Basic Operations

<b>Basic Operations</b> .....	91
<b>Parts and Their Functions</b> .....	94
Front Side .....	95
Back Side .....	97
Interior .....	98
Feeder .....	99
Multi-Purpose Tray .....	100
Drawer .....	101
Operation Panel .....	102
<b>Turning ON the Machine</b> .....	107
Turning OFF the Machine .....	108
<b>Using the Operation Panel</b> .....	109
Basic Screens .....	110
Home Screen .....	111
<Status Monitor> Screen .....	115
Message Display .....	117
Basic Operation .....	118
Entering Text .....	123
<b>Placing Originals</b> .....	128
<b>Loading Paper</b> .....	132
Loading Paper in the Drawer .....	134
Loading Paper in the Multi-Purpose Tray .....	138
Loading Envelopes .....	141
Loading Preprinted Paper .....	143
Specifying Paper Size and Type .....	145
Specifying Paper Size and Type in the Drawer .....	146
Specifying Paper Size and Type in the Multi-Purpose Tray .....	147
Registering a Custom Paper Size .....	148
Limiting the Paper Sizes Displayed .....	150
<b>Customizing the Display</b> .....	151
Customizing the Home Screen .....	152
<b>Changing the Default Settings for Functions</b> .....	154
<b>Setting Sounds</b> .....	155
<b>Entering Quiet Mode</b> .....	157



<b>Entering Sleep Mode</b> .....	159
<b>Registering Destinations</b> .....	161
Registering Destinations in the Address Book .....	163
Registering Destinations for One-Touch Dial .....	165
Registering Multiple Destinations as a Group .....	167
Editing the Registered Destinations in the Address Book .....	169

# Basic Operations

---

2KUU-01U

This chapter describes basic operations, such as how to use the operation panel or how to load the paper, that are frequently performed to use the functions of the machine.

## ■ Parts and Their Functions

This section describes the exterior and interior parts of the machine and their functions, as well as how to use the keys on the operation panel and how to view the display. ▶ **Parts and Their Functions(P. 94)**



## ■ Turning ON the Machine

This section describes how to turn the machine ON and OFF. ▶ **Turning ON the Machine(P. 107)**



## ■ Using the Operation Panel

This section describes how to use the display for tasks such as selecting items and adjusting settings. Also, it describes how to enter characters and numbers. ▶ **Using the Operation Panel(P. 109)**

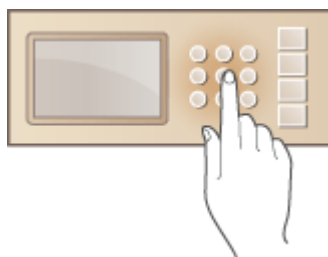

## ■ Placing Originals

This section describes how to place originals on the platen glass and in the feeder. ▶ **Placing Originals(P. 128)**



### ■ Loading Paper

This section describes how to load the paper into the drawer. ▶ **Loading Paper(P. 132)**

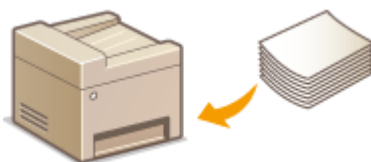

### ■ Customizing the Display

This section describes how to rearrange buttons or create shortcut buttons in order to make it easier to use screens shown in the display. ▶ **Customizing the Display(P. 151)**

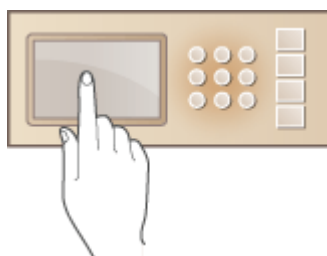

### ■ Entering Quiet Mode

This section describes how to place the machine in quiet mode to reduce operation sound. ▶ **Entering Quiet Mode(P. 157)**



### ■ Entering Sleep Mode

This section describes how to set the sleep mode. ▶ **Entering Sleep Mode(P. 159)**



## ■ Registering Destinations

This section describes how to register destinations for sending faxes or scanned documents. **▶ Registering Destinations(P. 161)**

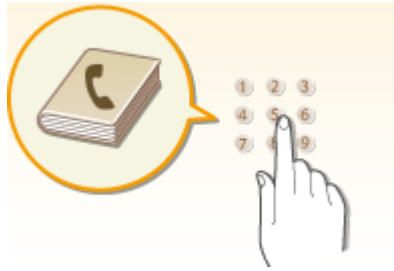

## Parts and Their Functions

---

2KUU-01W

This section describes the parts of the machine (exterior, front and back side, and interior) and how they function. In addition to describing the parts of the machine used for such basic operations as loading paper and replacing the toner cartridges, etc., this section also describes the keys on the operation panel and display. Read this section for tips on how to use the machine properly.



- ▶ **Front Side(P. 95)**
- ▶ **Back Side(P. 97)**
- ▶ **Interior(P. 98)**
- ▶ **Feeder(P. 99)**
- ▶ **Multi-Purpose Tray(P. 100)**
- ▶ **Drawer(P. 101)**
- ▶ **Operation Panel(P. 102)**

## Front Side

2KUU-01X

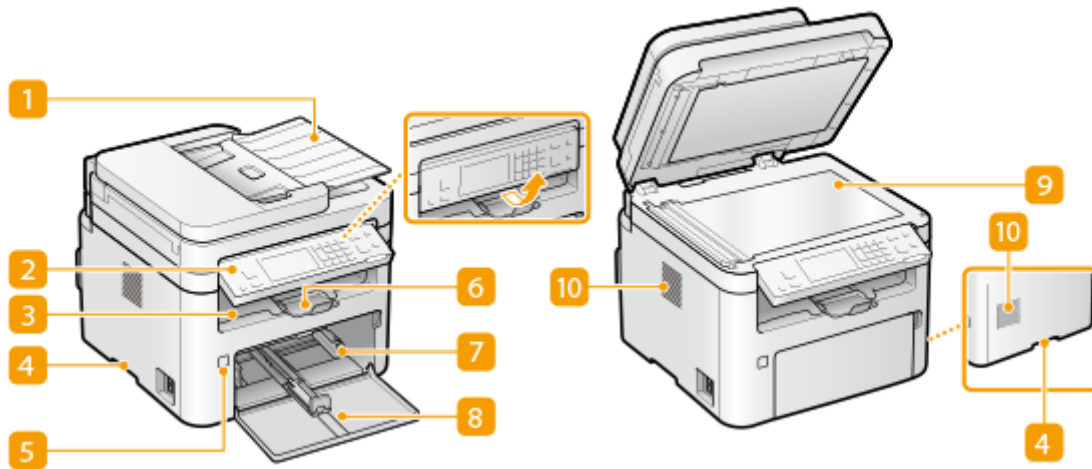

### 1 Feeder

Automatically feeds originals into the machine for scanning. When two or more sheets of original are loaded in the feeder, originals can be scanned continuously. ▶ **Feeder(P. 99)**

### 2 Operation panel

The operation panel consists of keys such as Stop key, a display, and status indicators. You can perform all the operations and specify settings from the operation panel.

▶ **Operation Panel(P. 102)**

▶ **Basic Screens(P. 110)**

### 3 Output tray

Printed paper is output to the output tray.

### 4 Lift handles

Hold the lift handles when carrying the machine. ▶ **Relocating the Machine(P. 452)**

### 5 Power switch

Turns the power ON or OFF. To restart the machine, turn OFF the machine, wait for at least 10 seconds, and turn it back ON.

### 6 Paper stopper

Open the paper stopper when you want to prevent paper from falling out of the output tray.

### 7 Drawer

Load the type of paper you frequently use into the drawer. ▶ **Loading Paper in the Drawer(P. 134)**

### **8 Front cover**

Open the front cover when replacing toner cartridge or drum cartridge. ▶ **Procedure for Replacing the Toner Cartridge(P. 444)**

### **9 Platen glass**

When scanning books, originals of heavy or thin paper and other originals that cannot be scanned using the feeder, place them on the platen glass. ▶ **Placing Originals(P. 128)**

### **10 Ventilation slots**

Air inside the machine is vented out to cool down the inside of the machine. Note that placing objects in front of the ventilation slots prevents ventilation.

## Back Side

2KUU-01Y

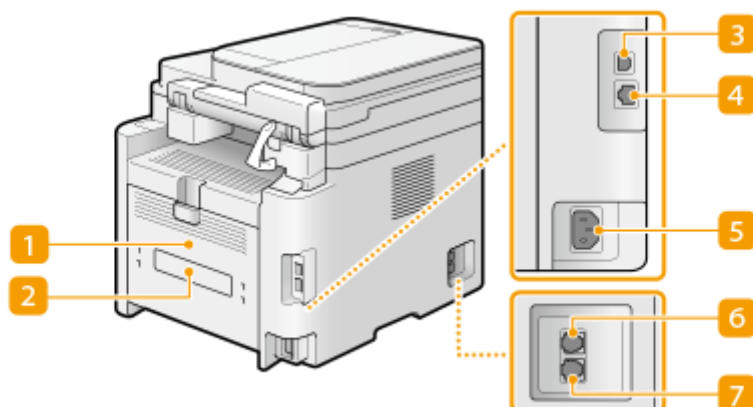

### 1 Back cover

Open the back cover when clearing paper jams. ▶ **Clearing Paper Jams(P. 510)**

### 2 Rating label

The label shows the serial number, which is needed when making inquiries about the machine. ▶ **When a Problem Cannot Be Solved(P. 518)**

### 3 USB port

Connect a USB cable when connecting the machine and a computer.

### 4 LAN port

Connect a LAN cable when connecting the machine to a wired LAN router, etc. ▶ **Connecting to a Wired LAN(P. 17)**

### 5 Power socket

Connect the power cord.

### 6 External telephone jack

Connect your telephone or answering machine. ▶ **Connecting the Telephone Line(P. 74)**

### 7 Telephone line jack

Connect a telephone cable when connecting the machine to a telephone line. ▶ **Connecting the Telephone Line(P. 74)**



# Interior

---

2KUU-020

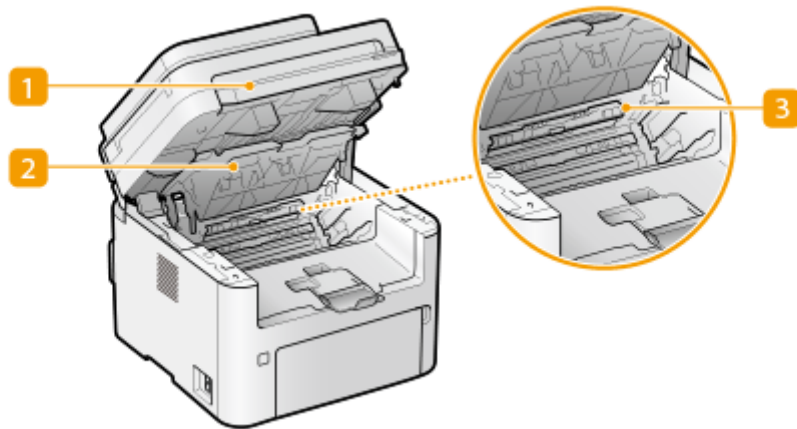

## 1 Operation panel

Lift this panel to replace the toner cartridge, etc., or clear paper jams.

- ▶ [Replacing the Toner Cartridge\(P. 443\)](#)
- ▶ [Replacing the Drum Cartridge\(P. 447\)](#)
- ▶ [Paper Jams inside the Machine\(P. 514\)](#)

## 2 Toner cover

Open this cover to replace the toner cartridge, etc., or clear paper jams.

- ▶ [Replacing the Toner Cartridge\(P. 443\)](#)
- ▶ [Replacing the Drum Cartridge\(P. 447\)](#)
- ▶ [Paper Jams inside the Machine\(P. 514\)](#)

## 3 Paper exit guide

Open this guide to clear paper jams. ▶ [Paper Jams inside the Machine\(P. 514\)](#)

## LINKS

---

- ▶ [Replacing the Toner Cartridge\(P. 443\)](#)
- ▶ [Replacing the Drum Cartridge\(P. 447\)](#)

## Feeder

2KUU-021

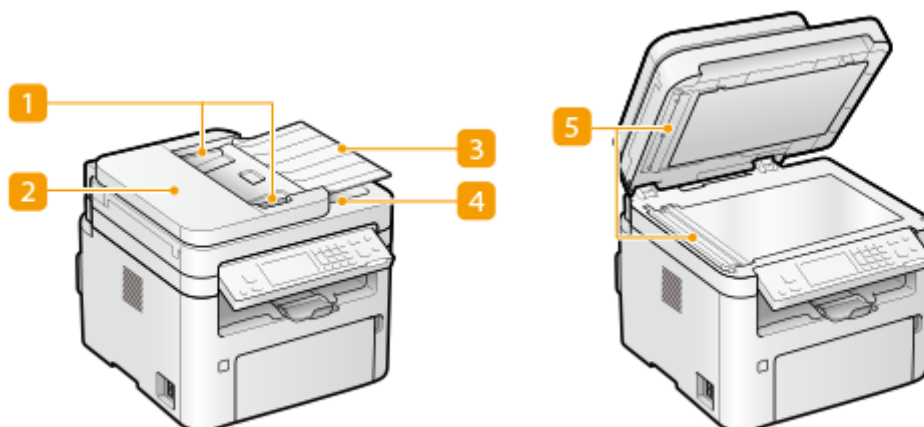

### 1 Slide guides

Adjust these guides to match the width of original.

### 2 Feeder cover

Open when clearing paper jams. ▶ **Paper Jams in the Feeder(P. 511)**

### 3 Original supply tray

Automatically feeds originals into the machine for scanning. When two or more sheets of original are loaded in the feeder, originals can be scanned continuously. ▶ **Placing Originals(P. 128)**

### 4 Original output tray

Scanned originals are output here.

### 5 Original scanning area

Originals loaded in the feeder are automatically fed to the original scanning area to be scanned.

## IMPORTANT

- Do not place any objects in the original output area. Doing so may cause damage to the originals.
- Regularly clean the feeder and platen glass in order to obtain proper print results. ▶ **Regular Cleaning(P. 432)**

## Multi-Purpose Tray

---

2KUU-022

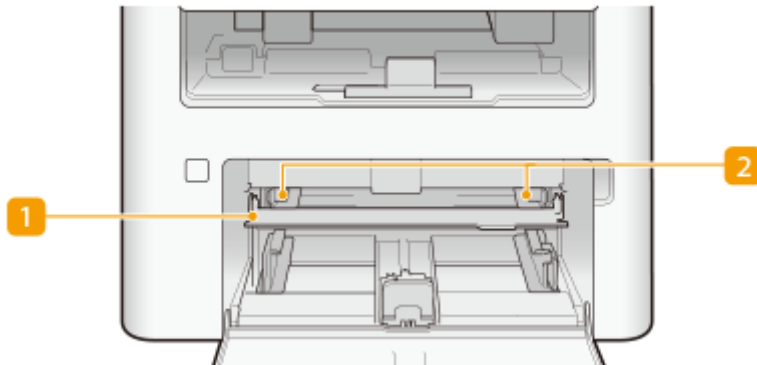

### **1** Multi-Purpose Tray

Lower the multi-purpose tray when loading paper.

### **2** Paper guides

Adjust the paper guides to exactly the width of the loaded paper to ensure that paper is fed straight into the machine.

## LINKS

---

➤ [Loading Paper in the Multi-Purpose Tray\(P. 138\)](#)

## Drawer

---

2KUU-023

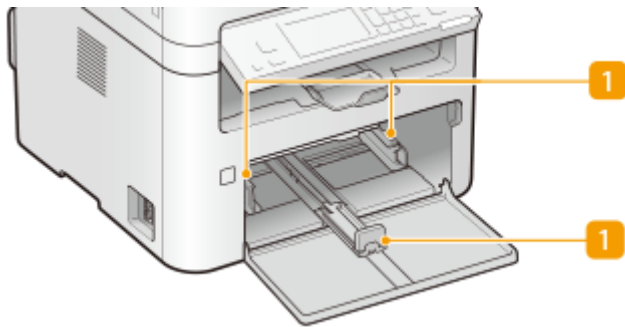

### **1** Paper guides

Adjust the paper guides to exactly the size of the loaded paper to ensure that paper is fed straight into the machine.

### LINKS

---

➤ [Loading Paper in the Drawer\(P. 134\)](#)

# Operation Panel

- ▶ Operation Panel of Touch Panel Model(P. 102)
- ▶ Operation Panel of 5 Lines LCD Model(P. 104)

## Operation Panel of Touch Panel Model

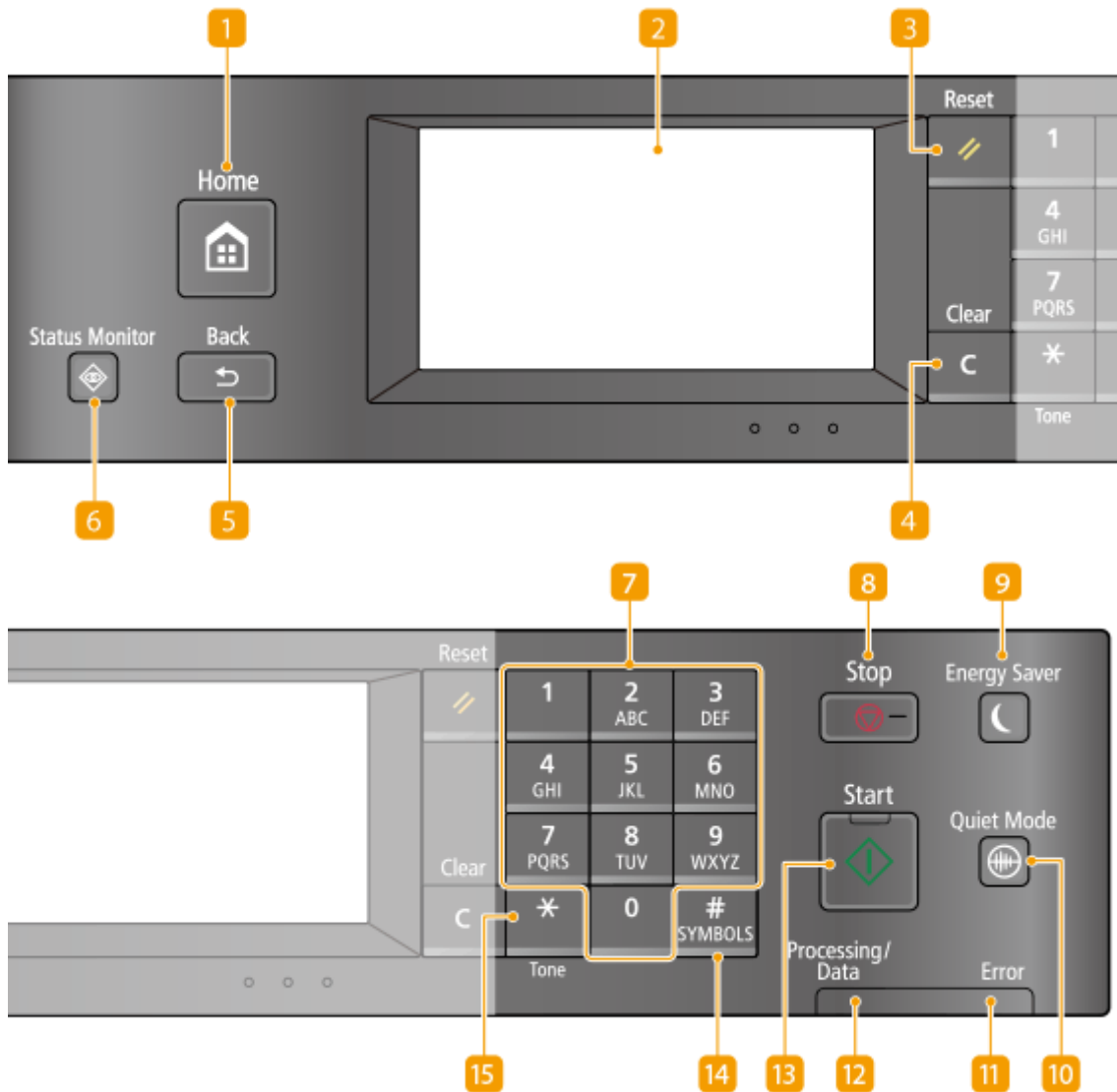

### 1 [Home] key

Press to display the Home screen, which provides access to the setting menu and functions such as copy and scan.

- ▶ Home Screen(P. 111)
- ▶ Customizing the Home Screen(P. 152)

### 2 Display

You can view the progress of the machine and error statuses. The display is also a touch panel, so you can specify settings by touching the screen directly.

- ▶ Basic Screens(P. 110)
- ▶ Basic Operation(P. 118)

**3 [Reset] key**

Press to cancel the settings and restore the previously specified settings.

**4 [Clear] key**

Press to delete the entered numbers and text.

**5 [Back] key**

Press to return to the previous screen. If you press this key when specifying settings, for example, the settings are not applied and the display returns to the previous screen.

**6 [Status Monitor] key**

Press to check the status of printing or faxing, to view the usage history, or to view the network settings such as the IP address of the machine. You can also check the status of the machine, such as the paper size and the amount remaining in the toner cartridge, etc., or whether any errors occurred. ▶<Status Monitor> Screen(P. 115)

**7 Numeric keys ([0]-[9] keys)**

Press to enter numbers and text. ▶Entering Text(P. 123)

**8 [Stop] key**

Press to cancel printing and other operations.

**9 [Energy Saver] key**

Press to put the machine into sleep mode. The key lights up green when the machine is in sleep mode. Press the key again to exit sleep mode. ▶Entering Sleep Mode(P. 159)

**10 [Quiet Mode] key**

Press to put the machine into quiet mode. While in quiet mode this key is lit in green. Press the key again to exit quiet mode. ▶Entering Quiet Mode(P. 157)

**11 [Error] indicator**

Blinks or lights up when an error such as a paper jam occurs.

**12 [Processing/Data] indicator**

Blinks while operations such as sending or printing are being performed. Lights up when there are documents waiting to be processed.

**13 [Start] key**

Press to scan or copy originals.

**14 [#] key**

Press to enter symbols such as "@" or "/".

**15 [\*] key**

Press to switch the type of text that is entered.

Operation Panel of 5 Lines LCD Model

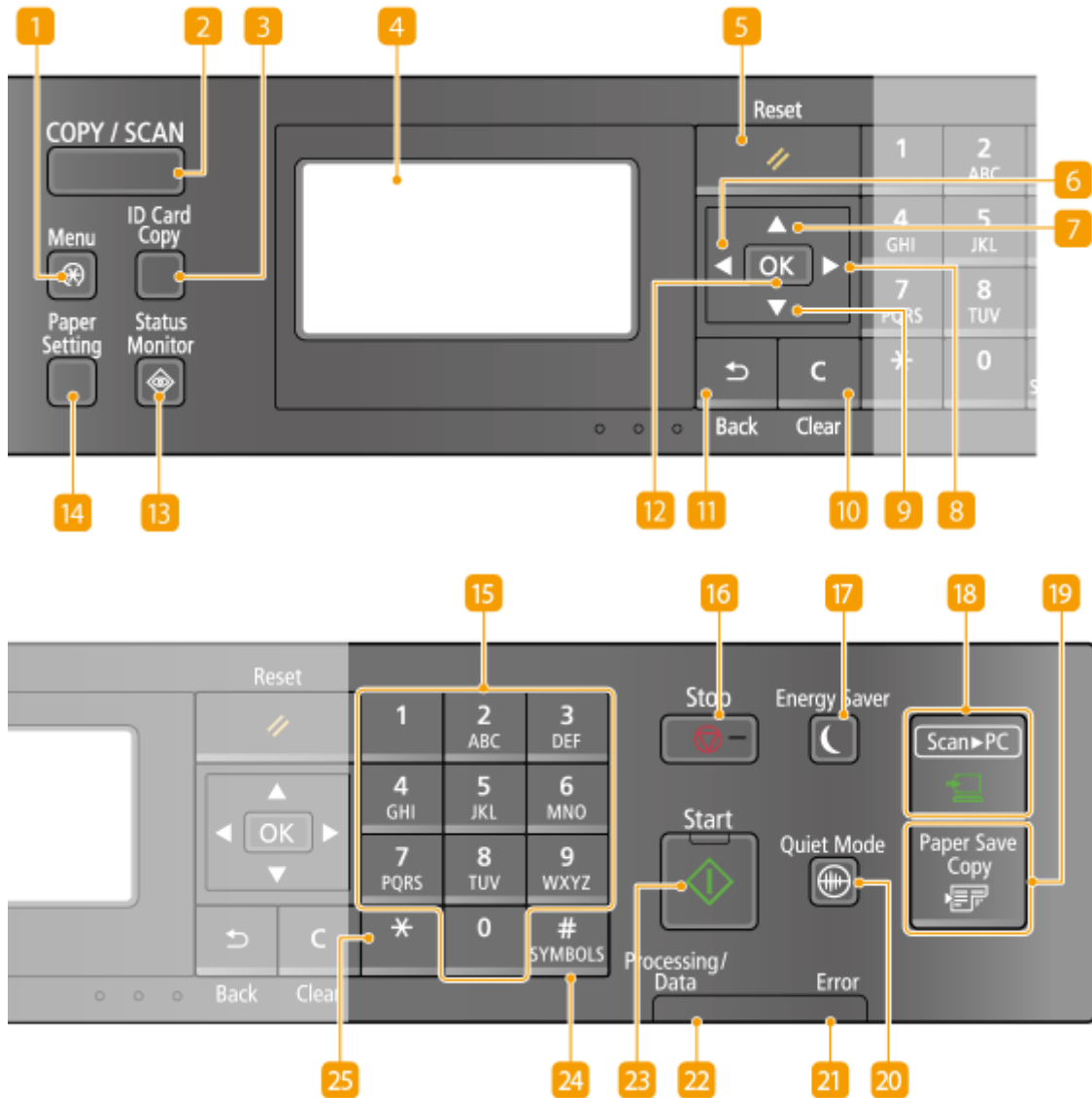

**1 [Menu] key**

Press to start specifying many of the settings for the machine, such as <Timer Settings> or <Preferences>. ▶ **Setting Menu List(P. 361)**

**2 [COPY/SCAN] key**

Press to switch the mode to copy or scan.

**3 [ID Card Copy] key**

Press to enter a mode for copying the front and back sides of a driver's license or other ID card onto the same side of a page at actual size. ▶ **Making ID Card Copies(P. 189)**

**4 Display**

You can view the operation and error statuses of this machine, the amount remaining in the toner cartridge, etc., and other conditions.

▶ **Basic Screens(P. 110)**

▶ **Basic Operation(P. 118)**

**5 [Reset] key**

Press to cancel the settings and restore the previously specified settings.

**6 [ ◀ ] key**

When specifying settings, press to return to the previous screen. When entering numbers, press to move the cursor to the left.

**7 [ ▲ ] key**

When specifying settings, press to select the item immediately above the currently selected item. When changing setting values, press to increase a value.

**8 [ ▶ ] key**

When specifying settings, press to proceed to the next screen. When entering numbers, press to move the cursor to the right.

**9 [ ▼ ] key**

When specifying settings, press to select the item immediately below the currently selected item. When changing setting values, press to decrease a value.

**10 [Clear] key**

Press to delete the entered numbers and text.

**11 [Back] key**

Press to return to the previous screen. If you press this key when specifying settings, for example, the settings are not applied and the display returns to the previous screen.

**12 [  ] key**

Press to apply settings or specified details.

**13 [Status Monitor] key**

Press to check the printing status, to view the usage history, or to view the network settings such as the IP address of the machine. You can also check the status of the machine, such as the paper size and the amount remaining in the toner cartridge, etc., or whether any errors occurred. ▶ **<Status Monitor> Screen(P. 115)**

**14 [Paper Setting] key**

Press to select the paper you want to use, or to set the size and type of paper loaded in the paper source. ▶ **Specifying Paper Size and Type(P. 145)**



**15 Numeric keys ([0]-[9] keys)**

Press to enter numbers and text. ▶ **Entering Text(P. 123)**

**16 [Stop] key**

Press to cancel printing and other operations.

**17 [Energy Saver] key**

Press to put the machine into sleep mode. The key lights up green when the machine is in sleep mode. Press the key again to exit sleep mode. ▶ **Entering Sleep Mode(P. 159)**

**18 [Scan -> PC] key**

Press to send the scanned documents to the registered computer. ▶ **Scanning Using the Shortcut Key(P. 236)**

**19 [Paper Save Copy] key**

Press to put the machine into paper save copy mode for copying multiple document pages reduced on a single sheet. ▶ **Using <Paper Save Copy>(P. 187)**

**20 [Quiet Mode] key**

Press to put the machine into quiet mode. While in quiet mode this key is lit in green. Press the key again to exit quiet mode. ▶ **Entering Quiet Mode(P. 157)**

**21 [Error] indicator**

Blinks or lights up when an error such as a paper jam occurs.

**22 [Processing/Data] indicator**

Blinks while operations such as sending or printing are being performed. Lights up when there are documents waiting to be processed.

**23 [Start] key**

Press to scan or copy originals.

**24 [#] key**

Press to enter symbols such as "@" or "/".

**25 [\*] key**

Press to switch the type of text that is entered.

LINKS

---

▶ **Basic Operation(P. 118)**

## Turning ON the Machine

---

2KUU-025

This section describes how to turn ON the machine.

- 1 Make sure that the power plug is firmly inserted into a power outlet.**
- 2 Press the power switch.**

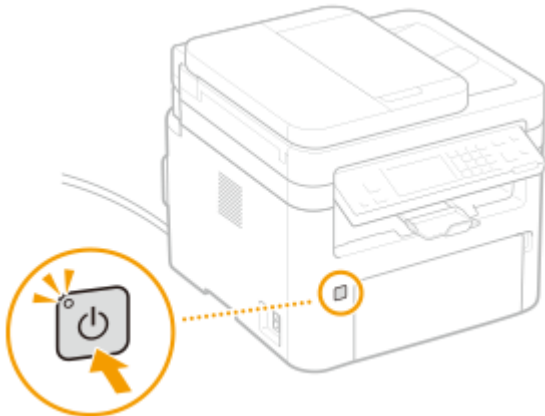

⇒ The Start screen appears. ▶ **Operation Panel(P. 102)**

### NOTE

- A blank sheet of paper may be output when you turn ON the power for the first time after purchasing the machine. This is not a malfunction.
- On the touch panel model, you can select the screen that is displayed first after the machine is turned ON. ▶ **<Default Screen after Startup/Restoration>(P. 377)**

### LINKS

---

▶ **Turning OFF the Machine(P. 108)**

## Turning OFF the Machine

2KUU-026

This section describes how to turn OFF the machine.

### 1 Press the power switch.

- Make sure that the power indicator has gone out.

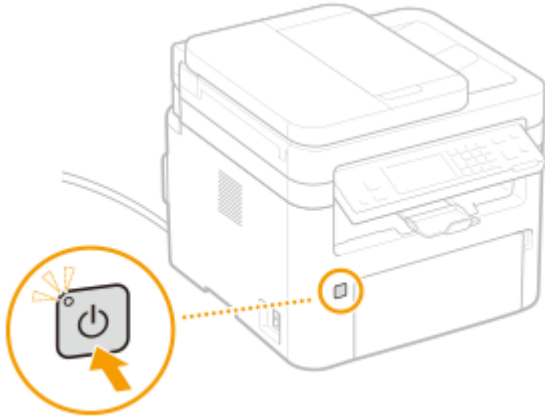

### NOTE

- It may take some time for the machine to completely shut down. Do not unplug the power cord until the display turns off.
- To restart the machine, wait for at least 10 seconds after the machine is turned OFF.
- Even when the power is turned OFF, the machine continues to consume a small amount of power. To reduce power consumption to zero, unplug the power plug from the AC power outlet.

## Using the Operation Panel

---

2KUU-027

You can use the display and keys of the operation panel to configure machine settings or operate functions. This section describes basic usage of the display and keys.

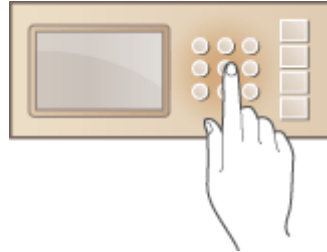

- ▶ **Basic Screens(P. 110)**
- ▶ **Basic Operation(P. 118)**
- ▶ **Entering Text(P. 123)**

### TIPS

- If you want to invert the light and dark parts of the display: ▶ **<Invert Screen Colors>(P. 377)**
- If you want to adjust the contrast of the display: ▶ **<Contrast>(P. 377)**

### LINKS

---

- ▶ **Operation Panel(P. 102)**

## Basic Screens

---

2KUU-028

The Home screen or settings screen appears on the display, allowing you to initiate functions such as copy and scan. You can also use the display to check information such as error messages and the machine's operation status. The screen is also a touch panel, so you can perform operations by touching the screen directly.

- ▶ **Home Screen(P. 111)**
- ▶ **<Status Monitor> Screen(P. 115)**
- ▶ **Message Display(P. 117)**

### NOTE

#### For the Touch Panel Model

- You can customize the Home screen by rearranging frequently used buttons for easier access to the respective functions. ▶ **Customizing the Home Screen(P. 152)**

# Home Screen

- ▶ Home Screen (Touch Panel Model)(P. 111)
- ▶ Main Screen (5 Lines LCD Model)(P. 113)

## Home Screen (Touch Panel Model)

The Home screen is displayed when the power is turned ON or by pressing  on the operation panel. Use this screen to specify settings for and register functions.

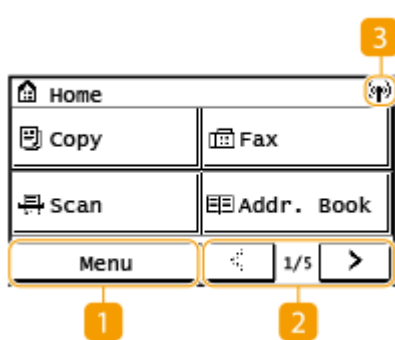

### 1 <Menu>

<Timer Settings>, <Preferences>, and many other machine settings start from this button. ▶ **Setting Menu List(P. 361)**

### 2 Change page

Use this to view another page in the Home screen.

### 3 Wi-Fi icon

Displayed when the machine is connected to a wireless LAN.

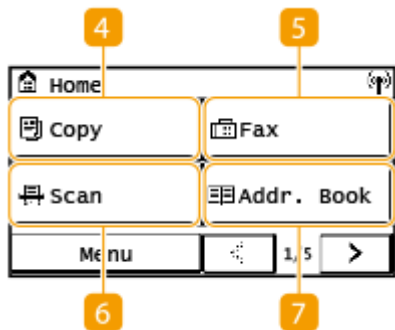

### 4 <Copy>

Use this button to start copying. ▶ **Copying(P. 171)**

### 5 <Fax>

Use this button to send a fax from the machine. ▶ **Faxing(P. 193)**

### 6 <Scan>

Scans an original and converts it into an electronic file. You can save scanned files on your computer or send them via e-mail. ▶ **Scanning(P. 231)**

### 7 <Addr. Book>

Use this to register or edit the destinations for e-mails and faxes. You can also display a registered destination when sending an e-mail or fax. ▶ **Registering Destinations(P. 161)**

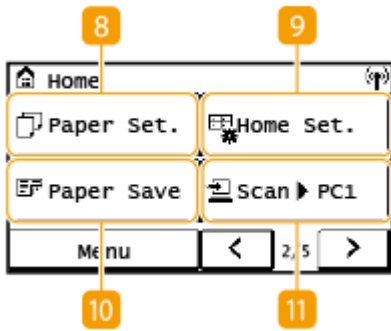

**8 <Paper Set.>**

This button is used for specifying the size and type of paper loaded in the drawer and multi-purpose tray. **▶Specifying Paper Size and Type(P. 145)**

**9 <Home Set.>**

Allows you to change the order that Home screen buttons are displayed in. **▶Customizing the Home Screen(P. 152)**

**10 <Paper Save>**

Settings are preregistered for economically copying 2 pages (or 4 pages) reduced on a single sheet. **▶Using <Paper Save Copy>(P. 187)**

**11 <Scan -> PC1> / <Scan -> PC2>**

By registering scan settings beforehand, you can simply select this button to start a scan. **▶Scanning Using the Shortcut Key(P. 236)**

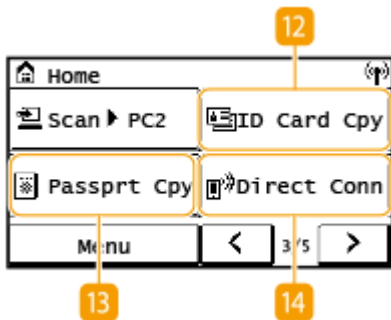

**12 <ID Card Cpy>**

Use this function to copy the front and back sides of a driver's license or other card onto the same side of one sheet of paper. **▶Making ID Card Copies(P. 189)**

**13 <Passprt Cpy>**

Use this function to copy passports for several individuals laid out on a single sheet of paper. **▶Making Passport Copy(P. 190)**

**14 <Direct Conn>**

Use this to establish a connection to a mobile device. **▶Connecting with Mobile Devices(P. 267)**

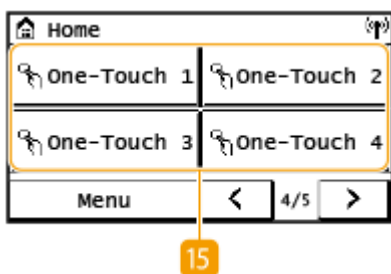

**15 <One-Touch 1> to <One-Touch 4>**

If you register destinations beforehand as One-Touch Dial numbers, they can be quickly displayed. **▶Registering Multiple Destinations as a Group(P. 167)**

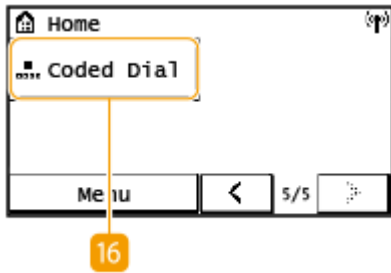

### 16 <Coded Dial>

If you register destinations beforehand as coded dial numbers, they can be quickly displayed by simply entering a three-digit number. ▶ **Registering Destinations in the Address Book(P. 163)**

## Main Screen (5 Lines LCD Model)

The main screen shows the screens for copying, scanning, and other functions, as well as the screens for specifying settings for these functions.

### Copy Main Screen / Scan Main Screen

When you press  (COPY/SCAN) the main screen for the selected function is displayed. The copy main screen is shown below as an example.

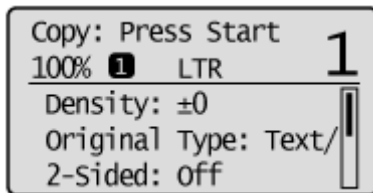

▶ **Basic Copy Operations(P. 173)**

▶ **Basic Operations for Scanning Originals(P. 233)**

### <Paper Settings> Screen

When you press  (Paper Setting) to select the paper to copy or print on, the <Paper Settings> screen is displayed. Select the paper on the screen. Also, for example, you can press this key to change the paper settings when you load a paper size that is different from the previously loaded paper size. Note that the paper setting must be correctly specified so that the paper is fed properly.

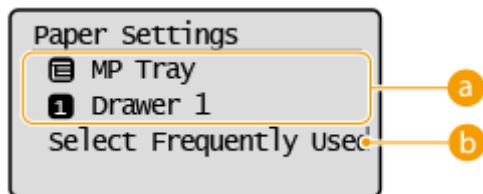

#### a Selecting Paper Tray

Use to select the paper for each tray. ▶ **Specifying Paper Size and Type(P. 145)**

#### b <Select Frequently Used Paper Sizes>

You can set the machine to display only frequently used paper sizes in the selection screen.

### <Menu> Screen

When you press , the <Menu> screen is displayed. On this screen, you can start specifying general machine settings such as <Preferences> or <Timer Settings>, as well as many of the settings for each function, such as copy and scan.



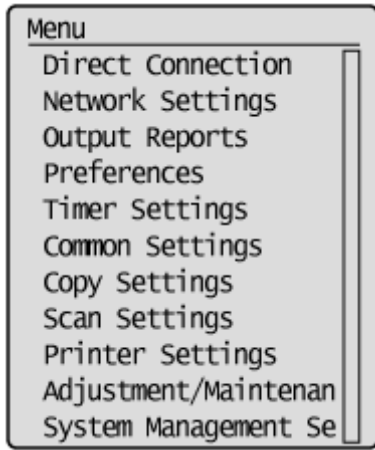

▶ **Setting Menu List(P. 361)**

## LINKS

---

▶ **Customizing the Home Screen(P. 152)**

## <Status Monitor> Screen

2KUU-02A

When you press , a screen appears in which you can check the progress of document processing as well as the status of the machine (the amount of toner remaining in the toner cartridges, etc.) and network settings such as the machine's IP address.

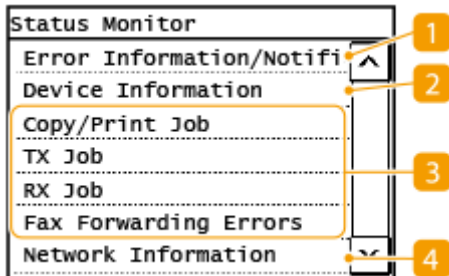

### 1 <Error Information/Notification>

Displays the details of any errors that occurred.  **Countermeasures for Each Message(P. 491)**

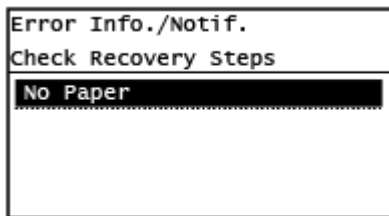

### 2 <Device Information>

Displays the status of the machine, such as the paper size or the amount of toner remaining in the toner cartridges.

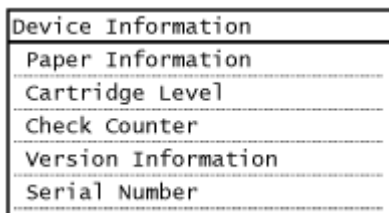

#### <Paper Information>

Displays whether paper is loaded in each paper source.

#### <Cartridge Level>

Displays the amount of toner remaining in the toner cartridges. Other internal parts may reach the end of their lifetime before the toner runs out.

#### <Check Counter>

Displays the totals for printouts.  **Printing Reports and Lists(P. 455)**

#### <Version Information>



Displays firmware version information.

#### <Serial Number>

Displays the serial number of the machine.

**3 Status and logs of copied, printed, and sent/received documents**

Displays the current status of the selected item. You can check <TX Job>,<RX Job>, and <Fax Forwarding Errors> statuses only on a touch panel model. The <Copy/Print Job> screen is shown below as an example.

Copy/Print Job Status	
	Copy 10:00AM Copying
	Printer 10:03AM Paused
	Fax 10:05AM Paused

**4 <Network Information>**

Displays the network settings such as the IP address of the machine and status such as the condition of wireless LAN communications.  **Viewing Network Settings(P. 38)**

Network Information
IPv4
IPv6
Network Connection Method
Direct Connection Informati
IEEE 802.1X Error Informati

# Message Display

2KUU-02C

Messages are displayed on the screen in situations such as when paper runs out or when the expiration of the toner cartridge lifetime is reached. **Countermeasures for Each Message(P. 491)**

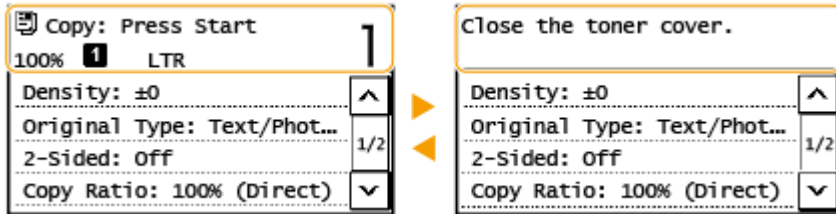

## NOTE

When <You have notifications.> or <Tap the [i] icon.> is displayed (Touch Panel Model)

- Tap to view the notification.

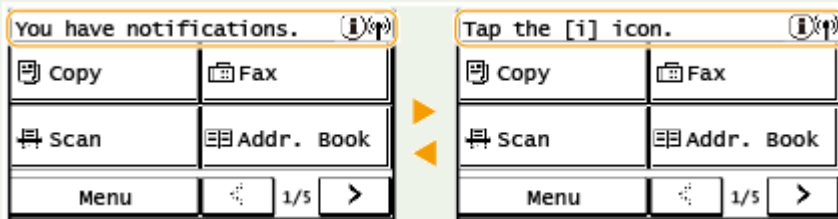

## When an Error Occurs

In some cases when an error occurs, instructions on how to respond to the error are displayed. Follow the on-screen instructions to solve the problem. The screen displayed when a paper jam occurs is shown below as an example.

### Touch Panel Model

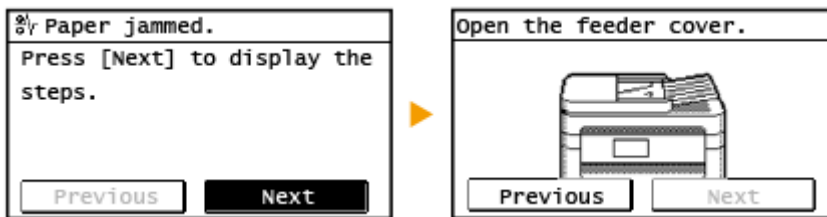

### 5 Lines LCD Model

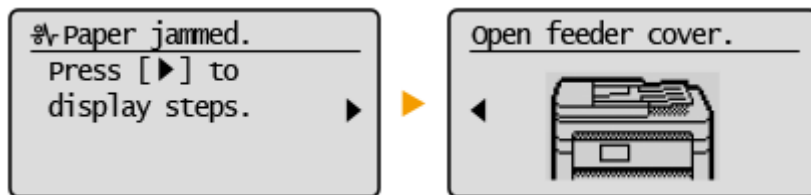

# Basic Operation

---

2KUU-02E

▶ **Basic Operation of Touch Panel Model(P. 118)**

▶ **Basic Operation of 5 Lines LCD Model(P. 120)**

## Basic Operation of Touch Panel Model

The display is a touch panel, allowing you to operate directly on the screen.

### IMPORTANT

#### Avoid the following actions.

- The display may malfunction or be damaged.
  - Pressing forcefully
  - Pressing with pointed objects (fingernails, ballpoint pen, pencil, etc.)
  - Operating with wet/soiled hands
  - Operating the display while an object is placed on it

### NOTE

- Before using the touch panel display, peel off the protective film from the display.

#### Tap

Touch the screen lightly and quickly. Use for selecting or finalizing items.

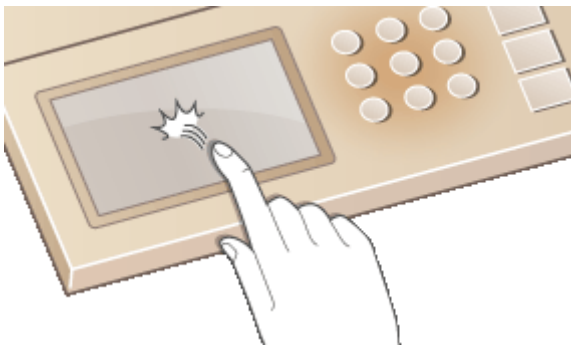

#### Long Touch

Keep finger held on the screen. When text cannot be completely displayed on one line ("..." appears), touch and hold the line to scroll all of the text. Also continuously increases/decreases the copy magnification.

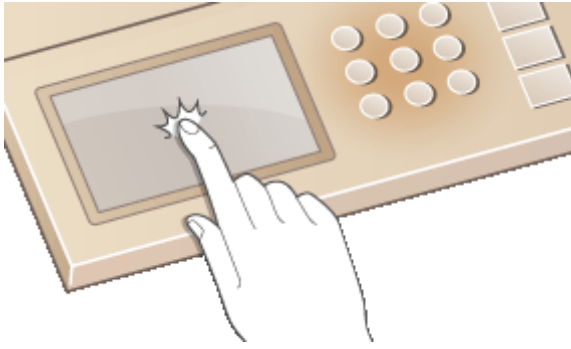

### ■ Selecting Items

Tap an item name or button to make a selection.

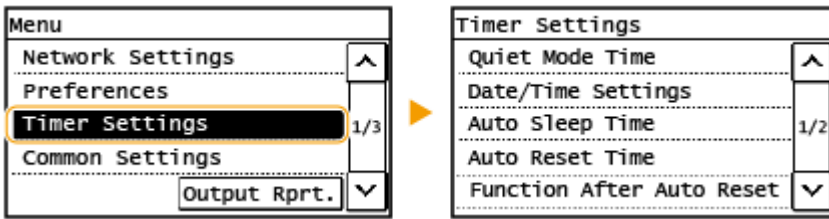

## NOTE

### If an item is mistakenly touched



- Slide your finger away then release it from the screen to cancel the selection.



### To return to the previous screen

- Press  to return to the previous screen.

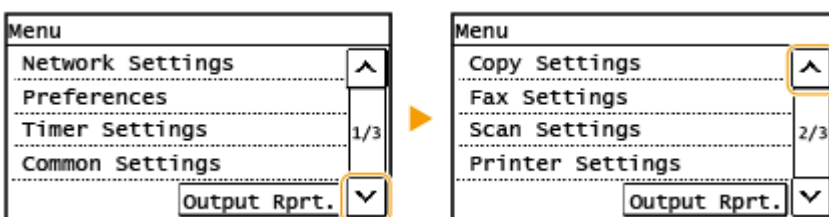

### ■ Scrolling the Screen

The scroll bar appears on the screen when there is still information that is undisplayed. If the scroll bar is displayed, tap <  > or <  > to scroll the screen. The screen changes page by page, and the page number is displayed in the scroll bar.



## ■ Changing Value and Setting

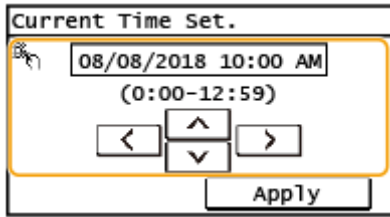

### Changing value

Tap <  > or <  > to enter values. If an icon such as below is displayed at the upper left of the screen, you can enter values directly using the numeric keys.



## NOTE

### To move the cursor



- When <  > or <  > is displayed, tap to move the cursor.

### Changing setting value

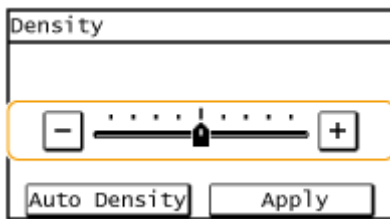
Tap <+> or <-> to adjust the setting on the scale.



## TIPS

- You can change a variety of display-related settings, such as the display language:  **<Display Settings>(P. 377)**
- You can change the screen that is automatically displayed when the machine remains idle for a specified length of time:  **<Function After Auto Reset>(P. 383)**
- You can change various settings about the operability such as screen brightness:  **<Display Settings>(P. 377)**

## Basic Operation of 5 Lines LCD Model

Use the keys shown below to specify settings and adjust values.

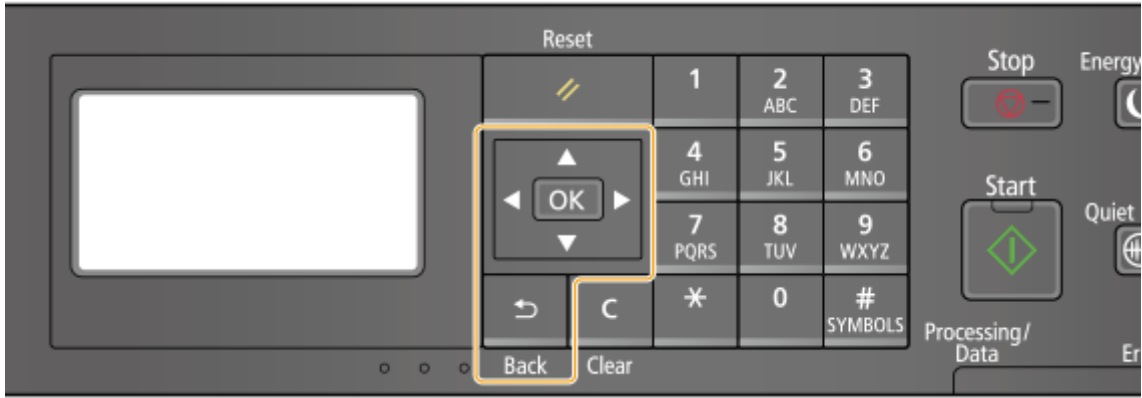

Using ▲ / ▼

■ Scrolling the screen

The scroll bar is displayed on the right side of the screen when not all of the information fits on one screen. If the scroll bar is displayed, use ▲ / ▼ to scroll up or down. The text and background colors of an item are inverted when it is selected.

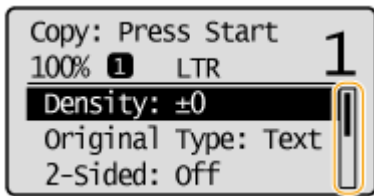

■ Changing a setting value

Use ▲ / ▼ to enter values. If an icon such as below is displayed at the upper left of the screen, you can enter values directly using the numeric keys. ▶ **Entering Text(P. 123)**

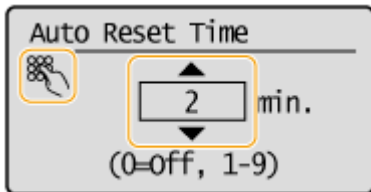

**NOTE:**

Values in ( ) displayed below the entry box are the enterable value range.

Using ◀ / ▶

■ Proceeding to next screen/Returning to previous screen

Press to ▶ proceed to the next screen. Press to ◀ return to the previous screen.

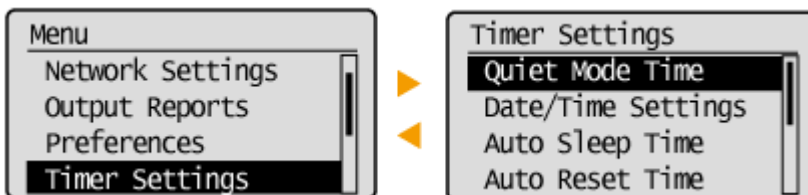

**NOTE:**

You can also proceed to the next screen by pressing **OK**, and return to the previous screen by pressing **Back**.



### ■ Changing Setting Values

Use ◀ / ▶ to adjust the slider scale.

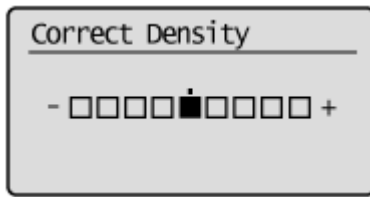

### ■ Moving the Cursor

Use ◀ / ▶ to enter text and values. ▶ **Entering Text(P. 123)**

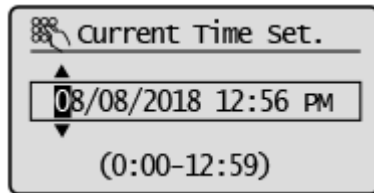

### Using **OK**

Press **OK** to apply a setting.

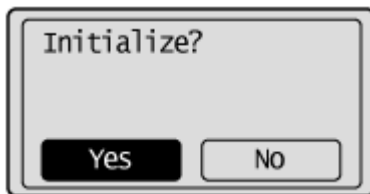

### Using the Numeric Keys

Use the numeric keys to enter text and values. ▶ **Entering Text(P. 123)**

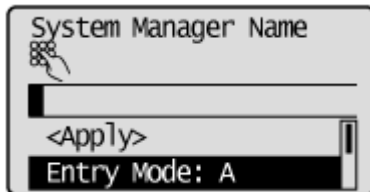

## TIPS

- You can change a variety of display-related settings, such as the scrolling speed or display language: ▶ **<Display Settings>(P. 377)**
- To change the screen that is automatically displayed when the machine remains idle for a specified length of time: ▶ **<Function After Auto Reset>(P. 383)**
- You can change various settings about the operability such as screen brightness: ▶ **<Display Settings>(P. 377)**

## Entering Text

- ▶ Entering Text on the Touch Panel Model(P. 123)
- ▶ Entering Text on the 5 Lines LCD Model(P. 125)

### Entering Text on the Touch Panel Model

Use the display and numeric keys to enter text and values.

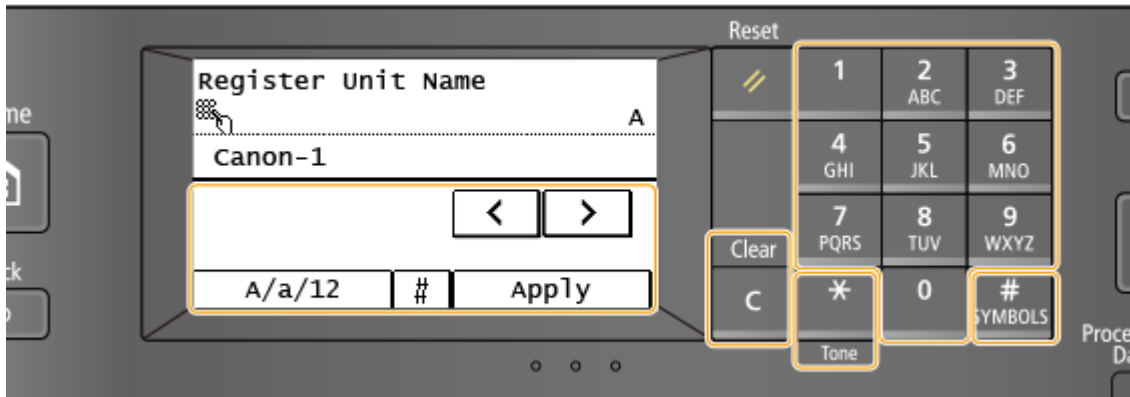

### Switching the Type of Character

Tap <A/a/12> to switch the type of character that is entered. The currently selected type of character is indicated by the "A", "a", or "12" displayed above and to the right of the text input field.

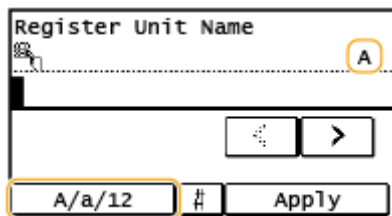









### NOTE

- You can also press **\*** to switch the type of character.

### Types of Character That Can Be Entered

Enter character with the numeric keys and the display. Character that can be entered is listed below.

Key	A	a	12
<b>1</b>	@ . - _ /		1
<b>2</b> ABC	ABC	abc	2









	DEF	def	3
	GHI	ghi	4
	JKL	jkl	5
	MNO	mno	6
	PQRS	pqrs	7
	TUV	tuv	8
	WXYZ	wxyz	9
	(Not available)		0
	(space) - . * # ! " , ; : ^ ` _ = /   ' ? \$ @ % & + \ ~ ( ) [ ] { } < >		(Not available)

## NOTE

- When the type of text that is entered is <A> or <a>, press  or tap <#> to display enterable symbols in the screen. Tap symbols to enter.

### Example of Entering Text and Numbers

**Example:** "Canon-1"

- Press <A/a/12> (or press ) repeatedly until <A> is selected.
- Press  repeatedly until the letter "C" is selected.
- Press <A/a/12> (or press ) repeatedly until <a> is selected.
- Press  repeatedly until the letter "a" is selected.
- Press  repeatedly until the letter "n" is selected.
- Press  repeatedly until the letter "o" is selected.
- Press  repeatedly until the letter "n" is selected.
- Press  repeatedly until the symbol "-" is selected.
- Press <A/a/12> (or press ) repeatedly until <12> is selected.

10 Press **1**.

11 Tap <Apply>.

### Deleting Text

One character is deleted each time **C** is pressed. Press and hold **C** to delete all of the entered text.

### Moving the Cursor (Entering a Space)

Tap < **<** > or < **>** > to move the cursor. To enter a space, move the cursor to the end of the text, and tap < **>** >.

## Entering Text on the 5 Lines LCD Model

Use the numeric keys to enter text and values.

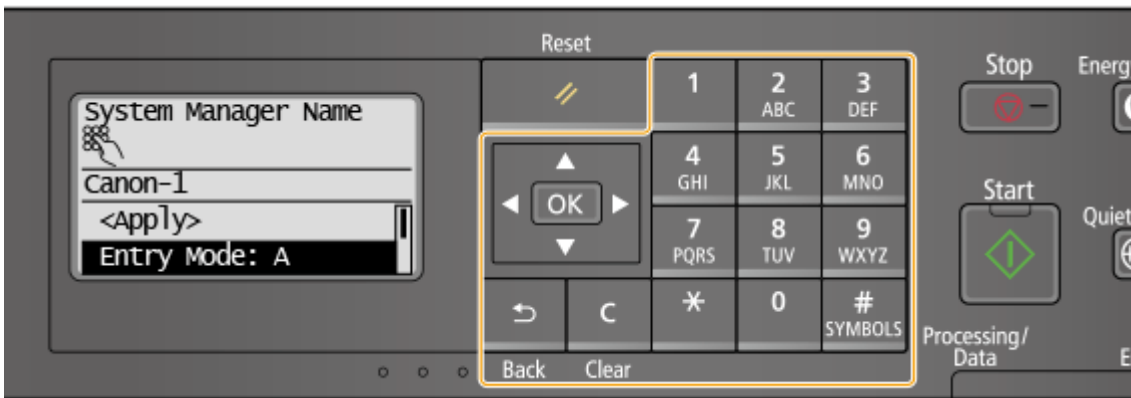

### Switching the Type of Character

Press **\*** to switch the type of character that is entered. The currently selected type of character is indicated by the "A", "a", or "12" of <Entry Mode>.

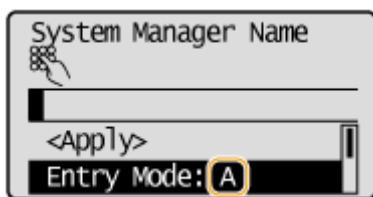

## NOTE











- You can also select <Entry Mode> and press **OK** to switch the type of character.

### Types of Character That Can Be Entered







Character that can be entered using the numeric keys and **#** are listed below.

Key	A	a	12
<b>1</b>	@ . - _ /		1



## Basic Operations

	ABC	abc	2
	DEF	def	3
	GHI	ghi	4
	JKL	jkl	5
	MNO	mno	6
	PQRS	pqrs	7
	TUV	tuv	8
	WXYZ	wxyz	9
	(Not available)		0
	(space) - . * # ! " , ; : ^ ` _ = /   ' ? \$ @ % & + \ ~ ( ) [ ] { } < >		(Not available)



### NOTE

- Press  or select <Symbol> and press  when the type of character that is entered is <A> or <a> to display a screen for selecting symbols. Use the  /  /  /  keys to select the symbol to enter, and press .

### Deleting Text



One character is deleted each time  is pressed. Press and hold  to delete all of the entered text.

### Moving the Cursor (Entering a Space)

Press  /  to move the cursor. To enter a space, move the cursor to the end of the text, and press .

### Example of Entering Text and Numbers

**Example:** "Canon-1"

- 1 Press  repeatedly until <A> is selected.
- 2 Press  repeatedly until the letter "C" is selected.
- 3 Press  repeatedly until <a> is selected.

- 4 Press **2** repeatedly until the letter "a" is selected.
- 5 Press **6** repeatedly until the letter "n" is selected.
- 6 Press **6** repeatedly until the letter "o" is selected.
- 7 Press **6** repeatedly until the letter "n" is selected.
- 8 Press **1** repeatedly until the symbol "-" is selected.
- 9 Press **\*** repeatedly until <12> is selected.
- 10 Press **1**.
- 11 Select <Apply>, and press **OK**.

## Placing Originals

2KUU-02H

Place originals on the platen glass or in the feeder. Use the platen glass when scanning thick or bound documents such as books. You can load two or more sheets of originals in the feeder so that they can be scanned continuously. For information on loadable sizes, etc., see [▶Main Unit\(P. 533\)](#) or [▶Feeder\(P. 536\)](#) .



[▶Placing Originals on the Platen Glass\(P. 129\)](#)

[▶Placing Originals in the Feeder\(P. 129\)](#)

### IMPORTANT

#### Use originals that are completely dry

- When placing originals, make sure that any glue, ink, or correction fluid on the originals has completely dried.

#### To avoid paper jams

- Do not place the following types of originals in the feeder as this may cause paper jams:
  - Wrinkled or creased paper
  - Carbon paper
  - Curled or rolled paper
  - Coated paper
  - Torn paper
  - Onion skin or thin paper
  - Stapled or clipped originals
  - Paper printed by a thermal transfer printer
  - Transparencies



### NOTE

#### To scan originals more accurately

- Originals placed in the feeder are scanned while being fed into the machine. On the other hand, originals placed on the platen glass remain in a fixed position while they are scanned. To ensure more accurate scanning results, placing originals on the platen glass is recommended.

#### To scan tracing paper or transparencies

- To scan transparent originals (for example, tracing paper or transparencies), place them on the platen glass.

## Placing Originals on the Platen Glass

### 1 Open the feeder.

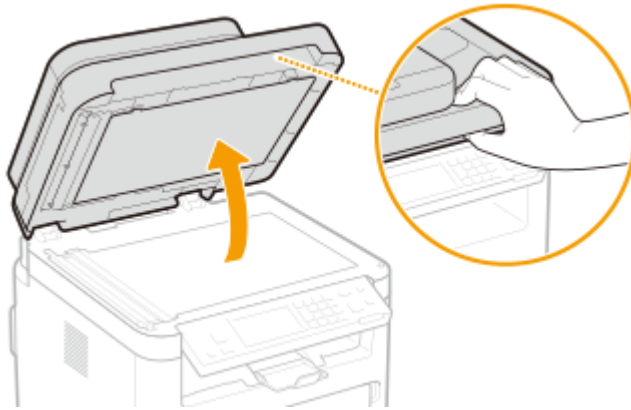

### 2 Place the original face down on the platen glass.

- Align the corner of the original with the top-left corner of the platen glass.

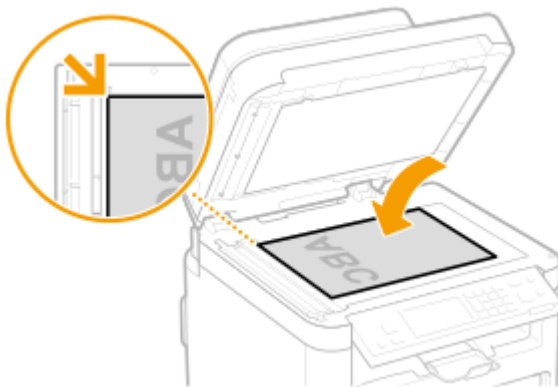

#### NOTE:

- To scan transparent originals (for example, tracing paper or transparencies), cover them with plain white paper.

### 3 Gently close the feeder.

⇒ The machine is ready to scan the original.

#### NOTE:

**When scanning is complete**

- Remove the original from the platen glass.

## Placing Originals in the Feeder

### 1 Open the original supply tray.



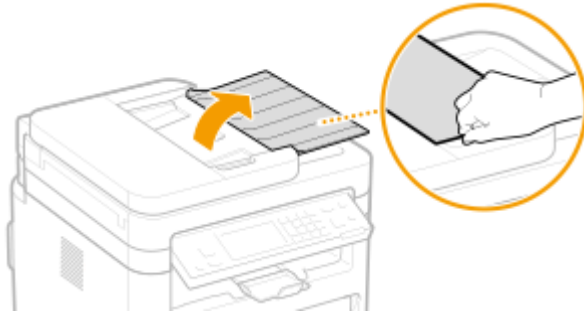

## 2 Spread the slide guides apart.

- Slide the slide guides outward until they are slightly farther apart than the actual original width.

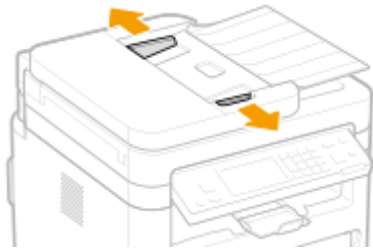

## 3 Fan the original stack and align the edges.

- Fan the original stack in small batches, and align the edges by lightly tapping the stack on a flat surface a few times.



## 4 Place the original(s) face up in the feeder.

- Make sure that the original stack does not exceed the load limit line (a).

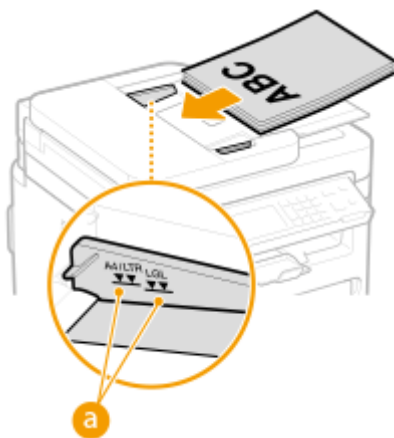

### IMPORTANT:

- Do not load originals of various sizes at the same time.
- If originals are loaded so that they exceed the load limit line, scanning may stop or a paper jam may occur.

## 5 Align the slide guides against the edges of the original.

- Slide the slide guides inward until they are aligned securely against the edges of the original.

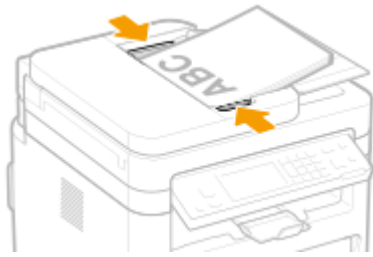

⇒ The machine is ready to scan the original.

### **IMPORTANT:**

#### **Align the slide guides securely against the edges of the original**

- Slide guides that are too loose or too tight can cause misfeeds or paper jam.

#### **While originals are being scanned**

- Do not add or remove originals.

#### **When scanning is complete**

- Remove the scanned originals from beneath the feeder to prevent paper jams.

# Loading Paper

2KUU-02J

You can load the paper into the drawer. See [▶Available Paper\(P. 538\)](#) for available paper sizes and types.

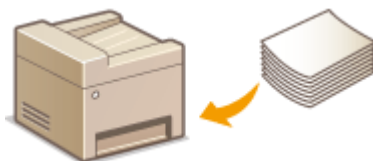

## About Paper

- ▶ [Precautions for Paper\(P. 132\)](#)
- ▶ [Storing the Paper Printed with the Machine\(P. 133\)](#)

## How to Load Paper

- ▶ [Loading Paper in the Drawer\(P. 134\)](#)
- ▶ [Loading Paper in the Multi-Purpose Tray\(P. 138\)](#)
- ▶ [Loading Envelopes\(P. 141\)](#)
- ▶ [Loading Preprinted Paper\(P. 143\)](#)

## Configuring the Settings for the Loaded Paper

- ▶ [Specifying Paper Size and Type\(P. 145\)](#)

## Precautions for Paper

### IMPORTANT

#### Do not use the following types of paper:

- A paper jam or printing error may occur.
  - Wrinkled or creased paper
  - Curled or rolled paper
  - Torn paper
  - Damp paper
  - Very thin paper
  - Thin coarse paper
  - Paper printed by a thermal transfer printer
  - Back side of paper printed by a thermal transfer printer
  - Highly textured paper
  - Glossy paper

#### Notes on use of paper

- Only use paper that has fully acclimatized to the environment in which the machine is installed. Using paper that has been stored under different temperature or humidity conditions may cause paper jams or result in poor print quality.

### Paper handling and storage

- It is recommended that you use paper as soon as possible after unwrapping. Paper remaining unused should be covered with the original wrapping paper and stored on a flat surface.
- Keep the paper wrapped in its original package to protect the paper from moisture or dryness.
- Do not store the paper in such a way that may cause it to curl or fold.
- Do not store the paper vertically or do not stack too much paper.
- Do not store the paper in direct sunlight, or in a place subject to high humidity, dryness, or drastic changes in temperature or humidity.

## NOTE

### When printing on paper that has absorbed moisture

- Steam may emit from the paper output area, or water droplets may form around the paper output area. There is nothing unusual about any of these occurrences, which occur when the heat generated from fixing toner on the paper causes moisture in the paper to evaporate (most likely to occur at low room temperatures).

## Storing the Paper Printed with the Machine

When handling/storing the paper printed with the machine, take the following precautions.

### ■ How to Store the Printed Paper

- Store on a flat surface.
- Do not store together with articles made of PVC (polyvinyl chloride) such as clear folders. Toner may melt, resulting in the paper's sticking to PVC articles.
- Take care that the paper does not get folded or creased. Toner may peel off.
- To store over a long period of time (two years or longer), store in binders or equivalent.
- When the paper is stored over a long period of time, it may become discolored and thus the print may seem to have undergone a change of color.
- Do not store in a place where the temperature is high.

### ■ Precautions When Applying Adhesive

- Always use insoluble adhesive.
- Before applying adhesive, perform a test using a printout no longer required.
- When putting adhesive-applied paper sheets one over another, make sure that the adhesive is completely dried out.

## LINKS

---

- [Registering a Custom Paper Size\(P. 148\)](#)

## Loading Paper in the Drawer

2KUU-02K

Load the paper that you usually use in the drawer. When you want to print on paper that is not loaded in the drawer, load the paper in the multi-purpose tray. [▶Loading Paper in the Multi-Purpose Tray\(P. 138\)](#)

### NOTE

#### When loading A5 size paper

- When setting the paper size, make sure the current paper orientation. When loading paper in landscape orientation, you must configure this setting in the printer driver. For more information, refer to the printer driver Help.

Landscape orientation



Portrait orientation



### 1 Open the front cover.

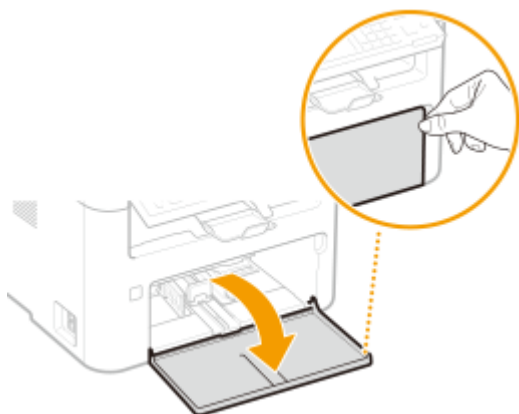

### 2 Spread the paper guides apart.

- Slide the paper guides outward.



### 3 Load the paper and slide it all the way in, until it touches the back side.

- Load the paper in portrait orientation (with the short edge toward the machine) and the print side face up. Paper cannot be loaded in landscape orientation.
- Before loading it, fan the paper stack well, and tap it on a flat surface to align the edges.
- When you insert the paper with <Notify to Check Paper Settings> set to <On>, a confirmation screen is displayed. ▶<Notify to Check Paper Settings>(P. 378)

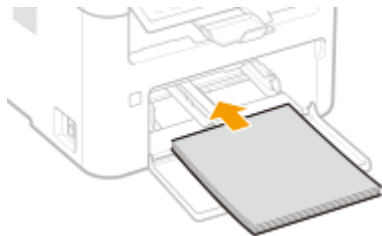

### IMPORTANT:

#### Keep the paper stack within the load limit guides

Make sure that the paper stack does not exceed the load limit guides (a). Loading too much paper may cause paper jams.

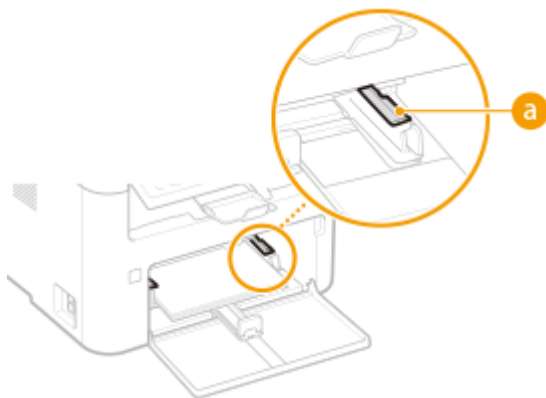

### NOTE:

When loading envelopes or preprinted paper, see ▶<Loading Envelopes>(P. 141) or ▶<Loading Preprinted Paper>(P. 143) .

### 4 Align the paper guides against the edges of the paper.

- Align the paper guides securely against the edges of the paper.

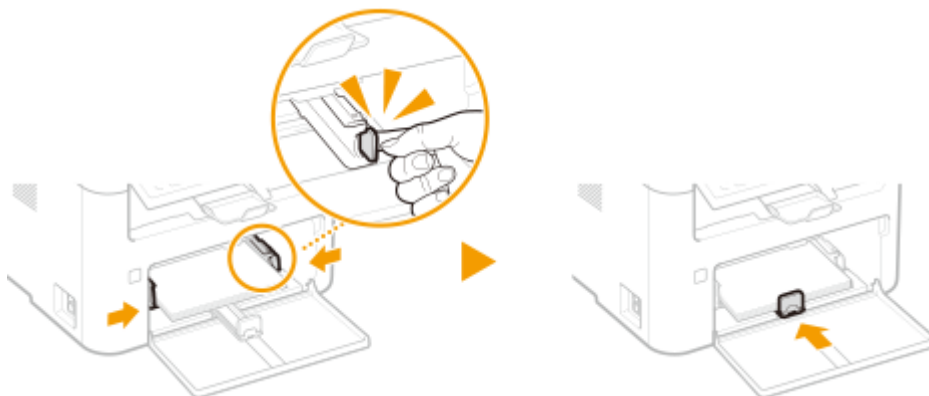
**IMPORTANT:**

**Align the paper guides securely against the paper**

Paper guides that are too loose or too tight may cause misfeeds or paper jams.

**5 Close the front cover.****NOTE**

- When performing printing, open the paper stopper in advance so that the output paper does not fall out of the output tray.

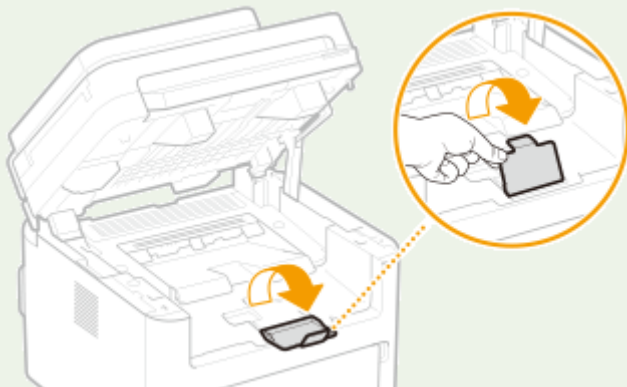

» Continue to **Specifying Paper Size and Type in the Drawer(P. 146)**

**IMPORTANT:**

**When changing the paper size or type**

- The factory default settings for paper size and type are <LTR> and <Plain>, respectively. If you load a different size or type of paper into the machine, make sure to change the settings. If you do not change the settings, the machine cannot print properly.

**Printing on the Back Side of Printed Paper (Manual 2-Sided Printing)**

- You can print on the back side of printed paper. Flatten any curls on the printed paper and insert it into the drawer or multi-purpose tray ( [▶ Loading Paper in the Multi-Purpose Tray\(P. 138\)](#) ), with the side to print face up (previously printed side face down).
  - When using the multi-purpose tray, load one sheet of paper each time you print.
  - You can use only the paper printed with this machine.
  - You cannot print on the side that has previously been printed on.
  - If you are using A5 size paper, the reverse side may not be printed correctly.

## LINKS

---

[▶ Available Paper\(P. 538\)](#)



## Loading Paper in the Multi-Purpose Tray

2KUU-02L

When you want to print on paper that is not loaded in the drawer, load the paper in the multi-purpose tray. Load the paper that you usually use in the drawer. **▶ Loading Paper in the Drawer (P. 134)**

### IMPORTANT

#### Load only one sheet of paper at a time

- Only one sheet of paper can be loaded each time you print.

### NOTE

#### When loading A5 size paper

- When setting the paper size, make sure the current paper orientation. When loading paper in landscape orientation, you must configure this setting in the printer driver. For more information, refer to the printer driver Help.

Landscape orientation



Portrait orientation



#### 1 Open the front cover.

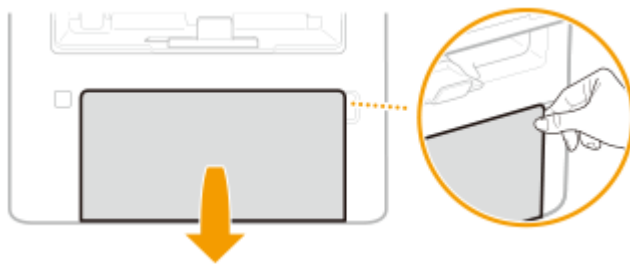

#### 2 Lower the multi-purpose tray.

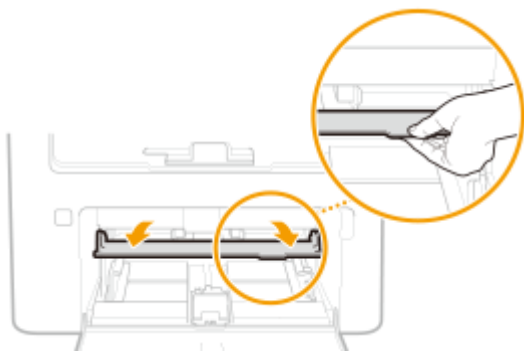

### 3 Spread the paper guides apart.

- Slide the paper guides outward.

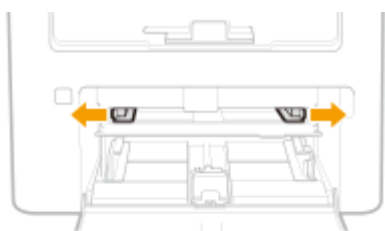

### 4 Insert the paper slowly into the multi-purpose tray until it reaches the back of the tray.

- Load the paper with the print side face up.

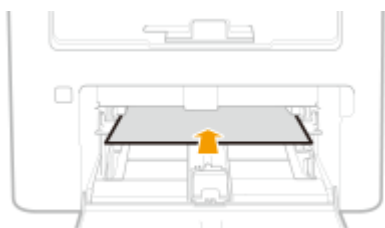

#### NOTE:

- When loading envelopes or paper with a logo, see [▶ Loading Envelopes \(P. 141\)](#) or [▶ Loading Preprinted Paper \(P. 143\)](#).

### 5 Align the paper guides against the edges of the paper.

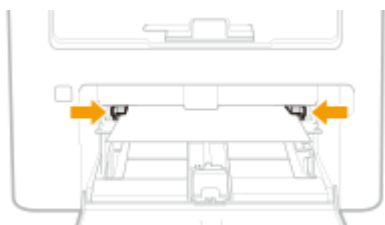

#### IMPORTANT:

**Align the paper guides securely against the edges of the paper**

- Paper guides that are too loose or too tight can cause misfeeds or paper jams.

## 6 Close the front cover.

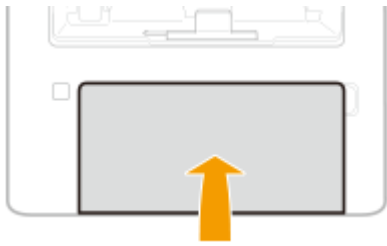

» Continue to [▶Specifying Paper Size and Type in the Multi-Purpose Tray\(P. 147\)](#)

### Printing on the Back Side of Printed Paper (Manual 2-Sided Printing)

- You can print on the back side of printed paper. Flatten any curls on the printed paper and insert it into the drawer ( [▶Loading Paper in the Drawer\(P. 134\)](#) ) or multi-purpose tray, with the side to print face up (previously printed side face down).
  - You can use only the paper printed with this machine.
  - You cannot print on the side that has previously been printed on.
  - If you are using A5 size paper, the reverse side may not be printed correctly.

### LINKS

---

[▶Available Paper\(P. 538\)](#)

# Loading Envelopes

2KUU-02R

Make sure to flatten any curls on envelopes before loading them. Also pay attention to the orientation of envelopes and which side is face up.

- ▶ **Before Loading Envelopes(P. 141)**
- ▶ **Loading Envelopes in the Drawer(P. 142)**
- ▶ **Loading Envelopes in the Multi-Purpose Tray(P. 142)**

## NOTE

- This section describes how to load envelopes in the orientation you want, as well as procedures that you need to complete before loading envelopes. For a description of the general procedure for loading envelopes in the drawer, see ▶ **Loading Paper in the Drawer(P. 134)** or ▶ **Loading Paper in the Multi-Purpose Tray(P. 138)** .

## Before Loading Envelopes

Follow the procedure below to prepare the envelopes before loading.

- 1 Close the flap of each envelope.**



- 2 Flatten them to release any remaining air, and make sure that the edges are pressed tightly.**



- 3 Loosen any stiff corners of the envelopes and flatten any curls.**

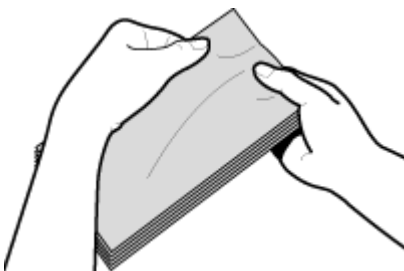

#### 4 Align the edges of the envelopes on a flat surface.

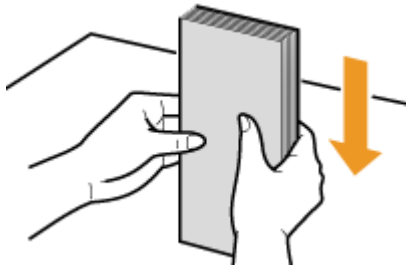

### Loading Envelopes in the Drawer

Load the envelopes Monarch, No. 10 (COM10), DL, or C5 in portrait orientation (with the short edge toward the machine), with the non-glued side (front side) face up. You cannot print on the reverse side of envelopes.

#### NOTE

- Load the envelopes so that the edge with the flap is toward the left side as shown in the illustration.

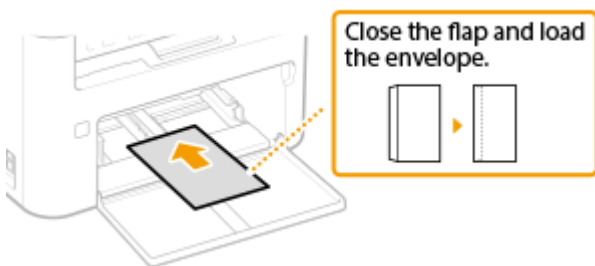

### Loading Envelopes in the Multi-Purpose Tray

Load the envelopes Monarch, No. 10 (COM10), DL, or C5 in portrait orientation (with the short edge toward the machine), with the non-glued side (front side) face up. You cannot print on the reverse side of envelopes.

#### NOTE

- Load the envelopes so that the edge with the flap is toward the left side as shown in the illustration.

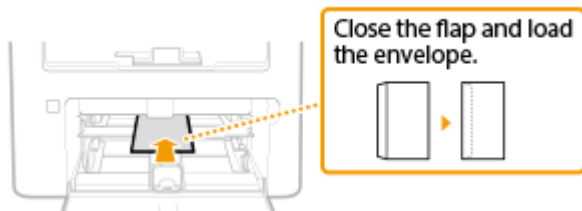

## Loading Preprinted Paper

When you use paper that has been preprinted with a logo, pay attention to the orientation of the paper when loading. Load the paper properly so that printing is performed on the correct side of the paper with a logo.



▶ **Making Printouts on Paper with Logos(P. 143)**

▶ **Making 2-Sided Printouts on Paper with Logos(P. 143)**

### NOTE

- This section mainly describes how to load preprinted paper with the proper facing and orientation. For a description of the general procedure for loading paper in the drawer, see ▶ **Loading Paper in the Drawer(P. 134)** or ▶ **Loading Paper in the Multi-Purpose Tray(P. 138)** .

### Making Printouts on Paper with Logos

Load the paper with the logo side (the side to print the document) face up.

#### Printing on Paper with Logos in Portrait Orientation

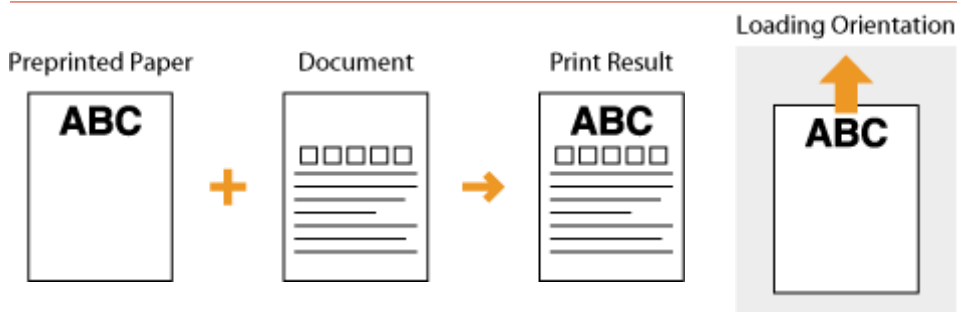

#### Printing on Paper with Logos in Landscape Orientation

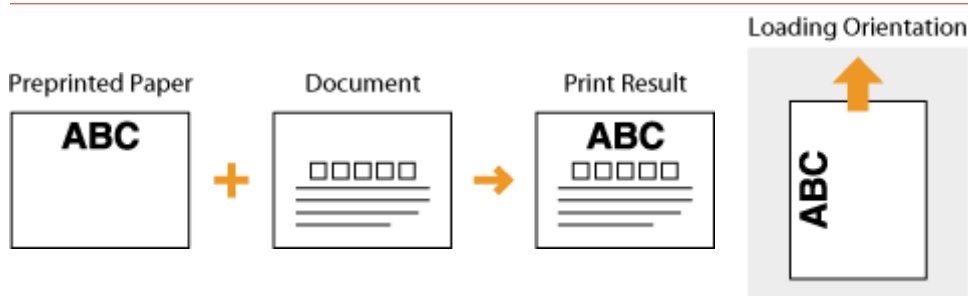

### Making 2-Sided Printouts on Paper with Logos

Load the paper with the front logo side (the side to print the first page of the document) face down.

**Printing on Paper with Logos in Portrait Orientation**

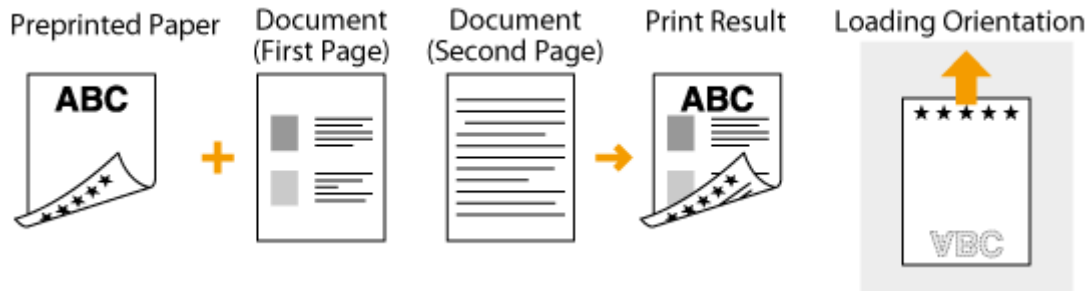

**Printing on Paper with Logos in Landscape Orientation**

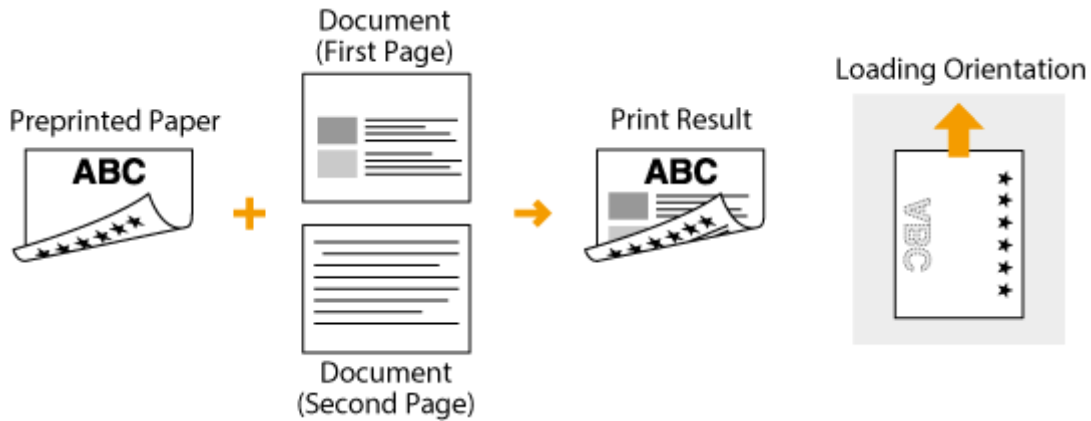

**NOTE**

**The <Switch Paper Feed Method> setting**

- When you print on preprinted paper, you need to change the facing of the paper to load each time you perform 1-sided and 2-sided printing. However, if <Switch Paper Feed Method> is set to <Speed Priority>, the facing that you use for loading preprinted paper for 2-sided printing (logo side face down) can also be used for 1-sided printing. This setting is especially useful if you frequently perform both 1-sided and 2-sided printing. **<Switch Paper Feed Method> (P. 385)**

## Specifying Paper Size and Type

---

2KUU-02U

Set the paper size and paper type when printing from an application with which you cannot set the paper size and paper type. Make sure to change the paper settings when you load the paper that is different from the previously loaded paper.

- ▶ **Specifying Paper Size and Type in the Drawer(P. 146)**
- ▶ **Specifying Paper Size and Type in the Multi-Purpose Tray(P. 147)**
- ▶ **Registering a Custom Paper Size(P. 148)**
- ▶ **Limiting the Paper Sizes Displayed(P. 150)**

### IMPORTANT

- If the setting does not match the size and type of loaded paper, a paper jam or printing error may occur.



# Specifying Paper Size and Type in the Drawer

2KUU-02W

## 1 Display the <Paper Settings> screen. [▶Home Screen\(P. 111\)](#)

### Touch Panel Model

Select <Paper Set.> in the Home screen.

### 5 Lines LCD Model

Press  (Paper Setting).

## 2 Select <Drawer 1>.

## 3 Select the paper size.

- If the loaded paper size is not displayed, select <Other Sizes>.

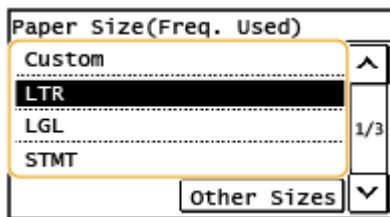

## 4 Select the paper type.

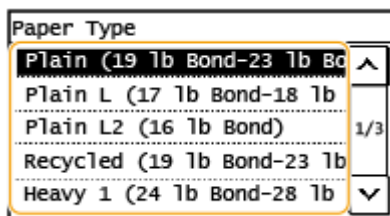

## LINKS

- ▶ [Loading Paper in the Drawer\(P. 134\)](#)
- ▶ [Limiting the Paper Sizes Displayed\(P. 150\)](#)
- ▶ [Available Paper\(P. 538\)](#)

# Specifying Paper Size and Type in the Multi-Purpose Tray

2KUU-02X

## 1 Display the <Paper Settings> screen. ▶ Home Screen(P. 111)

### Touch Panel Model

Select <Paper Set.> in the Home screen.

### 5 Lines LCD Model

Press  (Paper Setting).

## 2 Select <MP Tray>.

## 3 Select the paper size.

- If the loaded paper size is not displayed, select <Other Sizes>.

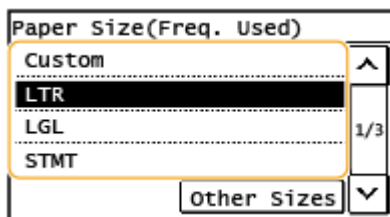

## 4 Select the paper type.

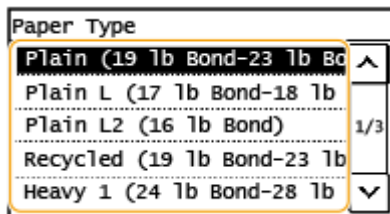

## LINKS

- ▶ Loading Paper in the Multi-Purpose Tray(P. 138)
- ▶ Limiting the Paper Sizes Displayed(P. 150)
- ▶ Available Paper(P. 538)

# Registering a Custom Paper Size

2KUU-02Y

You can register one frequently used custom paper size.

## 1 Display the <Paper Settings> screen. Home Screen(P. 111)

### Touch Panel Model

















Select <Paper Set.> in the Home screen.

### 5 Lines LCD Model

Press  (Paper Setting).

## 2 Select <MP Tray> or <Drawer 1> <Custom>.

## 3 Specify the length of the <X> side and <Y> side.

- Execute the following steps in sequence: <X>  enter the length of the <X> side using  < (  ) / <  > (  ), with <  > (  ) / <  > (  ) to move the cursor between the digits for inputting whole numbers and fractions  <Apply> (  )  <Y>  enter the length of the <Y> side  <Apply> (  )  <Apply>

### Touch Panel Model

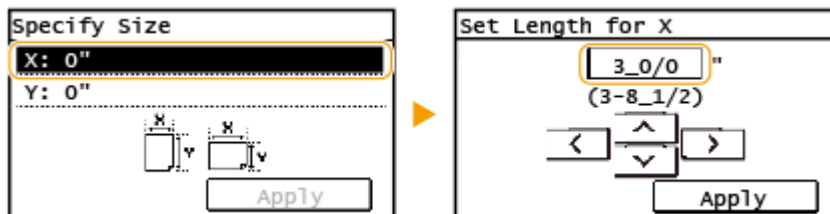

### 5 Lines LCD Model



## 4 Select <Apply>.

## 5 Select the paper type.

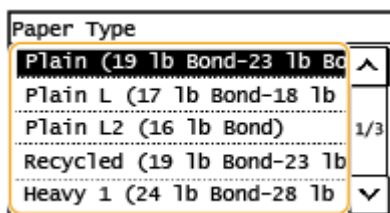

## LINKS

---

- ▶ **Loading Paper in the Drawer(P. 134)**
- ▶ **Loading Paper in the Multi-Purpose Tray(P. 138)**

# Limiting the Paper Sizes Displayed

2KUU-030

You can ensure that only frequently used paper sizes are shown in the screen for selecting the paper size setting.

## 1 Display the <Paper Settings> screen. Home Screen(P. 111)

### Touch Panel Model

Select <Paper Set.> in the Home screen.

### 5 Lines LCD Model

Press  (Paper Setting).

## 2 Select <Select Frequently Used Paper Sizes>.

## 3 Select <Multi-Purpose Tray> or <Drawer 1>.

## 4 Clear the check boxes for paper sizes you do not want displayed.

- Ensure that only the check boxes for frequently used paper sizes are selected.

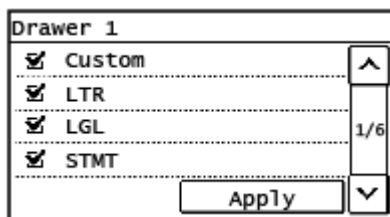



### NOTE:

- Paper sizes that are not selected can be viewed by selecting the <Other Sizes> in the paper size setting selection screen.

## 5 Select <Apply>.

### LINKS

-  Specifying Paper Size and Type in the Drawer(P. 146)
-  Specifying Paper Size and Type in the Multi-Purpose Tray(P. 147)

## Customizing the Display

---

2KUU-031

In order to make the Home screen easier to use, you can customize it.



### Customizing the Home Screen

---

You can rearrange buttons that are displayed in the Home screen. [▶ Customizing the Home Screen\(P. 152\)](#)

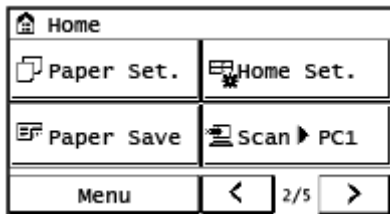

# Customizing the Home Screen

2KUU-032

You can change the item display order to make it easier to access the Home screen, and customize the Home screen.

## ■ Changing the Arrangement of Buttons

### 1 Select <Home Set.> in the Home screen. ▶ Home Screen(P. 111)

- If a screen appears prompting you to enter a PIN, enter the correct PIN using the numeric keys, and tap <Apply>. ▶ Setting the System Manager PIN(P. 293)

### 2 Select <Set Display Order>.

### 3 Select the button to move.

### 4 Select <Previous> or <Next> to move the button, and select <Apply>.

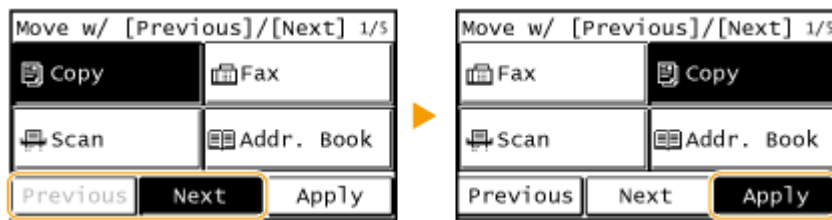

- The button moves as many times as you tapped.
- A long touch on <Previous> or <Next> moves the selected button continuously.

### 5 Repeat steps 3 and 4 to move all buttons you want to move.

### 6 Select <End>.

## ■ Inserting a Blank

### 1 Select <Home Set.> in the Home screen. ▶ Home Screen(P. 111)

- If a screen appears prompting you to enter a PIN, enter the correct PIN using the numeric keys, and select <Apply>. ▶ Setting the System Manager PIN(P. 293)

### 2 Select <Insert and Delete Blank>.

**3 Select the button where you want to insert a blank, and select <Insert>.**

- To delete an inserted blank, select the blank, select <Delete>, and proceed to step 5.

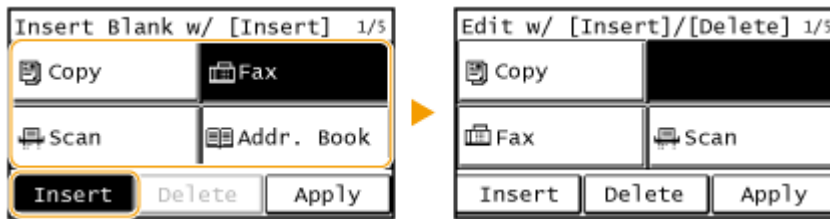
**4 Select <Apply>.****5 Select <End>.**

## LINKS

- [Basic Operation\(P. 118\)](#)





## Changing the Default Settings for Functions

2KUU-0AE

The default settings are the settings that are displayed whenever you turn ON the machine, or when you press . If you change these default settings to match the operations that you perform frequently, you can eliminate the need to specify the same settings every time you perform an action.

### ■ Copy

For information about changeable setting items, see  **<Change Default Settings>(P. 387)** .



<Menu> () ▶ <Copy Settings> ▶ <Change Default Settings> ▶ Select the setting ▶ Change the default value of the selected item ▶ <Apply>

### ■ FAX

For information about changeable setting items, see  **<Fax Settings>(P. 389)** .



<Menu> ▶ <Fax Settings> ▶ <TX Function Settings> ▶ <Change Default Settings> ▶ Select the setting ▶ Change the default value of the selected item ▶ <Apply>

### ■ E-Mail

For information about changeable setting items, see  **<E-Mail Settings>(P. 400)** .



<Menu> ▶ <Scan Settings> ▶ <E-Mail Settings> ▶ <Change Default Settings> ▶ Select the setting ▶ Change the default value of the selected item ▶ <Apply>

### ■ Shared Folder

For information about changeable setting items, see  **<File Settings>(P. 401)** .



<Menu> ▶ <Scan Settings> ▶ <File Settings> ▶ <Change Default Settings> ▶ Select the setting ▶ Change the default value of the selected item ▶ <Apply>

## NOTE

- If you select <Initialize Default Settings> on each setting screen, you can restore the default settings.

# Setting Sounds

2KUU-034

The machine produces sounds in a variety of situations, such as when fax sending is complete or when a paper jam or error occurs. You can set the volume of each of these sounds individually.

**1** Select <Menu> in the Home screen. ▶ Home Screen(P. 111)

**2** Select <Preferences> ▶ <Volume Settings>.

**3** Select a setting.

Setting	Description	Action
<Fax Tone>	Sound produced during a fax transmission	Go to step 4.
<Ring Tone>	Sound produced when an incoming fax is received	
<TX Done Tone>	Sound produced when fax sending is complete	
<RX Done Tone>	Sound produced when fax receiving is complete	
<Scanning Done Tone>	Sound produced when fax original scanning is complete	
<Entry Tone>	Confirmation sound each time a key on the operation panel or button on the display is pressed	Select <On> (produce a tone) or <Off> (not produce a tone).
<Invalid Entry Tone>	Sound produced when an invalid key operation is performed, such as when you enter a number outside the valid setting range	
<Warning Tone>	Sound produced when a paper jam or other error occurs	
<Job Done Tone>	Sound produced when an operation such as copying or scanning is complete	
<Energy Saver Alert>	Sound produced when the machine enters or exits sleep mode	
<Original in Feeder Detection Tone>	Sound produced when an original is loaded in the feeder	

**4** Adjust the volume, and select <Apply>.

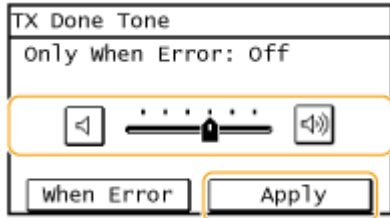

- To mute the sound, move the cursor all the way to the left.



■ **End sound only for error**

Select <When Error>, select <On>, and select <Apply>.

## Entering Quiet Mode

2KUU-033

The quiet mode function reduces the operation sound of the machine. For example, when using the machine at night, press  on the operation panel. With only this operation, you can easily minimize operation sound. You can also specify a time for the machine to automatically enter quiet mode.

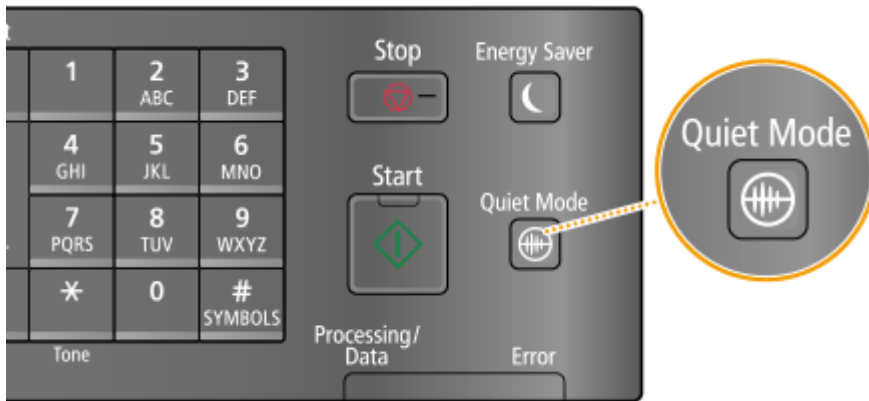

### NOTE

#### When in quiet mode

- When the machine enters quiet mode,  lights up green.

#### When quiet mode is enabled

- The operation of functions becomes slower.
- On the touch panel model, the volume of notifications such as <Entry Tone> and <Job Done Tone> is not lower. To adjust volume or mute sounds, see [▶Setting Sounds\(P. 155\)](#) .

#### When the machine cannot enter quiet mode

- The machine is in Special Printing Mode
- A particular paper size or paper type is specified

### Specifying a time for the machine to enter quiet mode

You can specify a time for the machine to enter or exit quiet mode automatically. For example, this is useful when wanting to reduce operation noise only for late-night operation.

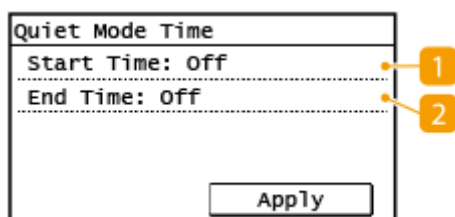

**1 <Start Time>**

Specify a time for entering quiet mode. To set, select <On> then specify the time.

**2 <End Time>**

Specify a time for exiting quiet mode. To set, select <On> then specify the time.

**Exiting Quiet Mode**

---

Press  to exit quiet mode.

## Entering Sleep Mode

2KUU-035

The sleep mode function reduces the amount of power consumed by the machine by disabling power flow to the operation panel. If no operations will be performed on the machine for a while, such as during a lunch break, you can save power simply by pressing  on the operation panel.

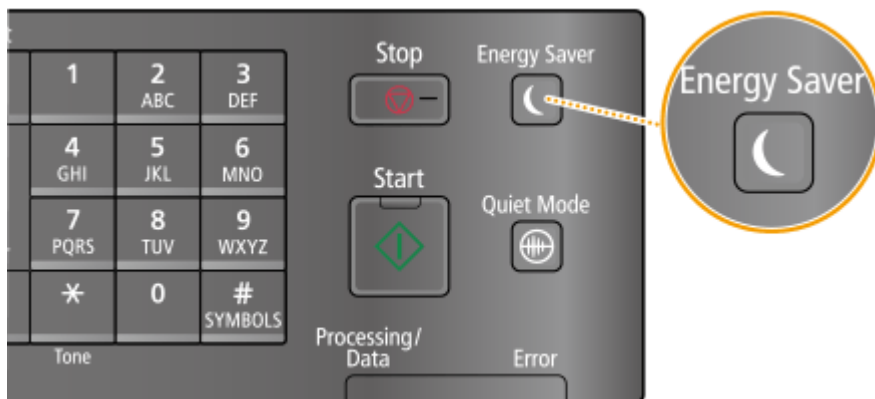

### NOTE

#### When in sleep mode

- When the machine enters sleep mode,  lights up green.



#### Situations in which the machine does not enter sleep mode

- When the machine is in operation
- When the [Processing/Data] indicator is lit up or blinking
- When originals are placed in the feeder
- When the machine is performing an operation such as adjustment or cleaning
- When the machine is removing condensation
- When a paper jam occurs
- When the receiver of the external telephone is off the hook
- When the machine is set such that the fax incoming ring will not sound
- When the menu screen is displayed
- When an error message is displayed on the screen (There are some exceptions. The machine sometimes enters sleep mode when an error message is displayed.)
- When the machine is waiting for a wireless LAN connection or Direct Connection

#### Changing the Auto Sleep Time Value

Auto Sleep Time is a function that automatically puts the machine into the sleep mode if it remains idle for a specified length of time. We recommend using the factory default settings (  **<Timer Settings>(P. 381)** ) to reduce power usage. If you want to change the amount of time that elapses before the machine enters the auto sleep mode, perform the procedure below.



<Menu> (  ) ▶ <Timer Settings> ▶ <Auto Sleep Time> ▶ Set the amount of time that elapses before the machine automatically enters sleep mode ▶ <Apply> (  )

### Exiting Sleep Mode

---

You can press  or any other key on the operation panel to exit the sleep mode.

### NOTE

- On the touch panel model, you can also tap the display to exit sleep mode.
- If an external telephone is connected, the machine exits sleep mode when you take the receiver off the hook.

## Registering Destinations

2KUU-036



You can register frequently used fax/scan destinations in the Address Book and easily select them when needed ( ▶ **Registering Destinations in the Address Book(P. 163)** ). Destinations can be searched alphabetically, from lists in the Address Book, or by entering three-digit numbers (coded dial numbers). You can also specify destinations more quickly by using the following features.

### ■ One-Touch Dial

Registering a lot of addresses in the Address Book makes it difficult to find the destination you need. To avoid this situation, register frequently used destinations as One-Touch Dial numbers. This allows them to be displayed by the One-Touch buttons in the Home screen. You can register up to 4 destinations for One-Touch Dial. ▶ **Registering Destinations for One-Touch Dial(P. 165)**

### ■ Group Dial

You can select multiple destinations that have already been registered and register them together as a group. You can send faxes or e-mails to multiple destinations at the same time. Groups can also be registered in One-Touch Dial. ▶ **Registering Multiple Destinations as a Group(P. 167)**

### ■ Index

The registered destinations are classified into indexes depending on the initial character or the type of address. Changing indexes allows you to perform a destination search quickly. Tap < ◀ > or < ▶ > the target index sideways to change the display.

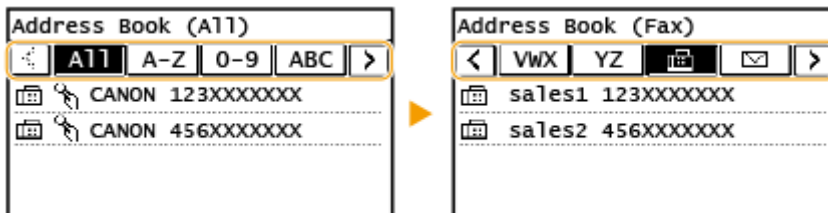

#### <All>

Displays all the destinations registered in the Address Book.

#### <A-Z>, <0-9> or <ABC> to <YZ>

Displays destinations with recipient names whose first characters correspond to the characters of the selected index.

#### < 📠 >

Displays destinations for faxes.

#### < ✉ >

Displays destinations for e-mails.

#### < 📁 >

Displays destinations for shared folders. Registration of destinations is performed from the computer.

▶ **Setting a Shared Folder as a Save Location(P. 86)**

▶ **Registering Destinations from Remote UI(P. 347)**





Displays a list of destinations registered in Group Dial.



Only destinations for one-touch dialing are displayed.

## NOTE

- Use the computer to register a shared folder as the destination for scans.
  - ▶ **Setting a Shared Folder as a Save Location(P. 86)**
  - ▶ **Registering Destinations from Remote UI(P. 347)**
- You can save the Address Book as a file on your computer (although you cannot use the computer to edit the Address Book). You can also import a saved Address Book from the computer to the machine. ▶ **Saving/ Loading Address Book from Remote UI(P. 351)**
- You can print a list of destinations registered in the Address Book. ▶ **Address Book List (Touch Panel Model)(P. 457)**

# Registering Destinations in the Address Book

2KUU-037

This section describes how to register destinations from the operation panel. You can also use the Remote UI to register destinations. ▶ **Registering Destinations from Remote UI(P. 347)**

**1** Select <Addr. Book> in the Home screen. ▶ **Home Screen(P. 111)**

**2** Select <Regist Dest.>.

- If a screen appears prompting you to enter a PIN, enter the PIN for the Address Book and select <Apply>. ▶ **Restricting Use of the Address Book(P. 325)**

**3** Select <Coded Dial> ▶ **Select the type of address to register.**

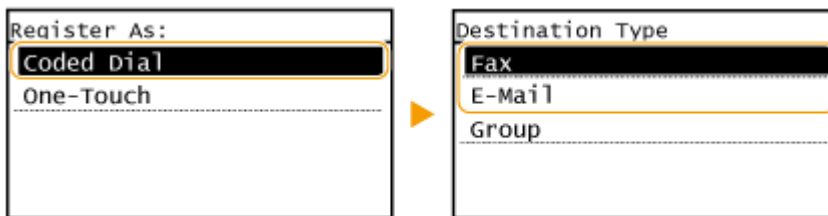

- According to the address being registered, select <Fax> or <E-Mail>.

**4** Select <Name>.

- Registering <Name> is optional. If you register <Name>, the destination can be searched alphabetically.

**5** Enter the name, and select <Apply>.

- On how to enter text, see ▶ **Entering Text(P. 123)** .

**6** Select <Fax Number> or <E-Mail Address>.

**7** Enter the destination, and select <Apply>.

## ■ Making detailed settings (only when registered for fax)

After selecting <Details>, a screen similar to the following is displayed.

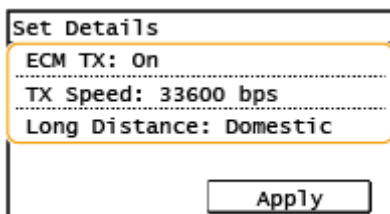

<ECM TX>

If an error occurs in an image that is being sent, the error is checked and corrected to prevent an improper image from being sent when setting <On>.

#### <TX Speed>

If it takes time for transmissions to start, such as when there is a poor telephone connection, you can adjust the transmission start speed downward.

#### <Long Distance>

Specify <International (1)> to <International (3)> according to the transmission conditions when registering overseas fax numbers.

## NOTE

- You can make detailed settings for destinations <Menu> ► <Fax Settings>. However, settings made from <Addr. Book> are enabled for the detailed settings of destinations registered in the Address Book.

## 8 Select <Apply>.

- A three-digit number is automatically set to destinations. The number can be edited after it has been registered.

## NOTE

- You can make a group of destinations already registered in the Address Book and register it as one destination. For more information, see ► **Registering Multiple Destinations as a Group(P. 167)** .
- When you want to change or delete items of information about destinations registered in the Address Book, see ► **Editing the Registered Destinations in the Address Book(P. 169)** .

# Registering Destinations for One-Touch Dial

2KUU-0A7

You can conveniently register frequently used destinations for One-Touch Dial. Destinations can be quickly displayed by selecting One-Touch buttons in the Home Screen. You can edit or delete destinations that you have registered. You can register up to 4 destinations for One-Touch Dial.

**1** Select <Addr. Book> in the Home screen. ▶ **Home Screen(P. 111)**

**2** Select <Regist Dest.>.

- If a screen appears prompting you to enter a PIN, enter the PIN for the Address Book and select <Apply>. ▶ **Restricting Use of the Address Book(P. 325)**

**3** Select <One-Touch> ▶ **Select the type of address to register.**

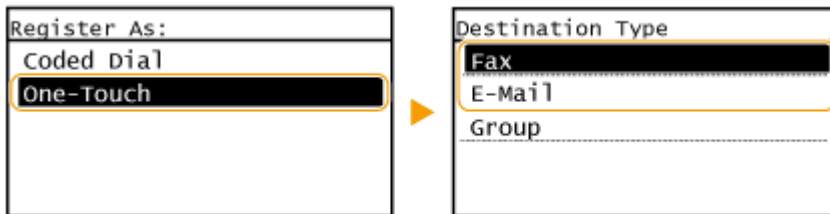

- According to the address being registered, select <Fax> or <E-Mail>.

**4** Select the number to register.

- You can change this number to another number later.

**5** Select <Name>.

- Registering <Name> is optional. If you register <Name>, the destination can be searched alphabetically.

**6** Enter the name, and select <Apply>.

- On how to enter text, see ▶ **Entering Text(P. 123)** .

**7** Select <Fax Number> or <E-Mail Address>.

**8** Enter the destination, and select <Apply>.

## ■ Making detailed settings (only when registered for fax)

After selecting <Details>, a screen similar to the following is displayed.

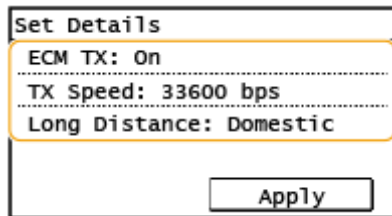

Set Details

ECM TX: On

TX Speed: 33600 bps

Long Distance: Domestic

Apply

**<ECM TX>**

If an error occurs in an image that is being sent, the error is checked and corrected to prevent an improper image from being sent when setting <On>.

**<TX Speed>**

If it takes time for transmissions to start, such as when there is a poor telephone connection, you can adjust the transmission start speed downward.

**<Long Distance>**

Specify <International (1)> to <International (3)> according to the transmission conditions when registering overseas fax numbers.

## NOTE

You can make detailed settings for destinations <Menu> ► <Fax Settings>. However, settings made from <Addr. Book> are enabled for the detailed settings of destinations registered in the Address Book.

## 9 Select <Apply>.

# Registering Multiple Destinations as a Group

2KUU-038

You can select multiple destinations that have already been registered and register them together as a group. This section describes how to register a group from the operation panel. You can also use the Remote UI to register a group. [▶Registering Destinations from Remote UI\(P. 347\)](#)

## NOTE

- Only destinations of the same type of address can be registered in the same group.
- Shared folders cannot be registered in a group as destinations.

**1** Select **<Addr. Book>** in the Home screen. [▶Home Screen\(P. 111\)](#)

**2** Select **<Regist Dest.>**.

- If a screen appears prompting you to enter a PIN, enter the PIN for the Address Book and select **<Apply>**. [▶Restricting Use of the Address Book\(P. 325\)](#)

**3** Select **<Coded Dial>** ▶ **<Group>**.

- Groups can also be registered in One-Touch Dial. Select **<One-Touch>** to register the group as a One-Touch Dial number.

**4** Select **<Name>**.

- Registering **<Name>** is optional. If you register **<Name>**, the destination can be searched alphabetically.

**5** Enter the name, and select **<Apply>**.

- On how to enter text, see [▶Entering Text\(P. 123\)](#) .

**6** Select **<Number of Destinations>**.

**7** Select **<Add>**.

**8** Select the index containing the destination you want to register. [▶Index\(P. 161\)](#)

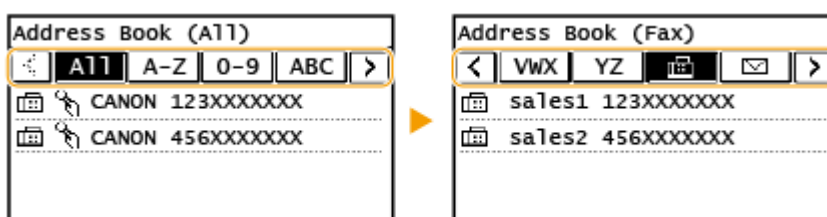

**9** Select the destination.

**10** Repeat steps 7 to 9 until you have registered all of the destinations that you want to register, and then select <Apply>.

**NOTE:**

**To view information about the destination**

- Select the target destination.

**To remove a destination from the group**

- Select the destination that you want to remove from the group, and select <Remove> ► <Yes>.

**11** Select <Apply>.

## Editing the Registered Destinations in the Address Book

2KUU-039

You can change your settings, such as changing a registered fax number or name, changing the type of destination registered as a fax number to an e-mail destination, changing a coded dial number, and adding or deleting group destinations. You can also delete destinations or groups.

- 1 Select <Addr. Book> in the Home screen. ▶ Home Screen(P. 111)
- 2 Select <Details/Edit>.
- 3 Select the index containing the destination you want to edit. ▶ Index(P. 161)

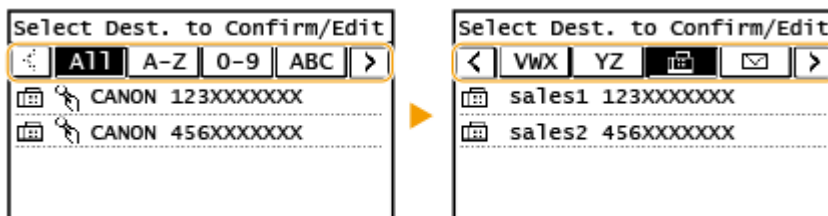

- 4 Select the destination, and select <Edit>.
  - To delete the destination, select <Delete> ▶ <Yes>.
  - If a screen appears prompting you to enter a PIN, enter the PIN for the Address Book and select <Apply>. ▶ Restricting Use of the Address Book(P. 325)
- 5 After editing the necessary items, select <Apply>.



# Copying

<b>Copying</b> .....	171
<b>Basic Copy Operations</b> .....	173
Canceling Copies .....	177
Checking the Copying Status and Log .....	179
<b>Enhancing and Adjusting Copy Quality</b> .....	180
Selecting the Type of Original for Copying .....	181
Adjusting Sharpness for Copying (Sharpness) .....	182
<b>Useful Copy Functions</b> .....	184
Copying Multiple Documents onto One Sheet (N on 1) .....	185
Using <Paper Save Copy> .....	187
Collating Copies by Page .....	188
Making ID Card Copies .....	189
Making Passport Copy .....	190

# Copying

2KUU-03A

This chapter describes basic copy operations and various other useful functions, such as 2-sided copying and ID card copy.

## ■ Using Basic Operations

- ▶ Basic Copy Operations(P. 173)
- ▶ Canceling Copies(P. 177)
- ▶ Checking the Copying Status and Log(P. 179)

## ■ Enhancing Quality ▶ Enhancing and Adjusting Copy Quality(P. 180)

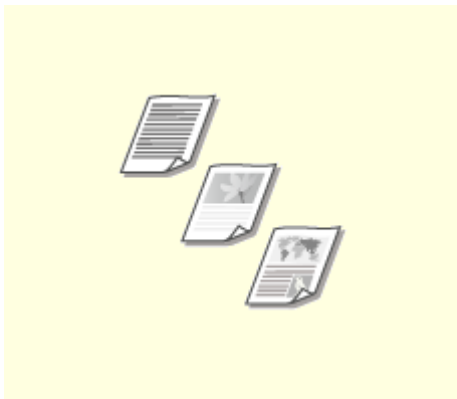

▶ Selecting the Type of Original for Copying(P. 181)

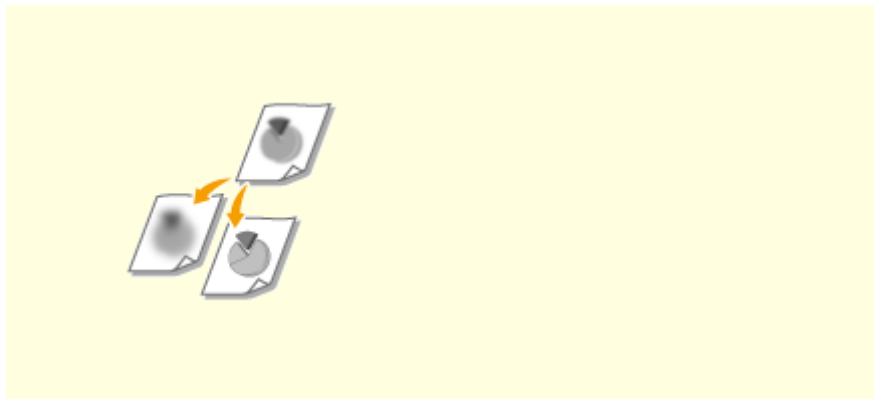

▶ Adjusting Sharpness for Copying (Sharpness)(P. 182)

## ■ Using Useful Copy Functions ▶ Useful Copy Functions(P. 184)



▶ Copying Multiple Documents onto One Sheet (N on 1)(P. 185)



▶ Using <Paper Save Copy>(P. 187)



▶ Collating Copies by Page(P. 188)



▶ Making ID Card Copies(P. 189)



▶ Making Passport Copy(P. 190)

# Basic Copy Operations

This section describes the basic operation procedure used to copy an original.

## 1 Place the original(s). ▶ Placing Originals(P. 128)

## 2 Display the <Copy> screen. ▶ Home Screen(P. 111)

### Touch Panel Model

Select <Copy> in the Home screen.

### 5 Lines LCD Model

Press  (COPY/SCAN).

## 3 Enter the number of copies using the numeric keys.

- If you have entered an incorrect value, use  to clear it.

## 4 Specify the copy settings as necessary.

- ▶ Adjusting Density
- ▶ 2-Sided Copying
- ▶ Enlarging or Reducing

## Adjusting Density



Adjust the density of the scan if the text or images in an original are excessively light or dark. You can also automatically set an optimal density for an original.



<Density> ▶ Adjust the density ▶ <Apply> ()

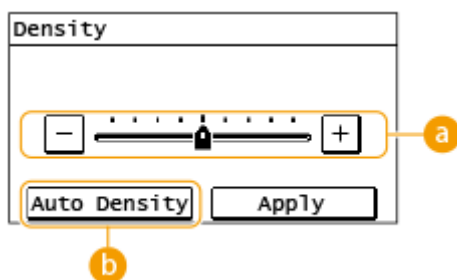

**a Manual Density**

Adjust the density manually.

**b <Auto Density>**

An optimal density for the original is automatically set. <Original Type> is automatically set to <Text>. ▶ **Selecting the Type of Original for Copying(P. 181)**

2-Sided Copying



You can copy two pages of an original on both sides of the paper. You can also copy a 2-sided original on both sides of the paper, or on two sheets of paper.

**NOTE**

- <2-Sided> may not be available with some sizes and types of paper. ▶ **Available Paper(P. 538)**
- <2-Sided> is not available when using <Paper Save>/<Paper Save Copy>, <ID Card Cpy>/<ID Card Copy>, or <Passprt Cpy>/<Passport Copy>.

<2-Sided> ▶ Select the type of 2-sided copying

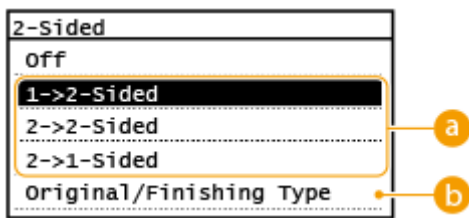

**a Types of 2-sided copying**

The illustration below shows the types of 2-sided copying.

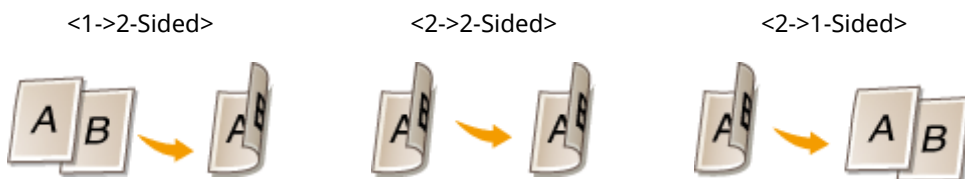

**b <Original/Finishing Type>**

Specify the original orientation, opening type, and finishing type.

## Enlarging or Reducing



You can enlarge or reduce copies by using a preset copy ratio such as <129% STMT->LTR>, or by setting a custom copy ratio in increments of 1 %.

### NOTE

- If you make a setting for <N on 1> after setting the copy ratio, the setting of reduction ratio in <N on 1> takes priority.



<Copy Ratio> ▶ Select the copy ratio

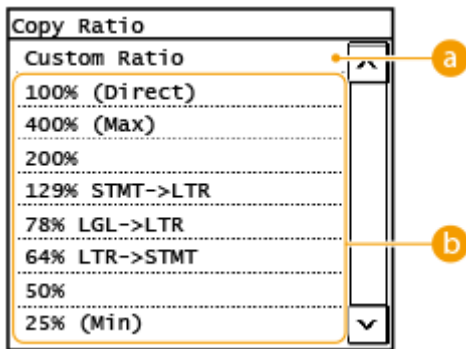

#### a <Custom Ratio>

You can set any copy ratio from 25 to 400% in 1% increments.

#### b Preset copy ratio

Select a copy ratio.

### NOTE:

- For information about other copy settings, see [▶ Enhancing and Adjusting Copy Quality\(P. 180\)](#) or [▶ Useful Copy Functions\(P. 184\)](#) .

## 5 Press .

⇒ Copying starts.

- If you want to cancel, select <Cancel> ▶ <Yes>. [▶ Canceling Copies\(P. 177\)](#)

### ■ When placing originals in the feeder in step 1

The original is automatically scanned.

## ■When placing originals on the platen glass in step 1

If you have set 2-sided copying, N on 1 copying, or collating, a screen prompting you to load the next original is displayed.

- 1 Select the document size.
  - Only displayed when 2-sided copying is set.
- 2 Place the next original on the platen glass, and press .
  - You can also specify <Density> and <Original Type> separately for each original.

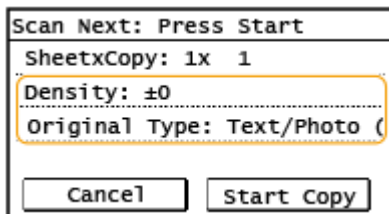

- Repeat this step until you finish scanning the entire original.
- 3 Select <Start Copy>/<Start Copying>.

### NOTE:

- When the <Size/Settings Mismatch> or <The memory is full. Scanning will be canceled. Do you want to print?>/<The memory is full. Scanning will be canceled. Print?> message is shown in the display.  **Countermeasures for Each Message(P. 491)**

## IMPORTANT

### When copying originals with text or images that extend to the edges of the page

- The edges of the original might not be copied. For more information about the scan margins, see  **Main Unit(P. 533)** .



## TIPS

- If you always want to make copies with the same settings:  **Changing the Default Settings for Functions(P. 154)**

## LINKS

-  **Checking the Copying Status and Log(P. 179)**

## Canceling Copies

If you want to cancel copying immediately after pressing , select <Cancel> on the screen or press  on the operation panel. You can also cancel copying after checking the copy status.

### ■ Select <Cancel> on the Screen That is Displayed While Copying

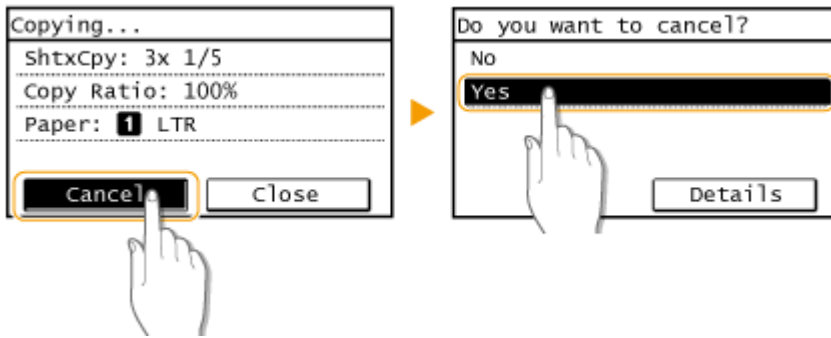

### ■ Press to Cancel

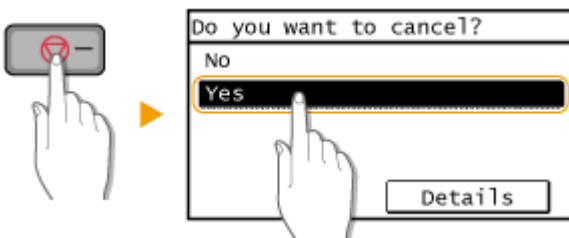

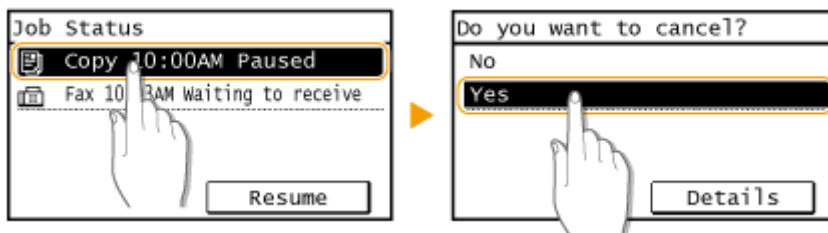

### If the Screen Displays a List of Documents When is Pressed

Originals have been scanned and are waiting to be printed. Select a copy document to be canceled, and select <Yes>.



### ■ Check the copy job status before canceling



 ▶ <Copy/Print Job> ▶ <Job Status> ▶ Select the copy document in the <Copy/Print Job Status> screen ▶ <Cancel> ▶ <Yes>



LINKS

---

▶ **Basic Copy Operations(P. 173)**

# Checking the Copying Status and Log

2KUU-03H

You can check the current copy statuses and the logs for copied documents.

## IMPORTANT

- When <Display Job Log> is set to <Off>, you cannot check the copy job log. [▶<Display Job Log>\(P. 425\)](#)

### Useful in the Following Cases

- When some long time has already passed after scanning of your original to be copied but printing of the document has not started yet, you may want to see the waiting list of the documents waiting to be printed.
- When you cannot find your printouts that you thought had been copied, you may want to see whether an error has occurred.

**1** Press .

**2** Select <Copy/Print Job>.

**3** Select <Job Status> and select the document whose status you want to check.

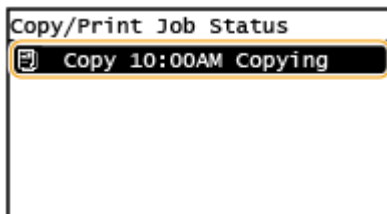

⇒ Displays detailed information about the document.

## LINKS

- [Basic Copy Operations\(P. 173\)](#)
- [Canceling Copies\(P. 177\)](#)

## Enhancing and Adjusting Copy Quality

---

2KUU-03J

You can improve the copy quality by specifying more detailed settings, such as adjusting the brightness, erasing unnecessary shadows, etc.



▶ **Selecting the Type of Original for Copying(P. 181)**

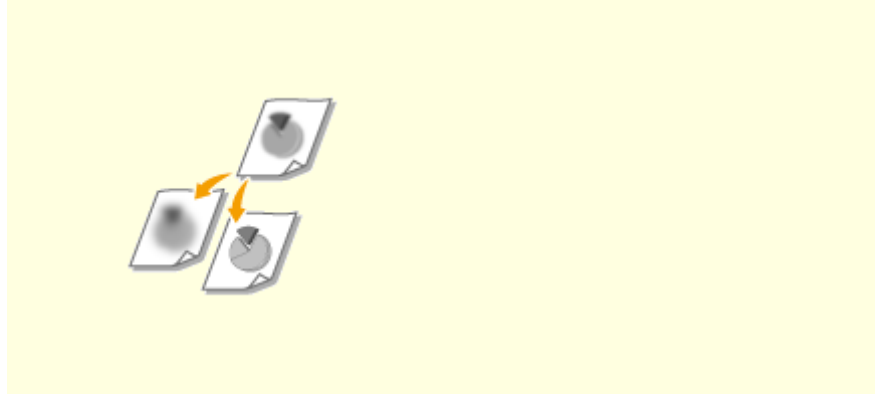

▶ **Adjusting Sharpness for Copying (Sharpness)(P. 182)**

# Selecting the Type of Original for Copying

2KUU-03K



You can select the optical image quality for the copy depending on the original type, such as text-only documents, documents with charts and graphs, or magazine photos.

## Touch Panel Model



<Copy> ▶ <Original Type> ▶ Select the original type

## 5 Lines LCD Model



(COPY/SCAN) ▶ <Original Type> ▶ Select the original type

<Text>	Suitable when copying originals that only contain text.
<Text/Photo (High Speed)>	Suitable when copying originals that contain both text and photos. Priority is given to speed over image quality.
<Text/Photo>	Suitable when copying originals that contain both text and photos.
<Photo>	Suitable when copying originals that contain printed photos, such as magazines or pamphlets.

## NOTE

- If <Text/Photo (High Speed)>, <Text/Photo>, or <Photo> is selected while <Density> is set to <Auto Density>, density setting changes to Manual Density.

## LINKS

➤ [Basic Copy Operations\(P. 173\)](#)

# Adjusting Sharpness for Copying (Sharpness)

2KUU-03L





You can adjust sharpness of the copied image. Increase the sharpness to sharpen blurred text and lines, or decrease the sharpness to improve the appearance of magazine photos.

## Touch Panel Model

 <Copy> ▶ <Sharpness> ▶ Adjust the sharpness ▶ <Apply>

## 5 Lines LCD Model

  (COPY/SCAN) ▶ <Sharpness> ▶ Adjust the sharpness

**Example:** If you want to sharpen text and lines written in pencil

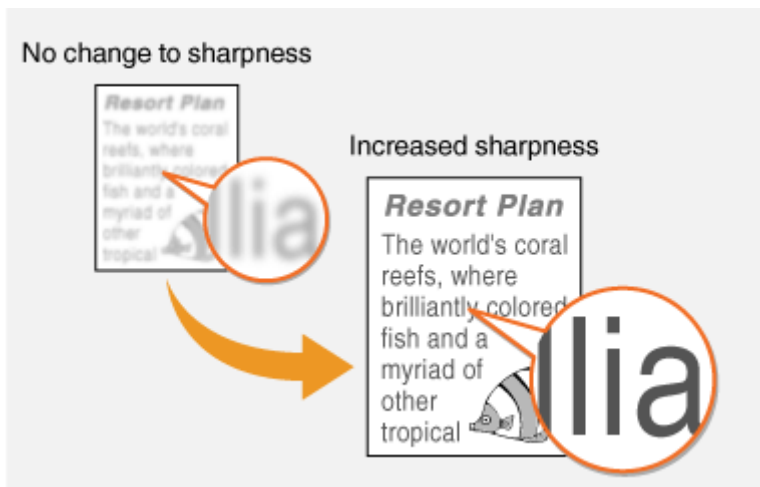

**Example:** If you want to improve the appearance of magazine photos

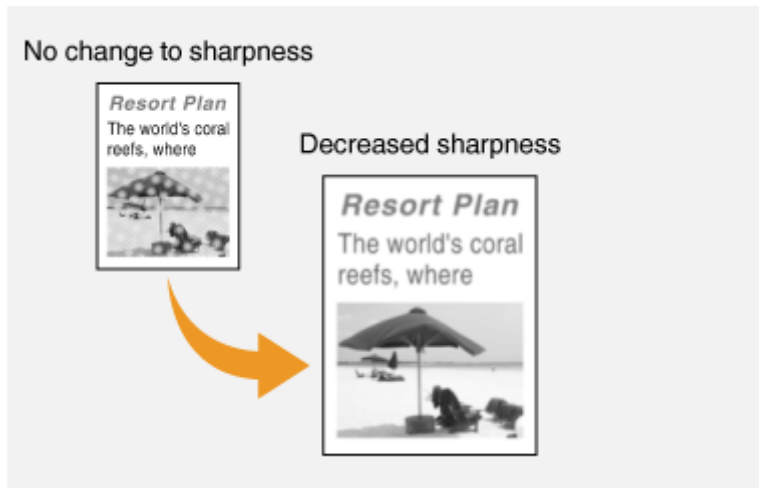

LINKS

---

▶ Basic Copy Operations(P. 173)

## Useful Copy Functions

2KUU-03R

You can copy multiple sheets onto one page, or copy by grouping sheets into complete sets in sequential page order. Also, there is a function to copy both sides of a card, etc. onto one page.



▶ Copying Multiple Documents onto One Sheet (N on 1)(P. 185)



▶ Using <Paper Save Copy>(P. 187)



▶ Collating Copies by Page(P. 188)



▶ Making ID Card Copies(P. 189)



▶ Making Passport Copy(P. 190)



# Copying Multiple Documents onto One Sheet (N on 1)

2KUU-03S





You can copy two or four documents onto a single sheet at a reduced size. This decreases the number of pages, enabling you to save paper.

## NOTE

- Using <N on 1> reduces the copy ratio automatically (the copy ratio is displayed on the screen). You can increase or further reduce the copy ratio before pressing , but the edges of the original might not be copied if you increase it.
- <N on 1> is not available when using <Paper Save> () , <ID Card Cpy>/<ID Card Copy> , or <Passprt Cpy>/<Passport Copy> .
- When you copy multiple originals onto one page, margins may be created in the copied image.

## TIPS

- Using the <Paper Save> () enables you to combine 2-sided copying and <N on 1>:  **Using <Paper Save Copy>(P. 187)**

### Touch Panel Model



<Copy> ▶ <N on 1> ▶ Select <2 on 1> or <4 on 1> ▶ Select the original size on the <Scan Size> screen

### 5 Lines LCD Model



 (COPY/SCAN) ▶ <N on 1> ▶ Select <2 on 1> or <4 on 1> ▶ Select the original size on the <Scan Size> screen

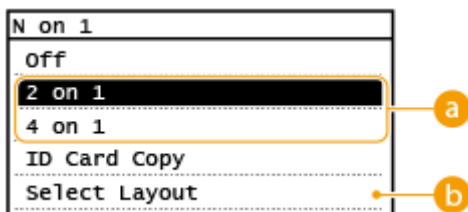

### **a** Number of pages to be combined

Select the number of pages to be combined on one side of paper. For example, <4 on 1> means that "a four-page original can be combined on a single sheet."



**b <Select Layout>**

Specify how to arrange the originals on the page.

LINKS

---

- ▶ **Basic Copy Operations(P. 173)**
- ▶ **Using <Paper Save Copy>(P. 187)**

## Using <Paper Save Copy>



You can use <Paper Save> ( **Paper Save Copy** ) to perform N on 1 copying and also copying onto both sides of a page at the same time with a single operation, allowing you to save paper. It also saves you from having to set each function separately.

### NOTE

- Using <Paper Save> ( **Paper Save Copy** ) reduces the copy ratio automatically (the copy ratio is displayed on the screen). You can increase or further reduce the copy ratio before pressing , but the edges of the document might not be copied if you increase it.
- <Paper Save> ( **Paper Save Copy** ) is not available when using <2-Sided>, <N on 1>, <ID Card Cpy>/<ID Card Copy> or <Passprt Cpy>/<Passport Copy>.
- When you copy multiple documents onto one page, margins may be created in the copied image.



<Paper Save> ( **Paper Save Copy** ) ▶ Select the paper save copy setting ▶ Select the document size on the <Scan Size> screen

### LINKS

▶ **Basic Copy Operations(P. 173)**

# Collating Copies by Page





When preparing multiple copies of multi-page originals, set <Collate> to <On> to collate copies in sequential page order. This function is useful when preparing handouts for meetings or presentations.

### Touch Panel Model

 <Copy> ▶ <Collate> ▶ <On>

### 5 Lines LCD Model

  (COPY/SCAN) ▶ <Collate> ▶ <On>



#### <Off>

The copies are grouped by page and not collated. For example, if you are making three copies of a five-page original, the printouts will be arranged in the following page order: 1, 1, 1, 2, 2, 2, 3, 3, 3, 4, 4, 4, 5, 5, 5.



#### <On>

The copies are grouped into complete sets in sequential page order. For example, if you are making three copies of a five-page original, the printouts will be arranged in the following page order: 1, 2, 3, 4, 5, 1, 2, 3, 4, 5, 1, 2, 3, 4, 5.



## LINKS

[Basic Copy Operations\(P. 173\)](#)

# Making ID Card Copies

2KUU-03W





You can use <ID Card Cpy>/<ID Card Copy> to copy the front and back sides of a card onto the same side of a page. This function is useful when copying a driver's license or ID card.





## NOTE

- <ID Card Cpy>/<ID Card Copy> is not available when using <Paper Save>/<Paper Save Copy>, <2-Sided>, <N on 1>, <Copy Ratio>, or <Passprt Cpy>/<Passport Copy>.

### Touch Panel Model

 Place the card on the platen glass ▶ <ID Card Cpy> ▶  ▶ Turn the card over ▶ 

### 5 Lines LCD Model

 Place the card on the platen glass ▶  (ID Card Copy) ▶  ▶ Turn the card over ▶ 

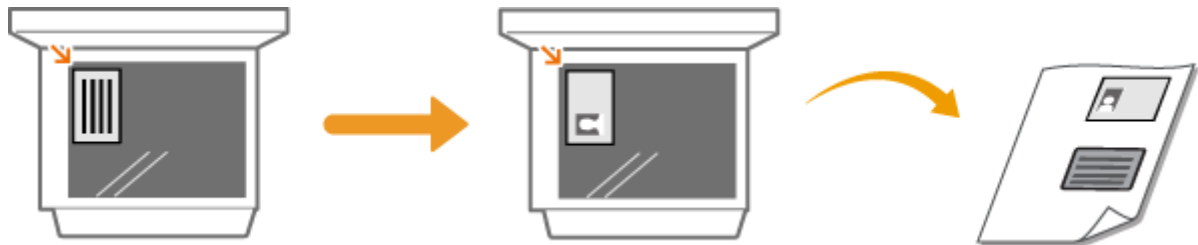

## LINKS

- [Basic Copy Operations\(P. 173\)](#)

## Making Passport Copy

2KUU-03X





Copy passports for several individuals laid out on a single sheet of paper. This is convenient such as when copying passports as a receptionist duty.

### NOTE

- Using Passport Copy reduces the copy ratio automatically (the copy ratio is displayed on the screen). If the copying process has not started, you can further reduce the image size by lowering the numeric value that is automatically displayed. The value can also be increased, but the edges of the original might not be copied.
- Scan size is fixed at 5 1/8" (130 mm) x 7 1/8" (180 mm).
- The order of layout cannot be set.
- <Passprt Cpy>/<Passport Copy> is not available when using <Paper Save>/<Paper Save Copy>, <N on 1>, or <ID Card Cpy>/<ID Card Copy>.
- The 2-sided copying setting cannot be changed.



#### Touch Panel Model



Place one of the passports on the platen glass ▶ <Passprt Cpy> ▶ Specify the layout ▶  ▶ Place the next passport,  ▶ Repeat until all passport originals have been scanned ▶ <Start Copy>

#### 5 Lines LCD Model



Place one of the passports on the platen glass ▶  (COPY/SCAN) ▶ <Passport Copy> ▶ Specify the layout ▶  ▶ Place the next passport,  ▶ Repeat until all passport originals have been scanned ▶ <Start Copying>

## Copying



## LINKS

---

🔗 **Basic Copy Operations(P. 173)**

# Faxing

<b>Faxing</b> .....	193
<b>Basic Operations for Sending Faxes</b> .....	195
Canceling Sending Faxes .....	202
<b>Receiving Faxes</b> .....	203
<b>Useful Functions When Sending</b> .....	207
Recalling Previously Used Settings for Sending (Recall Settings) .....	208
Sending a Fax after a Phone Call (Manual Sending) .....	210
<b>Various Receiving Methods</b> .....	212
Saving Received Documents into the Machine (Memory Reception) .....	213
<b>Forwarding the Received Documents Automatically</b> .....	215
<b>Checking Status and Log for Sent and Received Documents</b> .....	217
<b>Sending Faxes from Your Computer (PC Fax)</b> .....	219
Sending PC Faxes .....	220

# Faxing

2KUU-03Y

This chapter describes fax settings, basic fax operations and various other useful functions to suit your needs, such as PC Fax to send documents directly from computers, Address Book to specify destinations easily, and Forwarding to receive faxes even when you are out of the office.

## NOTE

- You need to complete some procedures before using fax functions. ▶ **Configuring Initial Settings for Fax Functions(P. 70)**
- You need to register destinations in the Address Book before using this feature. ▶ **Registering Destinations(P. 161)**

### ■ Using Basic Operations

- ▶ **Basic Operations for Sending Faxes(P. 195)**
- ▶ **Canceling Sending Faxes(P. 202)**
- ▶ **Receiving Faxes(P. 203)**
- ▶ **Checking Status and Log for Sent and Received Documents(P. 217)**

### ■ Using Useful Functions When Sending ▶ **Useful Functions When Sending(P. 207)**



▶ **Recalling Previously Used Settings for Sending (Recall Settings)(P. 208)**



▶ **Sending a Fax after a Phone Call (Manual Sending)(P. 210)**

### ■ Receiving According to Your Purposes ▶ **Various Receiving Methods(P. 212)**





▶ **Saving Received Documents into the Machine (Memory Reception)(P. 213)**

■ **Forwarding All the Received Documents**

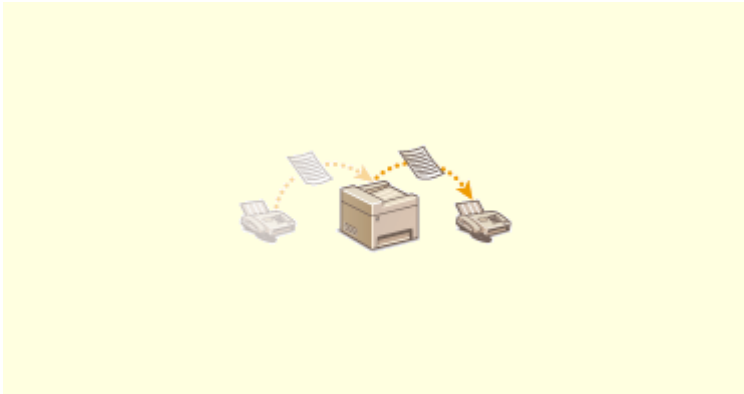

▶ **Forwarding the Received Documents Automatically(P. 215)**

■ **Sending Faxes Directly from Your Computer**

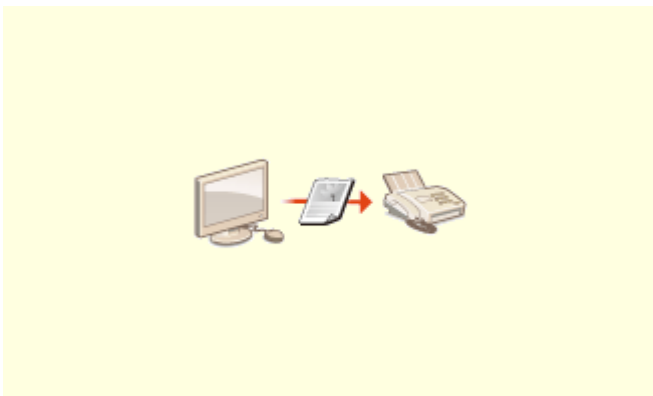

▶ **Sending Faxes from Your Computer (PC Fax)(P. 219)**

# Basic Operations for Sending Faxes

2KUU-041

This section describes the basic operation procedure used to fax an original.

## NOTE

- You need to complete some procedures before using fax functions. ▶ **Configuring Initial Settings for Fax Functions(P. 70)**

**1 Place the original(s).** ▶ **Placing Originals(P. 128)**

**2 Select <Fax> in the Home screen.** ▶ **Home Screen(P. 111)**

**3 Press .**

- If the destinations set by the previous user are still selected, this can cause transmission errors. Always reset the settings before sending.

**4 Specify the destination.**

- ▶ Specifying from Address Book
- ▶ Specifying from Coded Dial Numbers
- ▶ Specifying from One-Touch
- ▶ Entering Destinations Directly

## Specifying from Address Book



The Address Book enables you to specify a destination by selecting from a list of registered destinations or by searching by name for destinations with recipient names.

## NOTE

- You need to register destinations in the Address Book before using this feature. ▶ **Registering Destinations(P. 161)**

**1 Select <Destination> ▶ <Specify from Address Book>.**

**2 Select an index.** ▶ **Index(P. 161)**

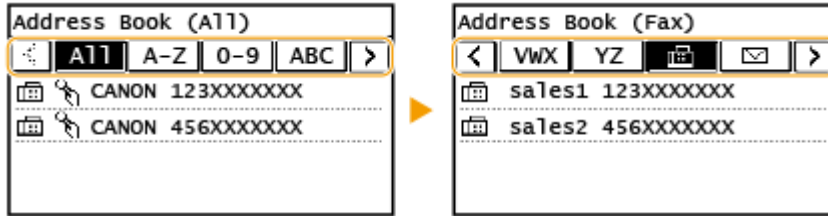

### 3 Select a destination.

## TIPS

- If a destination is selected from <Addr. Book> in the Home screen, the Fax Basic Features screen can be displayed while the selected destination remains being specified.

## Specifying from Coded Dial Numbers



Three-digit numbers (coded dial numbers) are assigned to addresses in the Address Book. You can specify an address simply by entering its coded dial number.

## NOTE

- To use coded dial numbers, the destination must be registered in the Address Book beforehand. [▶ Registering Destinations\(P. 161\)](#)

### 1 Select <Destination> ▶ <Specify from Coded Dial>.

### 2 Enter a three-digit number.

- If you have entered an incorrect value, use **C** to clear it.

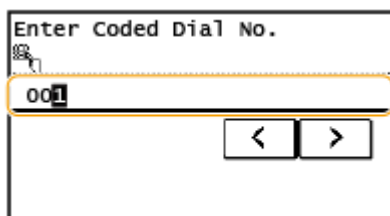

## NOTE:

### If a confirmation screen appears

- When <One-Touch/Coded Dial TX Confirmation> is set to <On>, a screen is displayed that shows the destination and the name for the number. (For Group Dial, the group name and the number of destinations are shown.) Check the contents and if everything is correct, select <OK>. To specify a different destination, select <Cancel> and then re-enter the three-digit coded dial number. [▶ Displaying Destinations in Address Book\(P. 327\)](#)

## TIPS

- If a coded dial number is selected from <Coded Dial> in the Home screen, the Fax Basic Features screen can be displayed while the selected destination remains being specified.

## Specifying from One-Touch



Specify a destination by selecting from a list registered to the one-touch buttons.

## NOTE

- You need to register destinations before using one-touch dialing. ▶ **Registering Destinations in the Address Book(P. 163)**

**1** Select <Destination> ▶ <Specify from One-Touch>.

**2** Select a destination.

### NOTE:

#### If a confirmation screen appears

- When <One-Touch/Coded Dial TX Confirmation> is set to <On>, a screen is displayed that shows the destination and destination name registered to the one-touch button. (For Group Dial, the group name and the number of destinations are shown). Check the contents and if everything is correct, select <OK>. To specify a different destination, select <Cancel> and then select the one-touch buttons again.

## TIPS

- If you select any of <One-Touch 1> to <One-Touch 4> in the Home screen, the Fax Basic Features screen can be displayed while the selected destination remains being specified.

## Entering Destinations Directly

For a destination that is not registered in the Address Book, specify it by entering a fax number.

**1** Select <Destination> ▶ <Specify Using Numeric Keys>.

**2** Enter the fax number.

- If you have entered an incorrect value, press  to clear it.

## NOTE

### If a confirmation screen appears

- When <Confirm Entered Fax Number> is set to <On>, the input screen reappears so that you can confirm the destination ( ▶ **Confirming the Entered Fax Number(P. 329)** ). Enter the destination again.

### Sending a fax abroad

- Enter the international access code, the country code, and the fax number to specify the destination. If you are not able to successfully connect to a recipient, select <Pause> and insert a pause between numbers.

## NOTE:

### Adding a destination

- To send a fax to multiple destinations at a time (sequential broadcast), repeat the appropriate steps to enter all destinations.
- You can also recall previously used destinations. ▶ **Recalling Previously Used Settings for Sending (Recall Settings)(P. 208)**

### ■ To delete destinations

If you specified multiple destinations, you can delete destinations as necessary.

- 1 Select <Destination> ▶ <Confirm/Edit>.
- 2 Select a destination you want to delete.
  - If you specified Group Dial, "XX destination(s)" is displayed. Selecting <Number of Destinations> displays destinations registered in the group.
- 3 Select <Remove> ▶ <Yes>.

## 3 Specify the scanning settings as necessary.

- ▶ Adjusting Image Quality
- ▶ Scanning 2-Sided Originals

## Adjusting Image Quality



You can select the resolution suitable for your original type. The higher the resolution is, the clearer the image becomes, but the longer it takes to send. ▶ **Selecting Resolution(P. 199)**



You can adjust the density of the fax if the text or images in an original are too light or dark. ▶ **Adjusting Density(P. 199)**



You can adjust the sharpness of the image. Increase the sharpness to sharpen blurred text and lines, or decrease the sharpness to improve the appearance of magazine photos. **▶ Adjusting Sharpness(P. 199)**

### ■ Selecting Resolution

 <Resolution> ▶ Select the resolution

### ■ Adjusting Density

 <Density> ▶ Adjust the density ▶ <Apply>

### ■ Adjusting Sharpness

 <Sharpness> ▶ Adjust the sharpness ▶ <Apply>

**Example:** If you want to sharpen text and lines written in pencil

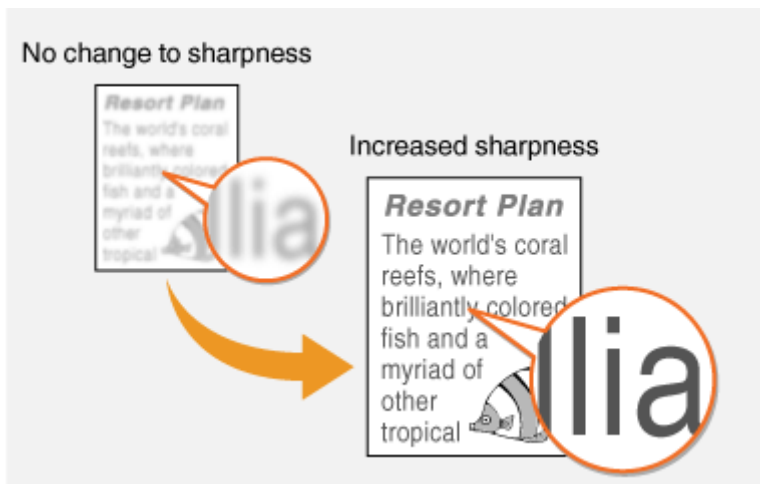

**Example:** If you want to improve the appearance of magazine photos

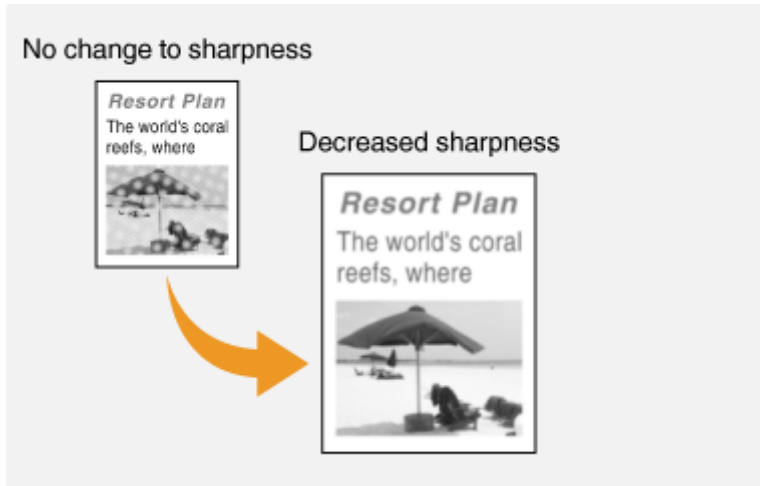

## Scanning 2-Sided Originals



The machine can automatically scan the front and back sides of originals in the feeder.

### IMPORTANT

- The machine cannot scan both sides of originals automatically when the originals are placed on the platen glass or when the machine is set to Manual Sending.



<2-Sided Original> ▶ Select <Book Type> or <Calendar Type>

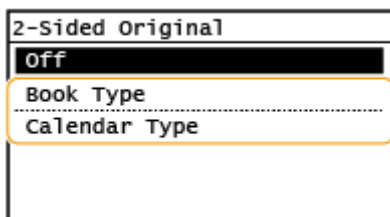

#### <Book Type>

Select for originals whose images on the front and back sides face the same direction.

#### <Calendar Type>

Select for originals whose images on the front and back sides face in opposite directions.

### 4 Press .

⇒ Scanning of the original starts.

- If you want to cancel, select <Cancel> ▶ <Yes>.  **Canceling Sending Faxes(P. 202)**

**■When placing originals in the feeder in step 1**



When scanning is complete, the faxes are sent.

**■When placing originals on the platen glass in step 1**

When scanning is complete, follow the procedure below.



- 1** Select the original size.
  - When there is only one page to be scanned, proceed to step 3.
- 2** Place the next original on the platen glass, and press  .
  - Repeat this step until you finish scanning all of the pages.
- 3** Select <Start TX>.
  - ▣ The faxes are sent.

## TIPS

- If you always want to send faxes with the same settings:  **Changing the Default Settings for Functions(P. 154)**
- If you want to sound an alarm when the handset is off the hook:  **<Off-Hook Alarm>(P. 389)**



## LINKS

---

-  **Canceling Sending Faxes(P. 202)**
-  **Useful Functions When Sending(P. 207)**
-  **Checking Status and Log for Sent and Received Documents(P. 217)**



## Canceling Sending Faxes

If you want to cancel sending faxes immediately after pressing , select <Cancel> on the display or press  on the operation panel. You can also cancel sending faxes after checking the fax status.

### ■ Select <Cancel> on the screen during fax transmission

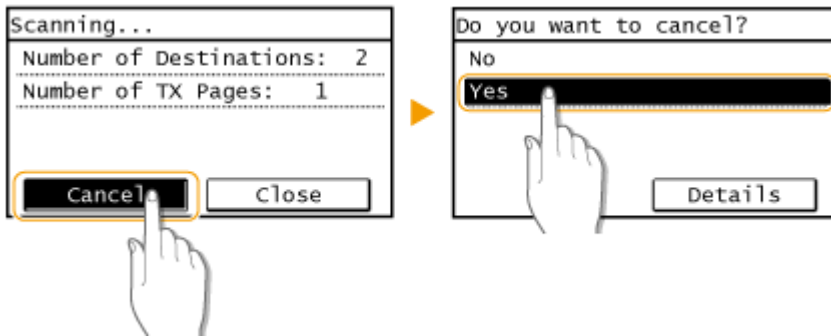

### ■ Press to cancel

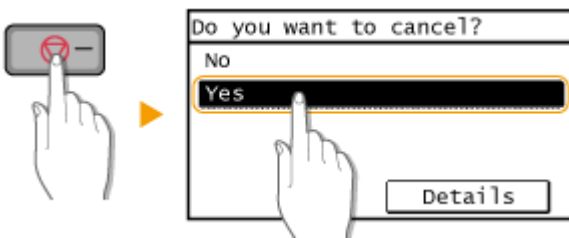

### If the screen displays a list of documents when is pressed

Originals have been scanned and are waiting to be processed. Select the document to cancel, and select <Yes>.

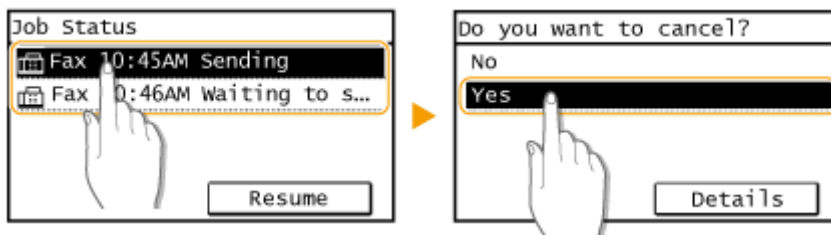

### ■ Check the transmission status before canceling

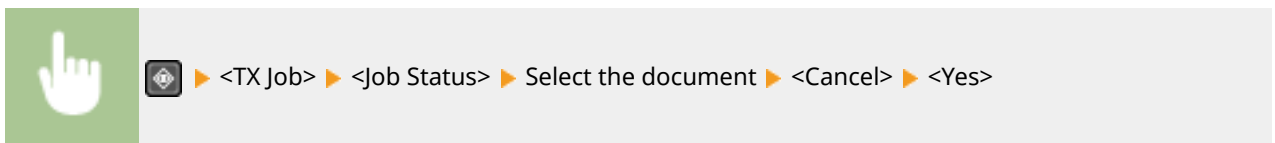

### LINKS

- ▶ Basic Operations for Sending Faxes(P. 195)
- ▶ Checking Status and Log for Sent and Received Documents(P. 217)

# Receiving Faxes

2KUU-043





This section describes the methods for receiving faxes and how to set up the machine to receive faxes. You need to complete some procedures for using fax functions before specifying the receiving settings. **▶Configuring Initial Settings for Fax Functions(P. 70)**



## NOTE

- The machine can print received fax documents on A4 or Letter size paper. If received fax documents are printed on other paper sizes, a portion of the page may not be printed or a page may be printed on two separate sheets of paper.

### ■ Methods for Receiving Faxes

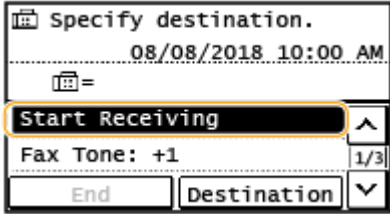
The machine provides the following receiving methods. Select the method that best suits your needs and then set it up by following the procedure in **▶Setting Up the Machine to Receive Faxes(P. 204)** .

<p>&lt;Auto&gt;</p> 	<p><b>Dedicated to receiving faxes</b></p> <p>The machine receives faxes automatically. Even if someone makes a call to you, you cannot talk to the caller.</p>
<p>&lt;Fax/Tel (Auto Switch)&gt;</p> 	<p><b>When the call is a fax</b></p> <p>The machine receives the fax automatically.</p> <p><b>When the call is a telephone call</b></p> <p>An incoming call rings. Pick up the handset to answer the call.</p> <p><b>NOTE:</b></p> <ul style="list-style-type: none"> <li>• You need to connect your telephone to the machine beforehand.</li> </ul>
<p>&lt;Manual&gt;</p> 	<p><b>When the call is a fax</b></p> <p>An incoming call rings. Pick up the handset. If you hear a beep, select  ▶ &lt;Fax&gt; ▶ &lt;Start Receiving&gt; to receive faxes.</p>  <p><b>When the call is a telephone call</b></p> <p>An incoming call rings. Pick up the handset and start your conversation.</p> <p><b>NOTE:</b></p> <ul style="list-style-type: none"> <li>• You need to connect your telephone to the machine beforehand.</li> </ul>

	<ul style="list-style-type: none"> <li>You can set the machine to automatically receive faxes when an incoming call rings within a specified timeframe. ▶&lt;Switch to Auto RX&gt;(P. 396)</li> </ul>
<p>&lt;Answering Machine&gt;</p> 	<p><b>When the call is a fax</b> After an incoming call rings, the machine receives the fax automatically.</p> <p><b>When the call is a telephone call</b> The answering machine activates, enabling the caller to leave a message. If you pick up the handset before the answering machine starts recording a message, you can talk with the caller.</p> <p><b>NOTE:</b></p> <ul style="list-style-type: none"> <li>You need to connect your answering machine to the machine beforehand.</li> <li>Set the answering machine to answer after a few rings.</li> <li>We recommend that you add approximately 4 seconds of silence at the beginning of the message or set the maximum recording time to 20 seconds.</li> </ul>
<p>&lt;DRPD: Select Fax&gt;</p> 	<p>If you have subscribed to a Distinctive Ring Pattern Detection (DRPD) service provided by your telephone company, this receiving mode is available. This service assigns two or more telephone numbers with distinctive ring patterns to a single telephone line. You can use one of these numbers for faxes and one for telephone calls.</p> <p>When the machine receives a call, it automatically recognizes the ring pattern and your telephone rings differently depending on whether the call is a fax or telephone call. If the ring pattern is for a fax, the machine automatically receives the fax.</p> <p><b>NOTE:</b></p> <ul style="list-style-type: none"> <li>For more information about this service, contact your telephone company.</li> <li>You need to connect your telephone to the machine beforehand.</li> </ul>

## NOTE

- Depending on the type of telephone connected to it, the machine may not be able to send or receive faxes properly.
- If you are connecting an external telephone with fax functions, set the telephone to not receive faxes automatically.
- If you pick up the telephone handset and hear a beep, the call is a fax. You can receive the fax just by using the telephone to enter a specific ID number. ▶<Using a Telephone to Receive Faxes (Remote Reception)> (P. 205)

### ■ Setting Up the Machine to Receive Faxes

- 1 Select <Fax> in the Home screen. ▶<Home Screen>(P. 111)
- 2 Select <RX Mode>.
- 3 Select the receiving method.

### ■ When selecting <Fax/Tel (Auto Switch)>

Specify the following three settings as necessary. When the setting is complete, select <Apply>.

Fax/Tel (Auto Switch)	
Ring Start Time:	6
Incoming Ring Time:	15
After Ring:	Receive
<input type="button" value="Apply"/>	

#### <Ring Start Time>

Enables you to specify the duration during which the machine determines whether an incoming call is a fax or a telephone call.

#### <Incoming Ring Time>

Enables you to specify the duration during which an incoming call rings for a telephone call.

#### <After Ring>

Enables you to specify how the machine operates if you do not pick up the handset while an incoming call is ringing. Select <End> to disconnect the call or <Receive> to receive an incoming fax.

### ■ When selecting <DRPD: Select Fax>

Select the ring pattern that your telephone company assigned to your fax number.

## TIPS

- If you want to print received documents on both sides of paper: ▶<Print on Both Sides>(P. 397)
- If you want to print information, such as reception date and time, at the bottom of received documents: ▶<RX Page Footer>(P. 397)
- If you want to continue printing even when the amount remaining in the toner cartridge is low: ▶<Continue Print. When Near Cart. Life End>(P. 398)

### ■ Using a Telephone to Receive Faxes (Remote Reception)

When you pick up the telephone and get a fax signal, you do not need to go to the machine to receive the fax. Just enter a specific ID number with the telephone, and you can start receiving the fax.

## NOTE

- When the telephone is not directly connected with the machine, the remote reception function is not available.

**1** When an incoming call rings, pick up the telephone handset.

**2** If you hear a beep, enter the ID number for Remote Reception with the telephone.

- For more information about setting the ID number, see ▶<Remote RX>(P. 395) .

**3** Hang up the handset.

## LINKS

---

- ▶ **Checking Status and Log for Sent and Received Documents(P. 217)**
- ▶ **Various Receiving Methods(P. 212)**

## Useful Functions When Sending

---

2KUU-044

This section describes how to forward a fax again to a previously specified destination, how to send a fax after a phone call, and how to save a copy of a fax document.



▶ **Recalling Previously Used Settings for Sending (Recall Settings)(P. 208)**



▶ **Sending a Fax after a Phone Call (Manual Sending)(P. 210)**

# Recalling Previously Used Settings for Sending (Recall Settings)

2KUU-045



You can recall the destinations specified in the past. When you specify a previously used destination, the machine also sets the same fax settings such as density you used the last time you sent documents to that destination.

## IMPORTANT

- When <Restrict Resending from Log> is set to <On>, you cannot use this feature. ▶ **Disabling Use of Previously Used Destinations(P. 327)**
- Turning OFF the machine or setting <Restrict New Destinations> to <On> deletes the past destinations, and disables this feature. ▶ **Restricting New Destinations that Can Be Specified(P. 327)**
- The destinations in Manual Sending are not available for this feature. ▶ **Sending a Fax after a Phone Call (Manual Sending)(P. 210)**

## NOTE

- When you specify a destination using this feature, any destinations that you have already specified are deleted.

**1 Place the original(s).** ▶ **Placing Originals(P. 128)**

**2 Select <Fax> in the Home screen.** ▶ **Home Screen(P. 111)**

**3 Press** .

- If the destinations set by the previous user are still selected, this can cause transmission errors. Always reset the settings before sending.

**4 Select <Destination> ▶ <Recall Set.>.**

**5 Select the destination.**

- When you transmit to multiple destinations, only the address specified for the first transmission is displayed in the log, but all the destinations are specified.

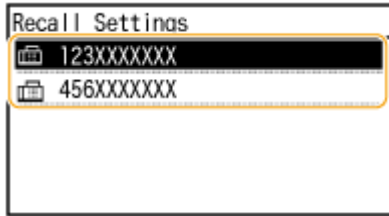

⇒ The selected destination and the fax settings used at the time are specified. You can also change the settings before sending.

### ■ To delete destinations

When you transmitted to multiple destinations, you can delete destinations as necessary.

- 1 Select <Destination> ► <Confirm/Edit>.
- 2 Select a destination you want to delete.
  - If you specified Group Dial, "XX destination(s)" is displayed. Selecting <Number of Destinations> displays destinations registered in the group.
- 3 Select <Remove> ► <Yes>.

## 6 Specify the scanning settings as necessary. ▶ Basic Operations for Sending Faxes(P. 195)

### 7 Press .

⇒ Scanning of the original starts.

- If you want to cancel, select <Cancel> ► <Yes>. ▶ Canceling Sending Faxes(P. 202)

### ■ When placing originals in the feeder in step 1

When scanning is complete, the faxes are sent.

### ■ When placing originals on the platen glass in step 1

When scanning is complete, follow the procedure below.

- 1 Select the original size.
  - When there is only one page to be scanned, proceed to step 3.
- 2 Place the next original on the platen glass, and press .
  - Repeat this step until you finish scanning all of the pages.
- 3 Select <Start TX>.

⇒ The faxes are sent.

## LINKS

▶ Basic Operations for Sending Faxes(P. 195)



## Sending a Fax after a Phone Call (Manual Sending)

2KUU-046



You can send faxes manually at the end of a phone conversation. When you hear a beep over the phone, it means the recipient is trying to receive your faxes. Press  to send your faxes.

### NOTE

- You need to connect your telephone to the machine beforehand.

### 1 Place the original(s). ▶ [Placing Originals\(P. 128\)](#)

- The machine cannot automatically scan both sides of the originals in Manual Sending.

### 2 Select <Fax> in the Home screen. ▶ [Home Screen\(P. 111\)](#)

### 3 Press .

- If the destinations set by the previous user are still selected, this can cause transmission errors. Always reset the settings before sending.

### 4 Specify the scanning settings as necessary. ▶ [Basic Operations for Sending Faxes\(P. 195\)](#)

### 5 Dial the recipient's fax number.

### 6 Ask the recipient to set their fax machine to receive your faxes.

- If you hear a beep, proceed to step 7.

### 7 Press .

▢ Scanning of the original starts.

- If you want to cancel, select <Cancel> ▶ <Yes>. ▶ [Canceling Sending Faxes\(P. 202\)](#)

### 8 Hang up the handset.

## LINKS

▶ [Basic Operations for Sending Faxes\(P. 195\)](#)

▶ **Canceling Sending Faxes(P. 202)**

▶ **Checking Status and Log for Sent and Received Documents(P. 217)**

## Various Receiving Methods

---

2KUU-047

You can store received faxes in the machine's memory without printing them. You can reduce fax paper waste by checking the detailed information of fax documents and only printing necessary documents.

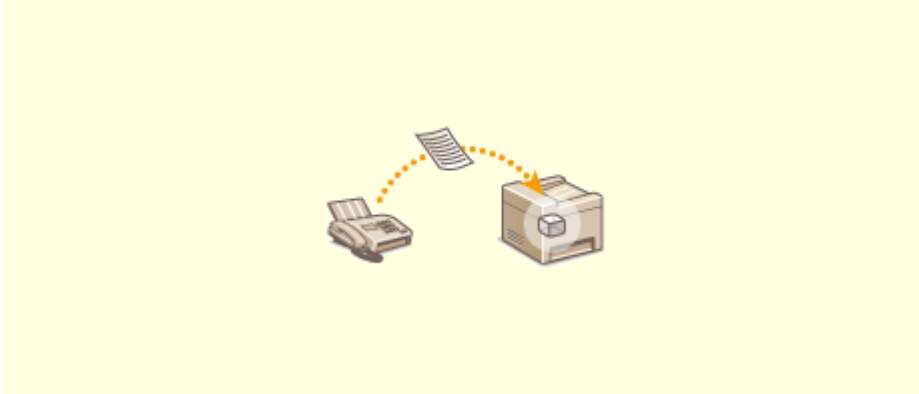

▶ **Saving Received Documents into the Machine (Memory Reception)(P. 213)**

# Saving Received Documents into the Machine (Memory Reception)

2KUU-0A6





You can store received faxes into memory of the machine, and then print them later. This feature can prevent unauthorized persons from seeing confidential documents unintentionally.

- ▶ **Storing Documents into Memory(P. 213)**
- ▶ **Printing Documents in Memory(P. 213)**
- ▶ **Checking/Forwarding/Deleting Documents in Memory(P. 214)**

## Storing Documents into Memory

To store received documents into memory, set <Memory Lock Settings> to <On>. You can also specify optional settings such as a time setting that specifies a period of time during the day in which received documents are stored in memory.

 <Menu> ▶ <Fax Settings> ▶ <RX Function Settings> ▶ <Memory Lock Settings> ▶ <On> ▶ Specify each setting ▶ <Apply> ▶ 

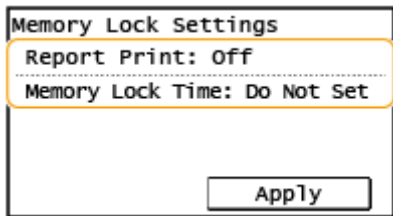

**<Report Print>**

Enables you to print RX Result reports every time documents are stored into memory. To print reports, select <On>. You also need to set <RX Result Report> to <On>. ▶ **RX Result Report (Touch Panel Model)(P. 456)**

**<Memory Lock Time>**

Specify a period of time during the day in which received documents are stored in memory. If you do not set a period of time, the machine stores every document into memory when Memory Reception is turned on.

## Printing Documents in Memory

To print received documents in memory, set <Memory Lock Settings> to <Off>. All the documents in memory are printed.

**NOTE**

- You cannot select a specific document for printing.
- If a time for the feature to deactivate has been specified, the documents are automatically printed at the specified time.

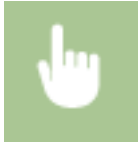

<Menu> ▶ <Fax Settings> ▶ <RX Function Settings> ▶ <Memory Lock Settings> ▶ <Off> ▶

## Checking/Forwarding/Deleting Documents in Memory

You can check an outline of each document stored in memory, including sender fax numbers and number of pages sent. You can also select and forward a document stored in memory, and delete an unnecessary document, if any.

**1** Press

**2** Select <RX Job>.

**3** Select <Job Status> and select the document whose status you want to check.

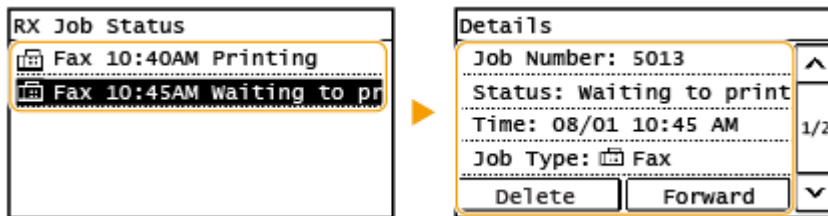

⇒ Displays detailed information about the document.

- To forward the document, select <Forward>, and specify the appropriate destination.
- To delete the document, select <Delete> ▶ <Yes>.

## TIPS

- You can preview received documents using the Remote UI. [▶ Checking the Status and Logs\(P. 338\)](#)

## LINKS

- ▶ [Receiving Faxes\(P. 203\)](#)
- ▶ [Checking Status and Log for Sent and Received Documents\(P. 217\)](#)

# Forwarding the Received Documents Automatically

2KUU-049

The machine can forward all the received documents to specified destinations. Even if you are out of the office, you can receive fax information anytime, anywhere.

- ▶ **Specifying Settings for Documents to be Forwarded Automatically(P. 215)**
- ▶ **Printing Documents to be Forwarded(P. 215)**
- ▶ **Printing/Resending/Deleting Documents that Failed to be Forwarded(P. 215)**

## Specifying Settings for Documents to be Forwarded Automatically

While the Forwarding feature is activated, all the documents to be received are automatically forwarded.



<Menu> ▶ <Fax Settings> ▶ <Forwarding Settings> ▶ <Enable Forwarding Settings> ▶ <On>  
▶ Select the forwarding destination from the Address Book ▶

## Printing Documents to be Forwarded

If you want to check the documents to be forwarded for yourself, you can set the machine to print the documents whenever they are forwarded, or to print only the documents that failed to be forwarded.



<Menu> ▶ <Fax Settings> ▶ <Forwarding Settings> ▶ <Print Images> ▶ Select <On> or <Only When Error Occurs> ▶

## Printing/Resending/Deleting Documents that Failed to be Forwarded

You can store documents that failed to be forwarded in memory, and print, resend, or delete them later.

### ■ Storing Documents that Failed to be Forwarded in Memory



<Menu> ▶ <Fax Settings> ▶ <Forwarding Settings> ▶ <Store Images in Memory> ▶ <Only When Error Occurs> ▶

### ■ Printing/Resending/Deleting Documents Stored in Memory

**1** Press .

**2** Select <Fax Forwarding Errors>.

**3** Select the document you want to print/resend/delete.

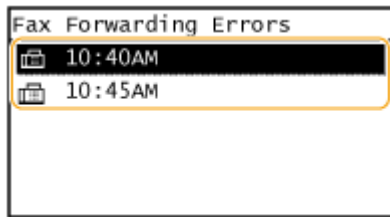

▣ Displays detailed information about the document.

- To print the document, select <Print/Fwd> ► <Print> ► <Yes>.
- To resend the document, select <Print/Fwd> ► <Forward>, and specify the appropriate destination.
- To delete the document, select <Delete> ► <Yes>.

## LINKS

---

▶ **Receiving Faxes(P. 203)**

▶ **Checking Status and Log for Sent and Received Documents(P. 217)**

# Checking Status and Log for Sent and Received Documents

2KUU-04A

The statuses and communication logs for sent and received fax documents can be checked separately for sending and receiving.

## IMPORTANT

- When <Display Job Log> is set to <Off>, you cannot check the communication logs. ▶<Display Job Log>(P. 425)

## NOTE

- The destinations in Manual Sending cannot be checked because they are not displayed.

1 Press .

2 Select <TX Job> or <RX Job>.

3 Check the statuses and communication logs for sent and received documents.

### ■ To check the statuses for sent and received documents

- 1 Select <Job Status> and select the document whose status you want to check.

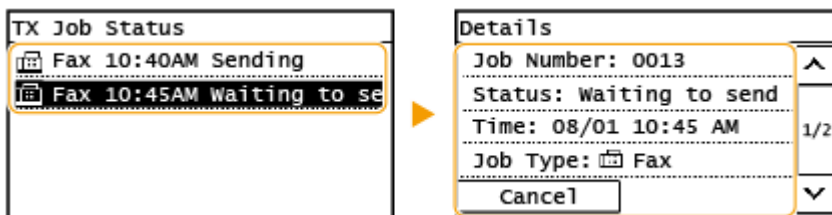

► Displays detailed information about the document.

- If you specified multiple destinations, the number of specified destinations is displayed on the screen. To check the details of specified multiple destinations, select <Number of Destinations>.

### ■ To check the communication logs for sent and received documents

- 1 Select <Job Log> and select the document whose status you want to check.
  - <OK> is displayed when a document was sent or received successfully, and <Error> is displayed when a document failed to be sent or received because it was canceled or there was some error.



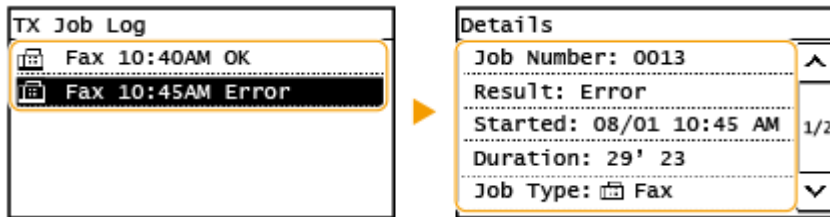

▢▢▢▢ Displays detailed information about the document.

## NOTE:

If the <Result> column shows a three-digit number

- This number represents an error code. [▶Countermeasures for Each Error Code\(P. 504\)](#)

## LINKS

---

- ▶ [Basic Operations for Sending Faxes\(P. 195\)](#)
- ▶ [Canceling Sending Faxes\(P. 202\)](#)
- ▶ [Receiving Faxes\(P. 203\)](#)
- ▶ [Printing Reports and Lists\(P. 455\)](#)

## Sending Faxes from Your Computer (PC Fax)

2KUU-04C

You can send fax documents created on your computer application directly from your computer. This feature eliminates the need to print documents for faxing and saves paper. You need to specify the basic fax settings ( [▶ Configuring Initial Settings for Fax Functions\(P. 70\)](#) ) and install the fax driver on your computer. For more information about how to install the fax driver, see the manuals for the relevant drivers on the online manual website.



### ▶ Sending PC Faxes(P. 220)

## NOTE

- Depending on the operating system and the version of the fax driver you are using, the fax driver screens in this manual may differ from your screens.

### About the Fax Driver Help

- Clicking [Help] on the fax driver screen displays the Help screen. On this screen you can see information that is not in the User's Guide, including information about driver features such as registering frequently used settings and how to set up those features.

# Sending PC Faxes

2KUU-04E

## IMPORTANT

- When <Allow Fax Driver TX> is set to <Off> on the machine, you cannot send faxes from computers.  **Restricting Fax Sending from a Computer(P. 329)**

### 1 Open a document in an application and display the print dialog box.

- How to display the print dialog box differs for each application. For more information, see the instruction manual for the application you are using.

### 2 Select the fax driver for this machine, and click [Print].

### 3 Specify the destination.

#### ■To specify only one destination

- Click the [Enter Destination] tab.
- Set the communication mode and fax number (or URI).

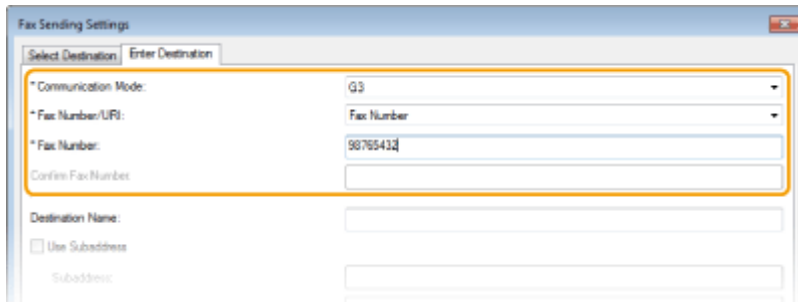

Fax Sending Settings

Select Destination Enter Destination

\* Communication Mode: G3

\* Fax Number/URI: Fax Number

\* Fax Number: 987654321

Confirm Fax Number:

Destination Name:

Use Subaddress

Subaddress:

#### ■To specify multiple destinations at once

- Click the [Select Destination] tab.
- Click [Add Destination].
- Set the communication mode and fax number (or URI), and click [OK].

**4** Repeat steps 2 and 3 to add concurrent destinations.

- You can also add a destination by clicking [Add Next Destination] in step 3.

- If you need to specify a number to dial an outside line, select [Detailed Settings] ► [Add Outside Dialing Prefix to G3/IP Fax Number] and enter the number as an external line connection number. The specified number is added to the beginning of the fax number when the machine dials.
- To make it easier to specify destinations using the Address Book.
- Selecting [Store Sent Fax Information and Image] enables you to store the logs for sending documents and check detailed information of a sent document along with its image, including destinations and number of pages. For more information, click [Help] on the fax driver screen.

**NOTE:**

- When the [Confirm Fax Number] or [Confirm URI] field is active, also enter the appropriate number in the field. The setting of whether to confirm entered numbers can be changed in the fax driver screen. For more information, click [Help] on the fax driver screen.

**4** Click [Send] to send the document.

# Printing

<b>Printing</b> .....	223
<b>Printing from a Computer</b> .....	224
Canceling Prints .....	226
Checking the Printing Status and Log .....	228

# Printing

You can print documents on your computer by using the printer driver.

## ■ Printing from a Computer

You can print a document made on your computer by using the printer driver.

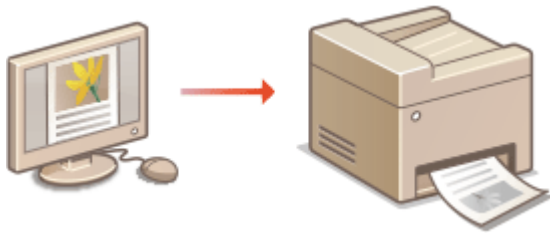

▶ **Printing from a Computer(P. 224)**

### Printing from Mobile Devices

- Linking mobile devices such as smartphones or tablets to this machine provides a quick and easy way to print photos and web pages. The machine also supports Google Cloud Print™.

▶ **Linking with Mobile Devices(P. 266)**

▶ **Using Google Cloud Print(P. 286)**

### Printing silently

If you mind the printing noise, you can reduce the noise by specifying the quiet mode. Note that If you print in the quiet mode, printing becomes slower.

# Printing from a Computer

2KUU-04H

You can print a document made with an application on your computer by using the printer driver. There are useful settings on the printer driver, such as enlarging/reducing and 2-sided printing, that enable you to print your documents in various ways. Before you can use this function, you need to complete some procedures, such as installing the printer driver on your computer. For more information, see the manuals for the relevant drivers on the online manual website.

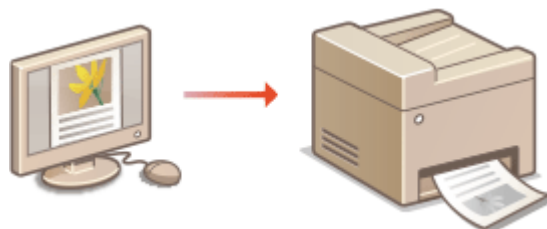

▶ **About the Printer Driver Help(P. 224)**

▶ **Basic Printing Operations(P. 224)**

## About the Printer Driver Help

Clicking [Help] on the printer driver screen displays the Help screen. On this screen, you can see the detailed descriptions that are not in the User's Guide.

## Basic Printing Operations

This section describes how to print a document on your computer by using the printer driver.

### NOTE

#### Paper settings on the machine

- Normally, it is necessary to specify the paper size and type for the paper loaded in each paper source before proceeding to printing.

- 1 Open a document in an application and display the print dialog box.**
- 2 Select the printer driver for this machine, and click [Preferences] or [Properties].**
- 3 Specify the print settings as necessary, and click [OK].**
  - Switch the tab according to the settings.



#### 4 Click [Print] or [OK].

⇒ Printing starts.

- If you want to cancel printing, see [▶Canceling Prints\(P. 226\)](#) .

#### LINKS

- ▶[Checking the Printing Status and Log\(P. 228\)](#)



# Canceling Prints

2KUU-04J

You can cancel printing from your computer or on the operation panel of the machine.

- ▶ From a Computer(P. 226)
- ▶ From the Operation Panel(P. 227)

## From a Computer

You can cancel printing from the printer icon displayed on the system tray on the desktop.

### 1 Double-click the printer icon.



#### NOTE:

When the printer icon is not displayed

- Open the printer folder ( ▶ **Displaying the Printer Folder(P. 556)** ), right-click the printer driver icon for this machine, and click [See what's printing] (or double-click the icon of the printer driver for this machine).

### 2 Select the document you want to cancel, and click [Document] ▶ [Cancel].

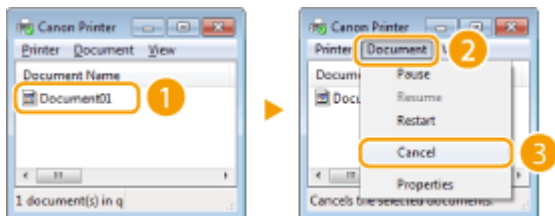

### 3 Click [Yes].

⇒ Printing of the selected document is canceled.

## NOTE

- Several pages may be output after you cancel printing.

## TIPS

### Canceling from the Remote UI



- You can cancel printing from the [Job Status] page on the Remote UI: ▶ **Checking Current Status of Print Documents(P. 338)**

### Canceling from an application

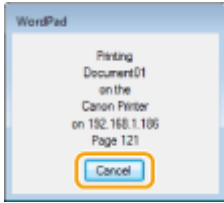
- On some applications, a screen like shown below appears. You can cancel printing by clicking [Cancel].



## From the Operation Panel

Cancel printing using  or .

### ■ Press to Cancel

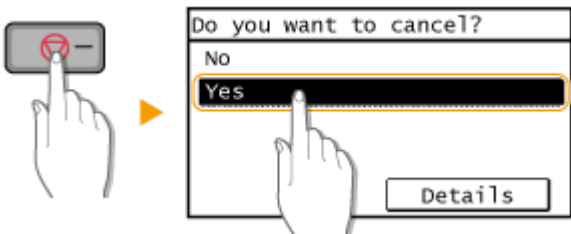

### If the Screen Displays a List of Documents When is Pressed

Select the document you want to cancel, and select <Yes>.

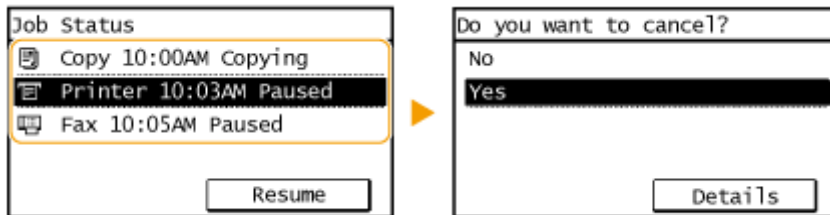

### ■ Check the Print Job Status Before Canceling



 ▶ <Copy/Print Job> ▶ <Job Status> ▶ Select the document in the <Copy/Print Job Status> screen ▶ <Cancel> ▶ <Yes>

## NOTE

- Several pages may be output after you cancel printing.

## LINKS

- ▶ Basic Printing Operations(P. 224)
- ▶ Checking the Printing Status and Log(P. 228)

## Checking the Printing Status and Log

2KUU-04K

You can check the current print statuses and the logs for printed documents.

### IMPORTANT

- When <Display Job Log> is set to <Off>, you cannot check the print logs. **<Display Job Log>(P. 425)**

#### Useful in the Following Cases

- When your documents are not printed for a long time, you may want to see the waiting list of the documents waiting to be printed.
- When you cannot find your printouts that you thought had been printed, you may want to see whether an error has occurred.

**1** Press .

**2** Select <Copy/Print Job>.

**3** Check the print statuses and logs.

#### ■ To check the print statuses

- 1** Select <Job Status> and select the document whose status you want to check.

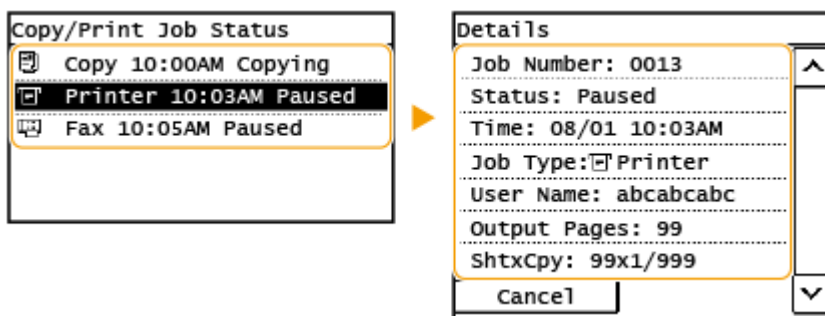

▢▢▢▢ Displays detailed information about the document.

#### ■ To check the print logs

- 1** Select <Print Job Log> and select the document whose log you want to check.
- <OK> is displayed when a document was printed successfully, and <Error> is displayed when a document failed to be printed because it was canceled or there was some error.

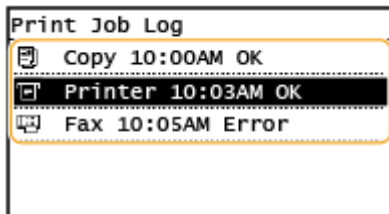

▢ Displays detailed information about the document.

- The displayed document name or user name may not reflect the actual document or user name.

## NOTE:

When a three-digit number is shown in the case of <Error>

- This number represents an error code. ▶ **Countermeasures for Each Error Code(P. 504)**

## LINKS

---

▶ **Basic Printing Operations(P. 224)**

▶ **Canceling Prints(P. 226)**

# Scanning

<b>Scanning</b> .....	231
<b>Basic Operations for Scanning Originals</b> .....	233
Scanning and Saving to a Computer .....	234
Scanning Using the Shortcut Key .....	236
Sending Data by E-Mail/Saving Data to a Shared Folder .....	239
Canceling Sending Documents .....	247
Checking Status and Log for Scanned Originals .....	249
<b>Scanning Clearly</b> .....	251
Adjusting Image Quality .....	252
Adjusting Density .....	253
Adjusting Sharpness When Scanning (Sharpness) .....	254
<b>Useful Scanning Functions</b> .....	255
Adjusting Balance between File Size and Image Quality .....	256
Recalling Previously Used Settings for Sending/Saving (Recall Settings) .....	257
Specifying E-Mail Settings .....	259
<b>Using Your Computer to Scan (Remote Scan)</b> .....	261
Scanning Documents from an Application .....	262
Using ScanGear MF .....	264

# Scanning

2KUU-04L

You can scan original documents by using the operation panel of the machine or an application on a computer. Whichever way you use, the scanned originals are converted into electronic file formats such as PDFs. Use the scan function to convert large-volume paper documents into files so that you can organize them easily.

## NOTE

- To use this machine as a scanner, you must complete preparations in advance, including installation of software to a computer. For more information, see the manuals for the relevant drivers or software on the online manual website. To connect the machine to your computer via a network, you must register the machine to the installed software. ▶ **Preparing to Use the Machine as a Scanner(P. 77)**
- Depending on the operating system and the version of the scanner driver or applications you are using, the screens in this manual may differ from your screens.

### ■ Using Basic Operations

You can scan and save originals to your computer by using the operation panel of the machine. You can also send originals as e-mail attachments.

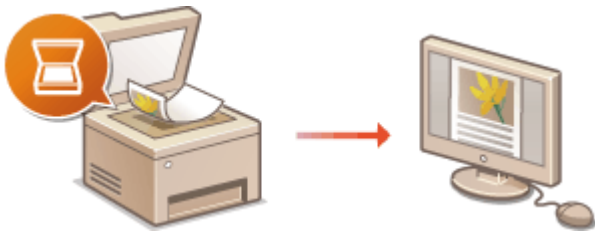

- ▶ **Basic Operations for Scanning Originals(P. 233)**
- ▶ **Canceling Sending Documents(P. 247)**
- ▶ **Checking Status and Log for Scanned Originals(P. 249)**

### ■ Enhancing Quality

You can find instructions on how to resolve problems such as "blurry photos" or "text unreadable due to too deep color of the paper."

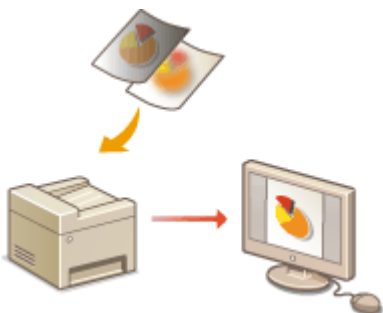

- ▶ **Scanning Clearly(P. 251)**

### ■ Efficiently, Reliably

You can find instructions on how to enhance efficiency when sending data and descriptions of useful settings.

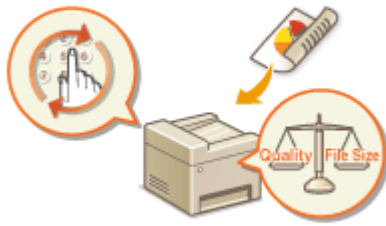
**▶ Useful Scanning Functions(P. 255)****■ Scanning from a Computer**

You can scan originals placed on the machine from a computer. The scanned originals are saved to the computer. You can scan using MF Scan Utility (included with the machine), or with other applications such as an image-processing or word-processing application.

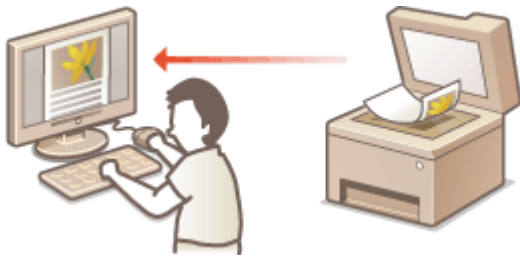
**▶ Using Your Computer to Scan (Remote Scan)(P. 261)****Scanning from Mobile Devices**

- Linking mobile devices such as smartphones or tablets to this machine provides a quick and easy way to scan originals set on this machine. **▶ Linking with Mobile Devices(P. 266)**

## Basic Operations for Scanning Originals

---

2KUU-04S

This section describes the basic procedures for scanning originals.

### ■ Scanning



▶ Scanning and Saving to a Computer(P. 234)



▶ Scanning Using the Shortcut Key(P. 236)



▶ Sending Data by E-Mail/Saving Data to a Shared Folder(P. 239)

### ■ Operating Jobs

▶ Canceling Sending Documents(P. 247)

▶ Checking Status and Log for Scanned Originals(P. 249)



# Scanning and Saving to a Computer

2KUU-04U

The sequence of "scanning an original and saving it to a computer" can only be done when scanning from the machine. Scan while specifying what computer originals will be saved to; whether to scan originals in color or black and white; whether to save originals as PDFs or JPEGs; and other settings. Incidentally, if you want to specify a computer connected to the network as the destination, you must register the machine with the computer in advance ( [▶Preparing to Use the Machine as a Scanner\(P. 77\)](#) ).

## 1 Place the original(s). [▶Placing Originals\(P. 128\)](#)

## 2 Display the <Scan> screen. [▶Home Screen\(P. 111\)](#)

### Touch Panel Model

Select <Scan> in the Home screen.

### 5 Lines LCD Model

Press  (COPY/SCAN).

## 3 Select <Computer>.

- If only a computer connected to the machine via USB is used, proceed to step 5.

## 4 Select the destination computer.

## 5 Select the scan type.

- The scan types and settings that are displayed can be confirmed and changed by using MF Scan Utility. For more information, click [Instructions] on MF Scan Utility.

### NOTE:

- If you are a macOS user, see the manuals for the relevant drivers or software on the online manual website.

## 6 Press ( ).

▢ Scanning of the original starts.

- If you want to cancel, select <Cancel>  <Yes>. [▶Canceling Sending Documents\(P. 247\)](#)

### IMPORTANT:

- You cannot scan while the ScanGear MF is displayed. Close the screen before scanning.

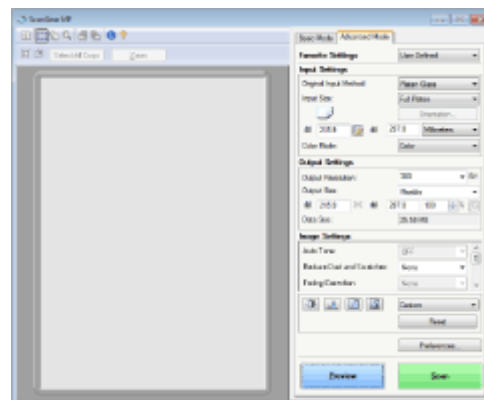

### ■ When placing originals in the feeder in step 1

When scanning is complete, the save destination folder is displayed on the computer.

### ■ When placing originals on the platen glass in step 1

When scanning is complete, follow the procedure below (when the file format is PDF).

- 1 If there are additional pages of originals to be scanned, place the next original on the platen glass, and press .
  - Repeat this step until you finish scanning all of the pages.
  - When there is only one page to be scanned, proceed to the next step.
- 2 Select <Finish Scan>/<Finish Scanning>.
  - ▣ The save destination folder is displayed on the computer.

## NOTE

### About the save destination folder

- By default, the scanned data is saved to the [My Documents] folder. A subfolder named with the scanning date is created, and the data is saved to that folder.
- You can change the save destination from the MF Scan Utility. For more information, click [Instructions] on MF Scan Utility.

### Scan from the machine more easily

- If you have regularly used preferences, such as scanning in color or black and white, or a pre-determined computer where scanned originals will be saved, specifying these settings each time you scan can be troublesome. Register these settings in the shortcut key so that you can scan with one press of a key. ▶ **Scanning Using the Shortcut Key(P. 236)**

## Scanning Using the Shortcut Key

2KUU-04W

After placing an original on the machine, use the short cut key and scanning starts. The type of scan (color or black and white), the save destination for the original, and other settings can be registered to the menu items, and originals can be scanned using those settings. This section describes how to register settings in the menu item and scan with it.

- ▶ **Registering Your Settings in the Shortcut Key(P. 236)**
- ▶ **Using the Shortcut Key(P. 237)**

### Registering Your Settings in the Shortcut Key

Register the computer that scanned images are saved in and the type of scan to the shortcut key.

#### 1 Display the <Menu> screen. ▶ Home Screen(P. 111)

##### Touch Panel Model

Select <Menu> in the Home screen.

##### 5 Lines LCD Model

Press .

#### 2 Select <Scan Settings>.

#### 3 Select <Shortcut Key Settings> ▶ <Register>.

#### 4 Select the shortcut key to which you want to register settings.

#### 5 Select the type of connection that is used between the machine and computer.

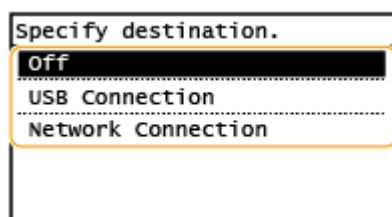

##### <Off>

Select this setting to erase registered settings.

##### <USB Connection>

Select this setting if the machine and computer are connected via USB.

##### <Network Connection>

Select this setting if the machine and computer are connected via a network.

#### 6 Select the destination computer.

- If you selected <USB Connection> in step 5, proceed to step 7.

## 7 Select the scan type.

- The scan types and settings that are displayed can be confirmed and changed by using MF Scan Utility. For more information, click [Instructions] on MF Scan Utility.

### NOTE:

- If you are a macOS user, see the manuals for the relevant drivers or software on the online manual website.

## ■ Checking the Registered Settings



<Menu> (  ) ▶ <Scan Settings> ▶ <Shortcut Key Settings> ▶ <Confirm Destination> ▶ Select shortcut key

## Using the Shortcut Key

### 1 Place the original(s). ▶ Placing Originals(P. 128)

### 2 Select the shortcut key.

#### Touch Panel Model

Select <Scan -> PC1> or <Scan -> PC2> in the Home screen. ▶ Home Screen(P. 111)

#### 5 Lines LCD Model

Press .

- To check the settings registered in the key, see ▶ Checking the Registered Settings(P. 237) .
- Scanning starts.
- If you want to cancel, select <Cancel> ▶ <Yes>. ▶ Canceling Sending Documents(P. 247)

### IMPORTANT:

You cannot scan while the ScanGear MF is displayed. Close the screen before scanning.

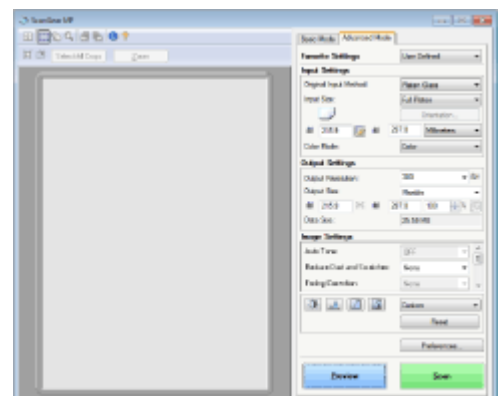

**■When placing originals in the feeder in step 1**

When scanning is complete, the save destination folder is displayed on the computer.

**■When placing originals on the platen glass in step 1**

When scanning is complete, follow the procedure below (when the file format is PDF).

- 1** If there are additional pages of originals to be scanned, place the next original on the platen glass, and press .
  - Repeat this step until you finish scanning all of the pages.
  - When there is only one page to be scanned, proceed to the next step.
- 2** Select <Finish Scan>/<Finish Scanning>.
  - ▢ The save destination folder is displayed on the computer.

## NOTE

### About the save destination folder

- By default, the scanned data is saved to the [My Documents] folder. A subfolder named with the scanning date is created, and the data is saved to that folder.
- You can change the save destination from the MF Scan Utility. For more information, click [Instructions] on MF Scan Utility.

# Sending Data by E-Mail/Saving Data to a Shared Folder

2KUU-04X

This section describes the procedures for scanning originals and sending the scanned data directly from the machine by attaching it to an e-mail or saving it to a shared folder.

## NOTE

- Before you can send the data directly by e-mail, you need to complete certain procedures, such as specifying the e-mail server settings. ▶ **Procedure for Setting to Send E-Mail(P. 78)**
- Before you can save the data to a shared folder, you need to complete certain procedures, such as specifying the location to save the scanned originals to. ▶ **Procedure for Setting a Shared Folder as a Save Location(P. 85)**

**1 Place the original(s).** ▶ **Placing Originals(P. 128)**

**2 Select <Scan> in the Home screen.** ▶ **Home Screen(P. 111)**

**3 Select <E-Mail> or <File>.**

**4 Specify the destination.**

- If you selected <File> in step 3, the Address Book screen is displayed. You can also specify the destination from coded dial numbers or one-touch dial numbers.

- ▶ Specifying from Address Book
- ▶ Specifying from Coded Dial Numbers
- ▶ Specifying from One-Touch
- ▶ Entering Destinations Directly (E-Mail Sending)

## Specifying from Address Book



The Address Book enables you to specify a destination by selecting from a list of registered destinations or by searching by name for destinations with recipient names.

## NOTE

- You need to register destinations in the Address Book before using this feature. ▶ **Registering Destinations(P. 161)**
- Register the shared folder address from a computer.
  - ▶ **Setting a Shared Folder as a Save Location(P. 86)**
  - ▶ **Registering Destinations from Remote UI(P. 347)**

## 1 Select <Destination> ▶ <Specify from Address Book>.

- If the <Type> screen appears, select <To>, <Cc>, or <Bcc> as a destination type.

## 2 Select an index. ▶ Index(P. 161)



## 3 Select a destination.

### NOTE:

If you want to specify multiple destinations (e-mail)

- Repeat steps 1 to 3.

## TIPS

- If a destination is selected from <Addr. Book> in the Home screen, settings for e-mail sending or file saving can be made while the selected destination remains specified.

## Specifying from Coded Dial Numbers



Three-digit numbers (coded dial numbers) are assigned to addresses in the Address Book. You can specify an address simply by entering its coded dial number.

### NOTE

- To use coded dial numbers, the destination must be registered in the Address Book beforehand. ▶ **Registering Destinations(P. 161)**
- Register the shared folder address from a computer.
  - ▶ **Setting a Shared Folder as a Save Location(P. 86)**
  - ▶ **Registering Destinations from Remote UI(P. 347)**

## 1 Select <Destination> ▶ <Specify from Coded Dial>.

- If the <Type> screen appears, select <To>, <Cc>, or <Bcc> as a destination type.

## 2 Enter a three-digit number.

- If you have entered an incorrect value, use **C** to clear it.

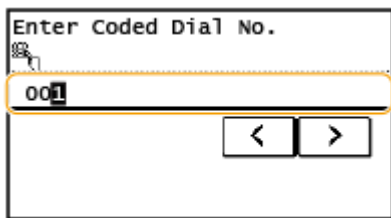

## NOTE:

### If a confirmation screen appears

- When <One-Touch/Coded Dial TX Confirmation> is set to <On>, a screen is displayed that shows the destination and the name for the number. (For Group Dial, the destination name and the number of destinations are shown.) Check the contents and if everything is correct, select <OK>. To specify a different destination, select <Cancel> and then re-enter the three-digit coded dial number. **▶ Displaying Destinations in Address Book(P. 327)**

### If you want to specify multiple destinations (e-mail)

- Repeat steps 1 to 2.

## Specifying from One-Touch



Specify a destination by selecting from a list registered to the one-touch buttons.

## NOTE

- You need to register destinations before using one-touch dialing. **▶ Registering Destinations in the Address Book(P. 163)**

**1** Select <Destination> ▶ <Specify from One-Touch>.

**2** Select a destination.

## NOTE:

### If a confirmation screen appears

- When <One-Touch/Coded Dial TX Confirmation> is set to <On>, a screen is displayed that shows the destination and destination name registered to the one-touch button. (For Group Dial, the group name and the number of destinations are shown). Check the contents and if everything is correct, select <OK>. To specify a different destination, select <Cancel> and then select the one-touch buttons again.

## TIPS



- If a destination is selected from any of <One-Touch 1> to <One-Touch 4> in the Home screen, settings for sending e-mail or saving files can be made while the selected destination remains specified.

## Entering Destinations Directly (E-Mail Sending)

For a destination that is not registered in the Address Book, specify it by entering an e-mail address.

### 1 Select <Destination> ▶ <Specify Using Numeric Keys>.

### 2 Enter the e-mail address, and select <Apply>.

- On how to enter text, see [▶ Entering Text\(P. 123\)](#) .

#### NOTE:

##### Specifying destinations from the transmission records

- You can also recall previously used destinations. [▶ Recalling Previously Used Settings for Sending/Saving \(Recall Settings\)\(P. 257\)](#)

##### Saving the data to a shared folder

- Only one destination can be specified.

### 5 When sending an e-mail, specify multiple destinations, including Cc/Bcc destinations, as necessary.

- Select <Destination>, and select the method for specifying destinations.

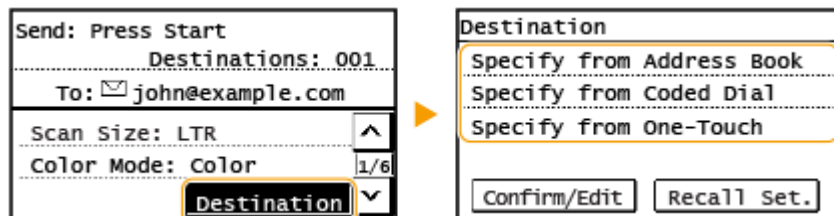

- <Cc> and <Bcc> addresses can only be selected using <Specify from Address Book>, <Specify from Coded Dial> or <Specify from One-Touch>.

#### ■ To delete destinations

If you specified multiple destinations, you can delete destinations as necessary.

### 1 Select <Destination> ▶ <Confirm/Edit>.

### 2 Select a destination you want to delete.

- If you specified Group Dial, "XX destination(s)" is displayed. Selecting <Number of Destinations> displays destinations registered in the group.

### 3 Select <Remove> ▶ <Yes>.

### 6 Specify the scanning settings as necessary.

- ▶ Specifying the Scanning Size of the Original
- ▶ Specifying the Color Mode
- ▶ Selecting a File Format
- ▶ Specifying Orientation of Your Original
- ▶ Scanning 2-Sided Originals

## Specifying the Scanning Size of the Original



You can specify the scanning size of your original.



<Scan Size> ▶ Select the original size

## Specifying the Color Mode



You can specify whether to scan documents in color or black and white.



<Color Mode> ▶ Select the color mode

## Selecting a File Format



You can select the file format to which originals are scanned from PDF/JPEG/TIFF. For PDF, you can select Compact PDF that reduces the data size.



<File Format> ▶ Select a file format

## NOTE

- If you select JPEG in <File Format> and try to scan an original from the platen glass, you can only scan one page. To scan a multiple-page original all at once, use the feeder. Each page of the original is saved as a separate file. If you select TIFF or PDF, you can scan multiple-page originals either from the platen glass or from the feeder.
- <PDF (Compact)> compress photos and illustrations on originals more than <PDF>. The file will be smaller, but the image quality of some originals or the number of originals that can be scanned at once may be lower.

## Specifying Orientation of Your Original



You can specify portrait or landscape orientation.



<Original Orientation> ▶ Select the original orientation

## Scanning 2-Sided Originals



The machine can automatically scan the front and back sides of originals in the feeder.

## IMPORTANT

- The machine cannot scan both sides of originals automatically when the originals are placed on the platen glass.



<2-Sided Original> ▶ Select <Book Type> or <Calendar Type>

<b>2-Sided Original</b>
off
Book Type
Calendar Type

### <Book Type>

Select for originals whose images on the front and back sides face the same direction.

**<Calendar Type>**

Select for originals whose images on the front and back sides face in opposite directions.

**NOTE:**

- For information about other scan settings, see **Scanning Clearly(P. 251)** or **Adjusting Balance between File Size and Image Quality(P. 256)** .
- For e-mail, you can specify the subject, message, reply-to address, and priority as necessary. **Specifying E-Mail Settings(P. 259)**

**7 Press .**

⇒ Scanning of the original starts.

- If you want to cancel, select <Cancel> ► <Yes>. **Canceling Sending Documents(P. 247)**

**■When placing originals in the feeder in step 1**

When scanning is complete, the sending/saving process starts.

**■When placing originals on the platen glass in step 1**

When scanning is complete, follow the procedure below (except if you selected JPEG as a file format).

- 1** If there are additional pages of originals to be scanned, place the next original on the platen glass, and press .
  - Repeat this step until you finish scanning all of the pages.
  - When there is only one page to be scanned, proceed to the next step.
- 2** Select <Start TX>.
 

⇒ The sending/saving process starts.

**NOTE:****File name of the sent document**

- The file name of a sent document is automatically assigned based on the following format: communication management number (four digits)\_sent date and time\_document number (three digits).file extension name.

**If an E-Mail Send Error Occurs**

Error notifications are sometimes sent to the e-mail address set to the machine. If you leave it as-is, it may result in an insufficient remaining capacity of mailbox depending on your mail server. It is recommended that you clear the mailbox periodically.

**■To clear the mailbox****IMPORTANT:**

- When the mailbox is cleared, all e-mail in the server mailbox is deleted. When you specify the e-mail account that you use usually, you should first check whether any e-mail in the mailbox needs to be kept.

- 1** Start the Remote UI and log in to System Manager Mode. **Starting Remote UI(P. 335)**
- 2** Click [Settings/Registration] on the Portal page. **Remote UI Screen(P. 336)**
- 3** Select [Network Settings] ► [E-Mail Settings].



- 4 Click [Clear] in [Clear Mail Box].
- 5 Read the message that is displayed, and click [OK].
  - ▣ E-mail is deleted from the mailbox.

## TIPS

- If you always want to scan with the same settings:  **Changing the Default Settings for Functions(P. 154)**

## Canceling Sending Documents

2KUU-04Y

If you want to cancel sending documents immediately after pressing , select <Cancel> on the display or press . You can also cancel sending documents after checking the sending status.

### ■ Select <Cancel> to cancel

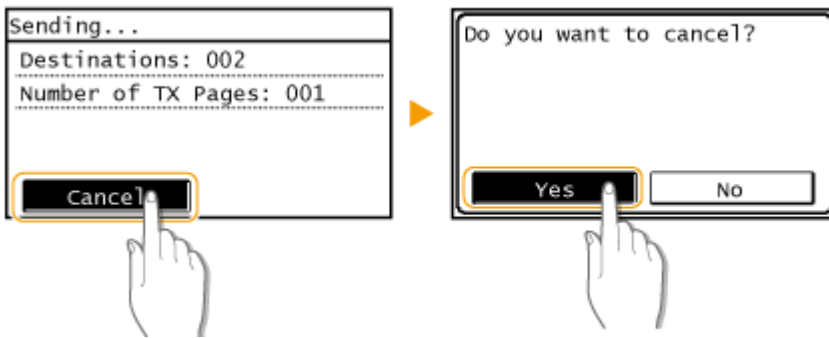

### ■ Press to cancel

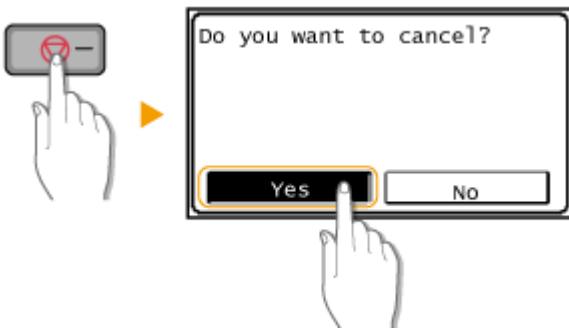

### If the screen displays a list of documents when is pressed

Originals have been scanned and are waiting to be processed. Select the document to cancel, and select <Yes>.

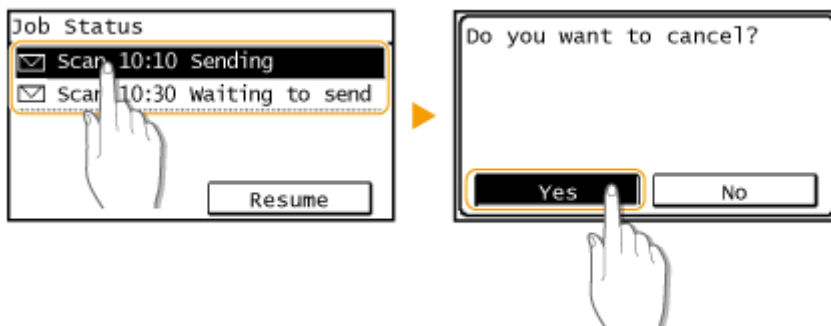

■ Check the transmission status before canceling

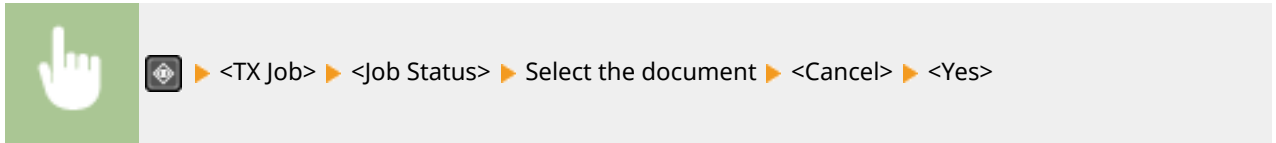

LINKS

---

- ▶ **Basic Operations for Scanning Originals(P. 233)**
- ▶ **Checking Status and Log for Scanned Originals(P. 249)**

# Checking Status and Log for Scanned Originals

2KUU-050

You can check the status and log for scanned originals sent directly from the machine.

## IMPORTANT

- When <Display Job Log> is set to <Off>, you cannot check the logs for sent documents. ▶<Display Job Log>(P. 425)

1 Press .

2 Select <TX Job>.

3 Check the statuses and logs for sent documents.

### ■To check the statuses for sent documents

- 1 Select <Job Status> and select the document whose status you want to check.

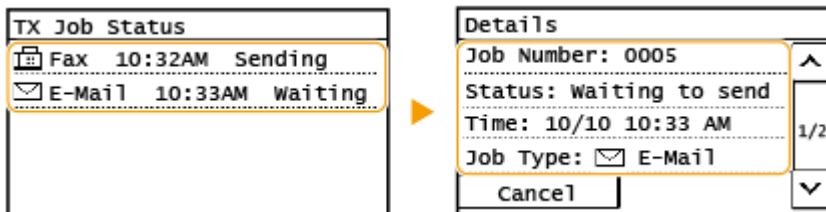

⇒ Displays detailed information about the document.

- If you specified multiple destinations, the number of specified destinations is displayed on the screen. To check the details of specified multiple destinations, select <Destination>.

### ■To check the logs for sent documents

- 1 Select <Job Log> and select the document whose log you want to check.
- <OK> is displayed when a document was sent successfully, and <Error> is displayed when a document failed to be sent because it was canceled or there was some error.

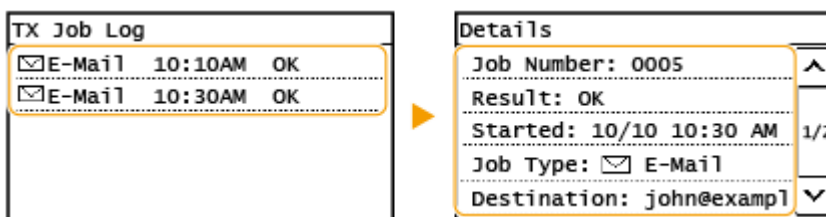

⇒ Displays detailed information about the document.

## NOTE:

When a three-digit number is shown in the case of <Error>



- This number represents an error code. **▶Countermeasures for Each Error Code(P. 504)**

## LINKS

---

- ▶Basic Operations for Scanning Originals(P. 233)**
- ▶Canceling Sending Documents(P. 247)**
- ▶Printing Reports and Lists(P. 455)**

## Scanning Clearly

---

2KUU-051

When creating files for brochures that contain many pictures or reports written in pencil, you can adjust density and brightness to achieve clearer image quality.



▶ Adjusting Image Quality(P. 252)



▶ Adjusting Density(P. 253)

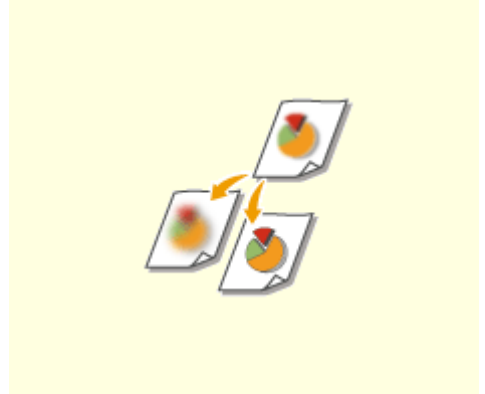

▶ Adjusting Sharpness When Scanning (Sharpness)(P. 254)

## Adjusting Image Quality

---

2KUU-052



You can select the image quality for the scan depending on the original type, such as text-only originals, originals with charts and graphs, or magazine photos.



<Scan> ▶ Specify destinations in <E-Mail> or <File> ▶ <Original Type> ▶ Select the original type

### LINKS

---

▶ **Basic Operations for Scanning Originals(P. 233)**

## Adjusting Density

---

2KUU-053



You can adjust the density of the scan if the text or images in a original are too light or dark.



<Scan> ▶ Specify destinations in <E-Mail> or <File> ▶ <Density> ▶ Adjust the density ▶ <Apply>

### LINKS

---

- ▶ **Basic Operations for Scanning Originals(P. 233)**
- ▶ **Adjusting Sharpness When Scanning (Sharpness)(P. 254)**

## Adjusting Sharpness When Scanning (Sharpness)

2KUU-054



You can adjust the sharpness of the image. Increase the sharpness to sharpen blurred text and lines, or decrease the sharpness to improve the appearance of magazine photos.



<Scan> ► Specify destinations in <E-Mail> or <File> ► <Sharpness> ► Adjust the sharpness ► <Apply>

**Example:** If you want to sharpen text and lines written in pencil



**Example:** If you want to improve the appearance of magazine photos

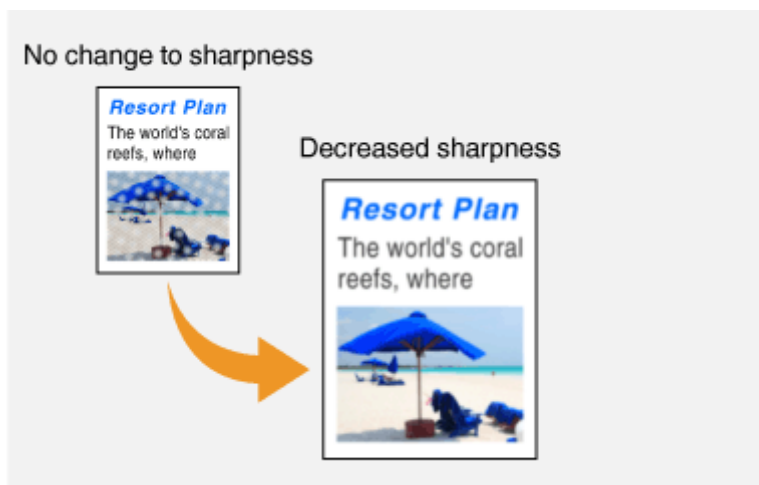

### LINKS

- ◉ Basic Operations for Scanning Originals(P. 233)
- ◉ Adjusting Density(P. 253)

## Useful Scanning Functions

---

2KUU-055

The machine is equipped with useful functions such as those that can create secure PDF files to prevent them from being tampered with, and that can send data again to previously specified destinations.



▶ **Adjusting Balance between File Size and Image Quality(P. 256)**



▶ **Recalling Previously Used Settings for Sending/Saving (Recall Settings)(P. 257)**



▶ **Specifying E-Mail Settings(P. 259)**

## Adjusting Balance between File Size and Image Quality

---

2KUU-056



You can specify the file compression ratio when converting scanned originals into the JPEG format. <Small: Memory Priority> makes the compression ratio higher than normal to create smaller files with lower image quality. On the other hand, <Large: Image Quality Priority> makes the compression ratio lower than normal larger files with higher image quality.



<Scan> ▶ Specify destinations in <E-Mail> or <File> ▶ <Data Size> ▶ Specify the setting

### LINKS

---

▶ **Basic Operations for Scanning Originals(P. 233)**

# Recalling Previously Used Settings for Sending/Saving (Recall Settings)

2KUU-057



You can select a destination from among the past destinations. When you specify a previously used destination, the machine also sets the same scan settings such as density you used the last time you sent documents to that destination.

## IMPORTANT

- When <Restrict Resending from Log> is set to <On>, you cannot use this feature. **▶Disabling Use of Previously Used Destinations(P. 327)**
- Turning OFF the machine or setting <Restrict New Destinations> to <On> deletes the past destinations, and disables this feature. **▶Restricting New Destinations that Can Be Specified(P. 327)**

## NOTE

- When you specify a destination using this feature, any destinations that you have already specified are deleted.

**1 Place the original(s).** **▶Placing Originals(P. 128)**

**2 Select <Scan> in the Home screen.** **▶Home Screen(P. 111)**

**3 Select <E-Mail> or <File>.**

**4 Select <Destination> ▶ <Recall Set.>.**

**5 Select the destination.**

- When you transmit to multiple destinations, only the address specified for the first transmission is displayed in the log, but all the destinations are specified.

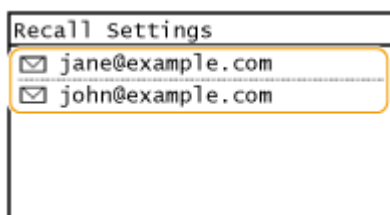

- ▶ The selected destination and its scan settings are specified. You can also change the settings before sending.



### ■ To delete destinations (e-mail)

If you specified multiple destinations, you can delete destinations as necessary.

- 1 Select <Destination> ► <Confirm/Edit>.
- 2 Select a destination you want to delete.
  - If you specified Group Dial, "XX destination(s)" is displayed. Selecting <Number of Destinations> displays destinations registered in the group.
- 3 Select <Remove> ► <Yes>.

## 6 Press .

⇒ Scanning of the original starts.

- If you want to cancel, select <Cancel> ► <Yes>. **▶ Canceling Sending Documents(P. 247)**

### ■ When placing originals in the feeder in step 1

When scanning is complete, the sending/saving process starts.

### ■ When placing originals on the platen glass in step 1

When scanning is complete, follow the procedure below (except if you selected JPEG as a file format).

- 1 If there are additional pages of originals to be scanned, place the next original on the platen glass, and press .
  - Repeat this step until you finish scanning all of the pages.
  - When there is only one page to be scanned, proceed to the next step.
- 2 Select <Start TX>.
 

⇒ The sending/saving process starts.

## LINKS

---

- ▶ **Basic Operations for Scanning Originals(P. 233)**

# Specifying E-Mail Settings

2KUU-058



When attaching a scanned original(s) to an e-mail, you can specify the subject, message, reply-to address, and priority for the e-mail before sending it.

- 1 Place the original(s). ▶ **Placing Originals(P. 128)**
- 2 Select <Scan> in the Home screen. ▶ **Home Screen(P. 111)**
- 3 Select <E-Mail>.
- 4 Specify the destination, and configure the scan settings as necessary. ▶ **Basic Operations for Scanning Originals(P. 233)**
- 5 Specify the subject, message, reply-to address, and priority for the e-mail.

Send: Press Start	
Destinations: 001	
To:  john@example.com	
Data Size: Standard	▲
Subject/Message: (Entered)	5/6
Destination	▼

## ■ To specify subject/message

- 1 Select <Subject/Message>.
- 2 Select <Subject>.
- 3 Enter the subject, and select <Apply>.
  - On how to enter text, see ▶ **Entering Text(P. 123)** .
- 4 Select <Message>.
- 5 Enter the message, and select <Apply>.
- 6 Select <Apply>.

## ■ To specify reply-to address

Specify the reply-to address when you want to notify the recipient of an e-mail address different from that of the machine as the reply-to address. Select the target reply-to address from the destinations registered in the Address Book, and specify it. If the destination has not been registered in the Address Book, see ▶ **Registering Destinations(P. 161)** .

- 1 Select <Reply To>.
- 2 Select <Specify from Address Book>.
- 3 Select a reply-to address.

### ■ To specify priority

- 1 Select <Priority>.
- 2 Select a priority level.

## 6 Press .

⇒ Scanning of the original starts.

- If you want to cancel, select <Cancel> ► <Yes>. [▶ Canceling Sending Documents\(P. 247\)](#)

### ■ When placing originals in the feeder in step 1

When scanning is complete, the e-mails are sent.

### ■ When placing originals on the platen glass in step 1

When scanning is complete, follow the procedure below (except if you selected JPEG as a file format).

- 1 If there are additional pages of originals to be scanned, place the next original on the platen glass, and press .
  - Repeat this step until you finish scanning all of the pages.
  - When there is only one page to be scanned, proceed to the next step.
- 2 Select <Start TX>.
 

⇒ The e-mails are sent.

## TIPS

- If you always want to scan with the same settings: [▶ Changing the Default Settings for Functions\(P. 154\)](#)
- If you want to specify the e-mail sender name: [▶ <Register Unit Name \(E-Mail\)>\(P. 402\)](#)

## LINKS

- ▶ [Checking Status and Log for Scanned Originals\(P. 249\)](#)

## Using Your Computer to Scan (Remote Scan)

2KUU-059

To scan from a computer, you can use MF Scan Utility or an application such as an image processing or word processing application. If you use ScanGear MF supplied with the machine, you can configure advanced scan settings ( **Using ScanGear MF(P. 264)** ).



### IMPORTANT

- When using the machine with a USB connection, exit sleep mode before scanning. **Entering Sleep Mode(P. 159)**

### Scanning Using MF Scan Utility



MF Scan Utility is an application included with the machine that enables you to scan documents or images to a computer. You can forward the scanned data to a specified application, or attach it to an e-mail message. For more information, click [Instructions] on MF Scan Utility.

### NOTE

- If you are a macOS user, see the manuals for the relevant drivers or software on the online manual website.

### Scanning Using an Application



You can scan images by using an application such as a word-processing or image-processing application, and load the images directly into the application. You do not need to start another application to scan. **Scanning Documents from an Application(P. 262)**

# Scanning Documents from an Application

2KUU-05A



You can scan originals from applications such as image-processing or word-processing software. The scanned image is directly loaded in the application, allowing you to edit or process the image immediately. The following procedure varies depending on the application.

## IMPORTANT

- The application must be compatible with TWAIN or WIA\*. For more information, see the instruction manual for your application.

\*TWAIN is a standard for connecting image input devices, such as scanners, with computers. WIA is a function that is an integrated standard in Windows.

### 1 Place the original(s). ▶ **Placing Originals(P. 128)**

#### IMPORTANT:

- The second or subsequent originals may not be scanned, or an error message may be displayed depending on the application. In such a case, place and scan one original at a time.
- When <Auto Online for Remote Scan> is set to <Off>, you must press <Scan> (  (COPY/SCAN)) ▶ <Remote Scanner> to bring the machine online. ▶ **<Auto Online for Remote Scan>(P. 424)**

### 2 From the application, select the start scan command.

- The procedure for selecting the start scan command varies depending on the application. For more information, see the instruction manual for your application.

### 3 Select the scanner driver for this machine.

- Select ScanGear MF or WIA. If you select ScanGear MF, you can configure advanced scan settings.

### 4 Specify the scanning settings as necessary.

### 5 Click [Scan].

⇒ Scanning of the original starts.

- When scanning is complete, the scanned image is forwarded to an application.

#### How to use ScanGear MF

- Click  on the ScanGear MF screen, and see the Help.

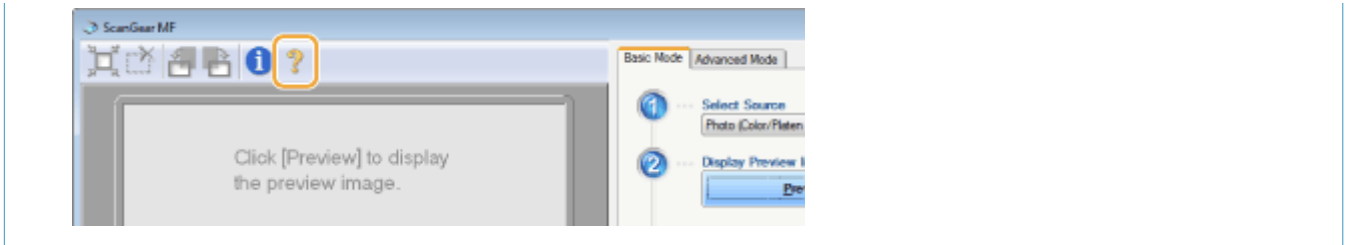

## LINKS

---

▶ **Using ScanGear MF(P. 264)**

## Using ScanGear MF

2KUU-05C



ScanGear MF is a scanner driver included with the machine. You can use ScanGear MF to configure advanced scan settings when you scan. The way of starting ScanGear MF differs depending of the way of scanning from the computer.

### Starting from MF Scan Utility

When scanning from MF Scan Utility, click [ScanGear] to start ScanGear MF. For more information, click [Instructions] on MF Scan Utility.

### NOTE

- If you are a macOS user, see the manuals for the relevant drivers or software on the online manual website.

### Starting from an application

To scan from applications such as image-processing or word-processing software, select ScanGear MF as scanner driver. **☞ Scanning Documents from an Application(P. 262)**

## TIPS

### Functions of ScanGear MF

- Previewing the image before scanning
- Specifying the original scanning area
- Adjusting the detailed image quality

### How to use ScanGear MF

- Click  on the ScanGear MF screen, and see the Help.

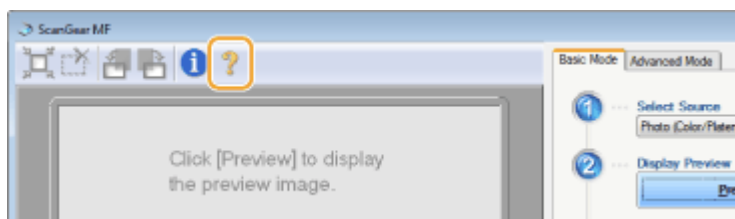

# Linking with Mobile Devices

<b>Linking with Mobile Devices</b> .....	266
<b>Connecting with Mobile Devices</b> .....	267
Connecting via a Wireless LAN Router (LAN Connection) .....	268
Connecting Directly (Access Point Mode) .....	269
<b>Utilizing the Machine through Applications</b> .....	272
<b>Using AirPrint</b> .....	273
Printing with AirPrint .....	278
Scanning with AirPrint .....	281
Faxing with AirPrint .....	283
If AirPrint Cannot Be Used .....	285
<b>Using Google Cloud Print</b> .....	286
<b>Managing the Machine by the Remote Control</b> .....	288



## Linking with Mobile Devices

2KUU-05E

Linking the machine with mobile devices such as smart phones and tablets enables you to use an appropriate application to perform printing, or other operation with ease. In addition, you can operate the machine from mobile devices via remote control to confirm printing status and change the settings of the machine.



- ▶ **Connecting with Mobile Devices(P. 267)**
- ▶ **Connecting Directly (Access Point Mode)(P. 269)**
- ▶ **Utilizing the Machine through Applications(P. 272)**
- ▶ **Using AirPrint(P. 273)**
- ▶ **Using Google Cloud Print(P. 286)**
- ▶ **Managing the Machine by the Remote Control(P. 288)**

### IMPORTANT

- Depending on your mobile device, the machine may not operate correctly.

## Connecting with Mobile Devices

---

2KUU-05F

There are two methods used to connect a mobile device with the machine: connecting via a wireless LAN router, and communicating wirelessly and directly with the machine. Select a connection method in accordance with the communication environment and the device you are using.

### ■ Connecting via a Wireless LAN Router

Just as connecting a computer to the machine, connect a mobile device to the machine via a wireless LAN router. ▶ **Connecting via a Wireless LAN Router (LAN Connection)(P. 268)**



### ■ Connecting Directly

Directly connect a mobile device to the machine wirelessly without using wireless LAN. It is possible to immediately connect to the machine wirelessly even outside of a wireless LAN environment. ▶ **Connecting Directly (Access Point Mode)(P. 269)**



## Connecting via a Wireless LAN Router (LAN Connection)

2KUU-05H

If a wireless LAN router is connected to the network connected to the machine, you can establish a communication with a mobile device via the wireless LAN router in the same way for a computer. For information about how to connect a mobile device to your wireless LAN router, see the instruction manuals for your networking devices or contact your manufacturer. Connect the machine to a router via the wired or wireless LAN. **▶Setting Up the Network Environment(P. 14)**



### NOTE

- If your mobile devices do not support IPv6, use the IPv4 address. **▶Setting IPv4 Address(P. 32)**

**1** Press .

**2** Select <Network Information>.

**3** Display the IP address of the machine.

#### ■IPv4

- Select <IPv4> ▶ <IP Address>.

#### ■IPv6

- Select <IPv6> ▶ <Link-Local Address> ▶ <IP Address>.

**4** Connect from the mobile device to the IP address that appears on the screen.

## Connecting Directly (Access Point Mode)

2KUU-05J

Even in an environment without a wireless LAN router, using "Access Point Mode," which can directly connect a mobile device to the machine wirelessly, enables you to connect the mobile device on hand to the machine without difficult settings.



- ▶ **Preparing for Direct Connection (Access Point Mode)(P. 269)**
- ▶ **Connecting Directly (Touch Panel Model)(P. 270)**
- ▶ **Connecting Directly (5 Lines LCD Model)(P. 270)**

### Preparing for Direct Connection (Access Point Mode)

Establish a connection by using Access Point Mode in the following order (only for IPv4 environment).



#### 1 Preparing the mobile device

- Configure settings to connect the mobile device to Wi-Fi.



#### 2 Put the machine into the connection standby status.

- <Menu> (  ) ▶ <Network Settings> ▶ <Direct Connection Settings> ▶ set <Use Direct Connection> to <On>.

## NOTE

### Specifying the value for time until auto termination

- You can specify the time to automatically establish a disconnection when the direct connection is enabled. ▶ **<Time Until Direct Connection Termination>(P. 365)**

### Connecting multiple mobile devices at the same time

- Configure the machine's SSID and network key arbitrarily. The network key can be left blank. ▶ **<Access Point Mode Settings>(P. 365)**

### Changing the IP address for direct connection

- The IP address for direct connection is set automatically. You can also set any IP address. ▶ **<IP Address Settings for Direct Conn.>(P. 365)**

## Connecting Directly (Touch Panel Model)

### IMPORTANT

- It may take time until a connection of the machine and the mobile device is established.

**1** Select **<Direct Conn>** in the Home screen.  **Home Screen(P. 111)**

- If a message appears, continue by following the instructions on the screen.

**2** Configure the Wi-Fi settings from the mobile device using the SSID and network key information that appear on the display.

**3** When the target operation is completed, select **<Disconnect>**  **<Yes>**.

## Connecting Directly (5 Lines LCD Model)

### IMPORTANT

- It may take time until a connection of the machine and the mobile device is established.

**1** Press , and select **<Direct Connection>**.

- If a message appears, continue by following the instructions on the screen.

**2** Select **<Display SSID/Network Key>**.

**3** Configure the Wi-Fi settings from the mobile device using the SSID and network key information that appear on the display.

**4** When the target operation is completed, press , then select **<Disconnect>**  **<Yes>**.

### TIPS

- Select **<Conn. Info>/<Connection Information>** on the screen under the direct connection to check the connected mobile device.

### IMPORTANT

- While connecting via direct connection, you may not be able to connect to the Internet depending on the mobile device you are using.
- If a wireless connection from the mobile device is not performed within 5 minutes while the SSID and network key are displayed, the connection waiting state terminates.
- If the status without data transmission between the mobile device and the machine continues during communication by direct connection, the communication may end.
- Power saving performance of sleep mode degrades while connecting via direct connection.
- If the machine is used with a wireless LAN, you need to keep the machine connected to the wireless LAN when using direct connection. When the machine is not connected to a wireless LAN or the connection process is not complete yet, the direct connection process cannot begin. If the connection between the machine and the wireless LAN is lost during communication through direct connection, the communication may end.
- When you finish the desired operation, be sure to terminate the connection between the machine and the mobile device. If they remain connected, power saving performance of sleep mode degrades.
- If you use the direct connection, do not set the IP address manually on the mobile device. Doing so may prevent proper communication after using the direct connection.

# Utilizing the Machine through Applications

2KUU-05K

Perform printing and other operations from the mobile device connected to the machine using applications. Various applications including those exclusive to Canon are supported. Use properly in accordance with your device, the application, and the situation.

## ■ Using Canon PRINT Business

This application is used to perform printing and other operations from mobile devices that support iOS/Android. When printing, it is not necessary to perform operations on the machine. For more information on supported operating systems, detailed setting methods, and operations, see the application's Help or the Canon website (<http://www.canon.com/gomp/>).

### IMPORTANT

- You can download Canon PRINT Business for free, but you will be charged the Internet connection fee.

## ■ Printing with Canon Print Service

You can easily print from the menu of applications that support the Android print subsystem. For more information on supported operating systems and detailed settings and procedures, see the Canon website (<http://www.canon.com/>).

## ■ Printing by Mopria®

The machine also supports Mopria®. Using Mopria® enables you to print from mobile devices that support Android using common operations and settings, even if manufacturers and models differ. For example, if you are using printers supporting Mopria® made by multiple manufacturers or a printer supporting Mopria® that is located in a place you are visiting, you can print without installing an application exclusive for each manufacturer or model. For more information on supporting models or operation environments, see <http://www.mopria.org>.



## ■ Printing with Google Cloud Print

You can use applications and services which support Google Cloud Print to print from a computer or mobile device without using a printer driver. ▶ **Using Google Cloud Print(P. 286)**

# Using AirPrint

2KUU-0A9

This section describes the settings required to use AirPrint and the procedures to be performed using Apple devices.



## AirPrint Settings

- ▶ [Configuring AirPrint Settings\(P. 273\)](#)
- ▶ [Displaying the Screen for AirPrint\(P. 276\)](#)

## Functions of the AirPrint

- ▶ [Printing with AirPrint\(P. 278\)](#)
- ▶ [Scanning with AirPrint\(P. 281\)](#)
- ▶ [Faxing with AirPrint\(P. 283\)](#)

## Troubleshooting

- ▶ [If AirPrint Cannot Be Used\(P. 285\)](#)

## Configuring AirPrint Settings

You can register information, including the name of the machine and installation location, that is used for identifying the machine. You can also disable the AirPrint function of the machine. Use the Remote UI to change these settings.

### NOTE

- For more information about the basic operations to be performed when setting the machine from the Remote UI, see [▶Setting Up Menu Options from Remote UI\(P. 344\)](#) .

**1** Start the Remote UI and log in to System Manager Mode. [▶Starting Remote UI\(P. 335\)](#)

**2** Click [Settings/Registration] on the Portal page. [▶Remote UI Screen\(P. 336\)](#)

- If you are using a mobile device, such as an iPad, iPhone, or iPod touch, read "click" as "tap" in this section.

**3** Select [Network Settings] ▶ [AirPrint Settings].

**4** Click [Edit].



## 5 Specify the required settings.

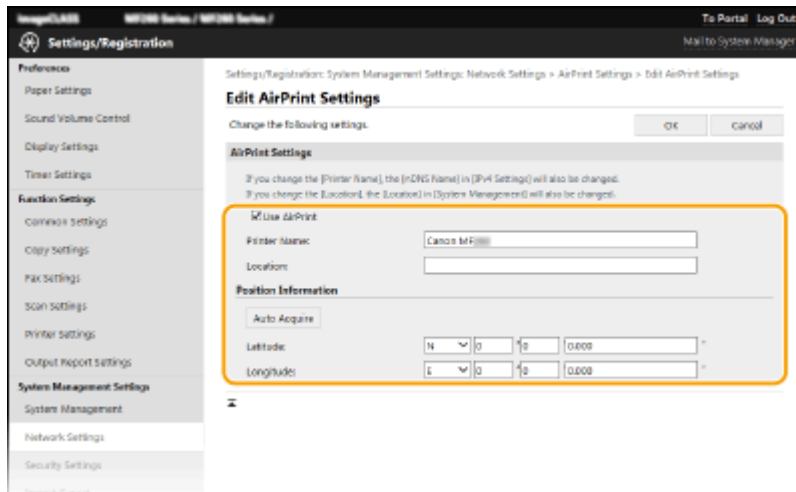

### [Use AirPrint]

Select the check box to enable AirPrint. To disable AirPrint, clear the check box.

### [Printer Name]

Enter the name of the machine. If an mDNS name has already been registered in [mDNS Settings] ( [▶ Configuring DNS\(P. 57\)](#) ), the registered name is displayed.

### [Location]

Enter the location of the machine. If a location has already been registered in [Device Information] ([System Management] in [System Management Settings] (Settings/Registration)), the registered name is displayed.

### [Latitude]

Enter the latitude of the location where the machine is installed.

### [Longitude]

Enter the longitude of the location where the machine is installed.

## 6 Click [OK].

## IMPORTANT

If you select [Use AirPrint], the following settings are set to on.

- <Use HTTP>
- [IPP Print Settings]
- <mDNS Settings> (IPv4 Settings)
- <mDNS Settings> (IPv6 Settings)
- <Network Link Scan Settings>

## NOTE

- If you change [Printer Name] that you have once specified, you may be unable to print any more from the Mac that has been able to be used for printing so far. This phenomenon occurs because [mDNS Name] ( [▶ Configuring DNS\(P. 57\)](#) ) of IPv4 is also changed automatically. In this case, add the machine to the Mac again.
- Entering the printer name makes it easier to identify multiple printers that support AirPrint.

## ■ Changing the Setting of Functions Available with AirPrint

If you want to disable functions that you are not going to use with AirPrint or encrypt communications, configure the necessary setting using the operation panel or Remote UI.

### Changing Print and Fax Settings

To perform printing or fax sending with AirPrint, IPP protocol is used.

#### Turning the Function On/Off

You can specify whether to perform printing or fax sending with AirPrint. The factory default setting is [On].



Log in to the Remote UI in System Manager Mode ( **▶ Starting Remote UI(P. 335)** ) ▶  
 [Settings/Registration] ▶ [Network Settings] ▶ [TCP/IP Settings] ▶ [Edit] in [IPP Print Settings]  
 ▶ Clear or select the [Use IPP Printing] check box ▶ [OK]

#### Changing the TLS Setting

You can specify whether to encrypt communications using TLS when performing printing or fax sending with AirPrint. The factory default setting is [On].



Log in to the Remote UI in System Manager Mode ( **▶ Starting Remote UI(P. 335)** ) ▶  
 [Settings/Registration] ▶ [Network Settings] ▶ [TCP/IP Settings] ▶ [Edit] in [IPP Print Settings]  
 ▶ Clear or select the [Use TLS] check box ▶ [OK]

### Changing the Scan Setting

Configure the scan setting using AirPrint.

#### Set the Function to Enable or Disable

You can turn on/off the scan function available with AirPrint. The factory default setting is <On>.



<Menu> (  ) ▶ <Network Settings> ▶ <TCP/IP Settings> ▶ <Network Link Scan Settings>  
 ▶ Set <Use Network Link Scan> to <Off> or <On>

#### Change TLS Settings

You can specify whether or not to encrypt TLS communications when scanning data using AirPrint. The factory default setting is <On>.



## Displaying the Screen for AirPrint

You can display the screen for AirPrint, on which you can not only access the AirPrint Settings but also view information about consumables, such as paper and toner cartridge, etc. Further, you can configure security function settings.

- 1** Select [System Preferences] ▶ [Printers & Scanners], then add the machine to the Mac you are using.
  - If the machine has already been added, this operation is not required.
- 2** Select this machine from the list of printers in [Printers & Scanners].
- 3** Click [Options & Supplies].
- 4** Click [Show Printer Webpage].
- 5** Log in to the Remote UI.
  - To change the AirPrint settings, it is necessary to log in as an administrator.

### ■ AirPrint-Dedicated Page

When you log in with administrator privileges, the AirPrint-dedicated page is displayed as shown below.

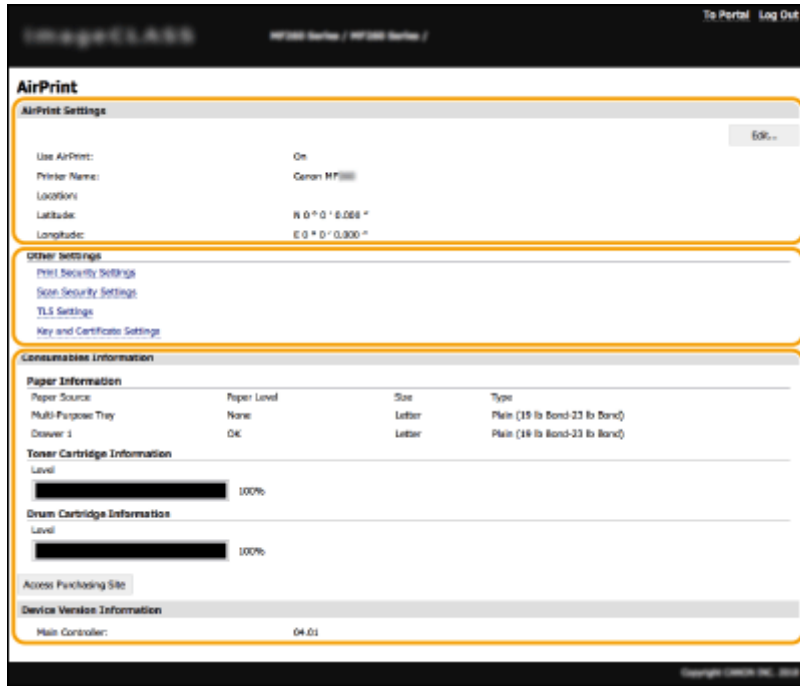

### 1 [AirPrint Settings]

Enables you to check the values entered in the AirPrint settings, such as the name and location of the machine. You can click [Edit] to change the settings.

### 2 [Other Settings]

#### [Print Security Settings]

Configure the print security settings using TLS or authentication.

#### [Scan Security Settings]

Configure the scan security settings using TLS.

#### [TLS Settings]

Enables you to change the key and certificate used for TLS. ▶ **Configuring the Key and Certificate for TLS(P. 308)**

#### [Key and Certificate Settings]

Enables you to generate and install a key and certificate, or request a certificate to be issued. ▶ **Configuring the Key and Certificate for TLS(P. 308)**

### 3 [Consumables Information]

Enables you to check the information of a paper source and consumables of the machine and the device version.

## Trademarks

Apple, Bonjour, iPad, iPhone, iPod touch, Mac, macOS, OS X and Safari are trademarks of Apple Inc., registered in the U.S. and other countries. AirPrint and the AirPrint logo are trademarks of Apple Inc.

# Printing with AirPrint

You can print from an iPad, iPhone, iPod touch, or Mac without using a printer driver.



▶ **Printing from an iPad, iPhone, or iPod touch(P. 278)**

▶ **Printing from a Mac(P. 279)**

## System Requirements

One of the following Apple devices is required to print with AirPrint.

- iPad (all models)
- iPhone (3GS or later)
- iPod touch (3rd generation or later)
- Mac (Mac OS X 10.7 or later)\*

\*OS X v10.9 or later when using a USB connection

## Network Environment

One of the following environments is required.

- An environment where an Apple device and the machine are connected to the same LAN
- An environment where an Apple device and the machine are connected directly
- An environment where a Mac is connected to the machine via USB

## IMPORTANT

- For printing, it is required to set [Use IPP Printing] to [On]. ▶ **Changing the Setting of Functions Available with AirPrint(P. 275)**

## Printing from an iPad, iPhone, or iPod touch

**1** Make sure that the machine is turned ON and connected to the Apple device.

- For how to make sure of this, see ▶ **Setting Up the Network Environment(P. 14)** .
- For information on the Direct Connection, see ▶ **Connecting Directly (Access Point Mode)(P. 269)** .

**2** From the application on your Apple device, tap  to display the menu options.

**3 Tap [Print].****4 Select this machine from [Printer].**

- The printers connected to the network are displayed here. Select this machine in this step.

**IMPORTANT:**

- The screen for selecting this machine in [Printer] is not displayed on applications that do not support AirPrint. You cannot print by using those applications.

**5 Specify the print settings as necessary.****NOTE:**

- The available settings and paper sizes differ depending on the application you are using.

**6 Tap [Print].**

▢ Printing starts.

**NOTE:****Checking the print status**

- During printing, press the Home button of the Apple device twice ► tap [Print].

## Printing from a Mac

**1 Make sure that the machine is turned ON and connected to the Mac.**

- For how to make sure of this, see [▶Setting Up the Network Environment\(P. 14\)](#) .

**2 Add the machine to the Mac from [System Preferences] ► [Printers & Scanners].**

- If the machine has already been added, this operation is not required.

**3 Open a document in an application and display the print dialog box.**

- How to display the print dialog box differs for each application. For more information, see the instruction manual or Help for the application you are using.

**4 Select the machine in the print dialog box.**

- The printers connected to the Mac are displayed. Select this machine in this step.

**5 Specify the print settings as necessary.**

**NOTE:**

- The available settings and paper sizes differ depending on the application you are using.

**6 Click [Print].**

⇒ Printing starts.

## Scanning with AirPrint

2KUU-05S

You can use AirPrint to transfer the data scanned by the machine directly to a Mac.

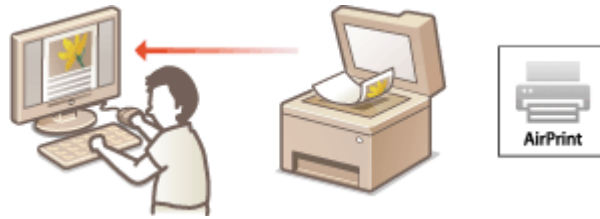

### System Requirements

To scan with AirPrint, you need a Mac with OS X 10.9 or later installed. To scan using TLS, you need a Mac with OS X 10.11 or later installed.

### Network Environment

One of the following environments is required.

- An environment where an Apple device and the machine are connected to the same LAN
- An environment where a Mac is connected to the machine via USB

## IMPORTANT

- For scanning, it is required to set <Use Network Link Scan> to <On>. **▶ Changing the Setting of Functions Available with AirPrint(P. 275)**
- Before scanning, it is required to put the machine into online state. When the auto online function (<Auto Online for Remote Scan>) is set to <Off>, first put the machine into online state by selecting <Scan> ▶ <Remote Scanner>, then start the procedure for scanning.
- You cannot scan while settings for operations are being made, or while the machine is performing any operation whatsoever.

## Scanning from a Mac

- 1 Make sure that the machine is turned ON and connected to the Mac.**
  - For how to make sure of this, see **▶ Setting Up the Network Environment(P. 14)** .
- 2 Add the machine to the Mac from [System Preferences] ▶ [Printers & Scanners].**
  - If the machine has already been added, this operation is not required.
- 3 Select this machine from the list of printers in [Printers & Scanners].**
- 4 Click [Scan].**



**5 Click [Open Scanner].**

⇒ The [Scanner] screen is displayed.

**6 Configure the scan settings as necessary.**

**7 Click [Scan].**

⇒ The original is scanned, and the image is displayed.

## Faxing with AirPrint

2KUU-05U

You can send faxes from a Mac in almost the same way as when you print from a Mac.



### System Requirements

To send faxes with AirPrint, you need a Mac with OS X 10.9 or later installed.

### Network Environment

One of the following environments is required.

- An environment where an Apple device and the machine are connected to the same LAN
- An environment where a Mac is connected to the machine via USB

## IMPORTANT

- For faxing, it is required to set [Use IPP Printing] to [On]. [▶ Changing the Setting of Functions Available with AirPrint\(P. 275\)](#)

## Faxing from a Mac

### 1 Make sure that the machine is turned ON and connected to the Mac.

- For how to make sure of this, see [▶ Setting Up the Network Environment\(P. 14\)](#) .

### 2 Add the machine to the Mac from [System Preferences] ▶ [Printers & Scanners].

- If the machine has already been added, this operation is not required.

### 3 Open a document in an application and display the print dialog box.

- How to display the print dialog box differs for each application. For more information, see the instruction manual for the application you are using.

### 4 Select this machine in the print dialog box.

- ▣▶ The printers connected to the Mac are displayed. Select the fax driver of this machine in this step.

### 5 Specify the destination.

## **6** Click [Fax].

⇒ Fax sending starts.

## If AirPrint Cannot Be Used

---

2KUU-05W

If AirPrint cannot be used, try taking the following solutions.

- Make sure that the machine is turned ON. If the machine is turned ON, first turn it OFF, then wait for at least 10 seconds and then turn it back ON to check if the problem is solved.
- Make sure that no error messages are displayed on the machine.
- Make sure that Apple devices and the machine are connected to the same LAN. If the machine is turned ON, it may take several minutes before the machine is ready for communication.
- Make sure that Bonjour on your Apple device is enabled.
- For printing, make sure that the paper is loaded in the machine and that the machine contains a sufficient amount remaining in the toner cartridge and the drum cartridge. **▶ Displaying the Screen for AirPrint(P. 276)**
- For scanning, make sure that the machine's setting for Network Link Scan is <On>. **▶ Changing the Setting of Functions Available with AirPrint(P. 275)**

## Using Google Cloud Print

2KUU-05X

Google Cloud Print is a service that enables a user with a Google account to print from a smartphone, tablet, or computer connected to the Internet using applications compatible with Google Cloud Print. Unlike conventional printing from a computer, it does not require a printer driver.



- ▶ **Checking the Settings of the Machine(P. 286)**
- ▶ **Registering the Machine with Google Cloud Print(P. 286)**

### IMPORTANT

- An environment in which you can connect to the internet is required when registering the machine and when printing using Google Cloud Print. In addition, the customer is responsible for any fees regarding internet connection.
- Google Cloud Print may not be available, depending on your country or region.

### NOTE

- A Google account is required to use Google Cloud Print. If you do not have a Google account, create one on the Google website.

## Checking the Settings of the Machine

Check the following before configuring cloud printing.

Make sure that the IPv4 address or IPv6 address is specified for the machine, and that the machine is able to communicate with computers on a network.

- ▶ **Connecting to a Wired LAN(P. 17)**
- ▶ **Connecting to a Wireless LAN(P. 18)**
- Check whether the date and time of the machine are specified correctly. ▶ **Setting the Date/Time(P. 11)**

## Registering the Machine with Google Cloud Print

Registering the machine with Google Cloud Print enables you to print from anywhere using the service.

### NOTE

- For more information about the basic operations to be performed when setting the machine from the Remote UI, see ▶ **Setting Up Menu Options from Remote UI(P. 344)** .

- 1 Start the Remote UI and log in as an administrator. ▶ Starting Remote UI(P. 335)
- 2 Click [Settings/Registration] on the Portal page. ▶ Remote UI Screen(P. 336)
- 3 Select [Network Settings] ▶ [Google Cloud Print Settings].
- 4 Click [Edit] for [Basic Settings].
- 5 Select the [Use Google Cloud Print] check box ▶ [OK].
- 6 Click [Register] in [Registration Status].

**NOTE:****Re-Registering the Machine**

- To re-register the machine, delete its registration before registering it again.

- 7 Click the URL link displayed for [URL for Registration].
- 8 Follow the instructions on the screen to register the machine.

⇒ Printing can now be performed from applications that support Google Cloud Print, such as Google Chrome™.

**NOTE:**

- For information on the latest applications that support Google Cloud Print, check the Google Cloud Print home page.

**NOTE****Configuring Settings on the Operation Panel**

- You can also enable or disable the Cloud Print function from the <Menu> screen. ▶ <Google Cloud Print Settings>(P. 426)

**Registering from a Mobile Device or Google Chrome**

- You can register the machine from a mobile device or Google Chrome. The machine's display shows the confirmation screen before completion of the registration. Select <Yes> to complete the registration.
- For information on registration methods, see the manual of your device or the Google Cloud Print website.

# Managing the Machine by the Remote Control

2KUU-05Y

You can use the Remote UI from a smart phone or tablet Web browser. You can confirm the machine status or perform various settings from a mobile device.



## Supported Web Browsers

Web browsers supporting the Remote UI for mobile devices are the following.

### Android OS

- Chrome

### iOS

- Safari

## Starting the Remote UI from Mobile Devices

Enter the IP address of the machine on the Web browser to start the Remote UI. Prior to operation, confirm the IP address set for the machine ( [Viewing Network Settings\(P. 38\)](#) ). If it is unknown, ask your network administrator.

**1 Start the Web browser of the mobile device.**

**2 Enter "http://<the IP address of the machine>/" in the address entry column.**

- If you want to use an IPv6 address, enclose the IPv6 address with brackets.  
**Example:** http://[fe80::2e9e:fcff:fe4e:dbce]/

### NOTE:

- For a "Smartphone Version" of the Remote UI, a portion of items displayed are omitted. If you want to confirm all of the items, see the "PC Version."

## LINKS

[Managing the Machine from a Computer \(Remote UI\)\(P. 334\)](#)

# Managing the Machine

<b>Managing the Machine</b> .....	290
<b>Setting Access Privileges</b> .....	292
Setting the System Manager PIN .....	293
Setting a Remote UI PIN .....	295
<b>Configuring the Network Security Settings</b> .....	297
Restricting Communication by Using Firewalls .....	299
Specifying IP Addresses for Firewall Settings .....	300
Specifying MAC Addresses for Firewall Settings .....	303
Changing Port Numbers .....	305
Setting a Proxy .....	306
Configuring the Key and Certificate for TLS .....	308
Generating the Key and Certificate for Network Communication .....	310
Generating a Key and Certificate Signing Request (CSR) .....	313
Registering the Key and Certificate for Network Communication .....	316
Configuring IEEE 802.1X Authentication Settings .....	318
<b>Restricting the Machine's Functions</b> .....	322
Restricting Access to Address Book and Sending Functions .....	324
Restricting Use of the Address Book .....	325
Limiting Available Destinations .....	327
Restricting the Fax Sending Functions .....	329
Restricting USB Functions .....	331
Disabling HTTP Communication .....	332
Disabling Remote UI .....	333
<b>Managing the Machine from a Computer (Remote UI)</b> .....	334
Starting Remote UI .....	335
Checking the Status and Logs .....	338
Setting Up Menu Options from Remote UI .....	344
<b>Registering Destinations from Remote UI</b> .....	347
<b>Saving/Loading Address Book from Remote UI</b> .....	351
<b>Importing/Exporting Address Book Data with the Supplied Software</b> .....	353
<b>Updating the Firmware</b> .....	355
<b>Initializing Settings</b> .....	358



# Managing the Machine

2KUU-060

To reduce the various risks associated with the use of this machine, such as leaks of personal information or unauthorized use by third parties, constant and effective security measures are required. An administrator should manage important settings, such as access privileges and security settings, to ensure that the machine is used safely.

## ■ Configuring the Basic Management System



▶ **Setting Access Privileges(P. 292)**

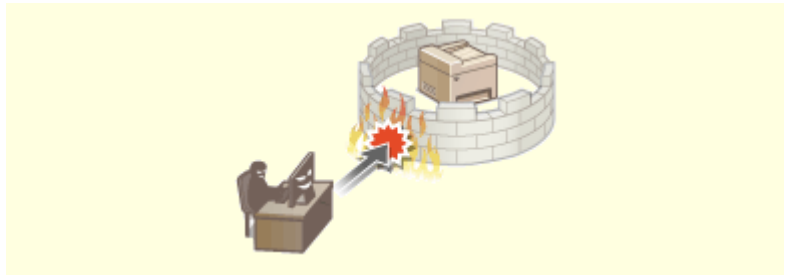

▶ **Configuring the Network Security Settings(P. 297)**

## ■ Preparing for Risks from Negligence or Misuse



▶ **Restricting the Machine's Functions(P. 322)**

## ■ Ensuring Effective Management



▶ **Managing the Machine from a Computer (Remote UI)(P. 334)**

■ Managing the System Configuration and Settings



▶ **Updating the Firmware(P. 355)**

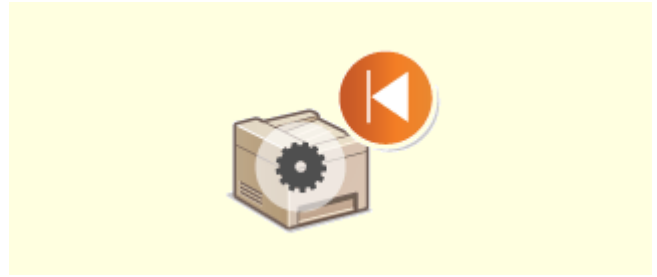

▶ **Initializing Settings(P. 358)**

## Setting Access Privileges

---

2KUU-061

Protect the machine from unauthorized access by only allowing users with access privileges to use the machine. When privileges are set, the user must enter a PIN to change settings or access the Remote UI.



Access privileges are divided into two types: System Manager Mode and General User Mode. System Manager Mode has full access privileges, and a System Manager PIN can be set to restrict login in this mode. And by setting a Remote UI Access PIN, you can restrict use of the Remote UI in General User Mode and in System Manager Mode without a System Manager PIN set.

### System Manager PIN

---

System Manager PIN is intended exclusively for Administrators having full access privileges. If you specify this PIN, you need to log in to the machine using this PIN in order to access <Network Settings> or <System Management Settings>, etc. Set the System Manager PIN when you need different access privilege levels for administrators and general users. [▶Setting the System Manager PIN\(P. 293\)](#)

### Remote UI PIN (Remote UI Access PIN)

---

This is a PIN for using the Remote UI. Only users who know the PIN can access the Remote UI. [▶Setting a Remote UI PIN\(P. 295\)](#)

# Setting the System Manager PIN

2KUU-062

Set a System Manager PIN that is intended exclusively for Administrators. You can access <Network Settings>, <System Management Settings>, etc. only when the PIN has been entered correctly. It is recommended that only Administrators know the PIN.

## 1 Display the <Menu> screen. Home Screen(P. 111)

### Touch Panel Model

Select <Menu> in the Home screen.

### 5 Lines LCD Model

Press .

## 2 Select <System Management Settings>.



## 3 Select <System Manager Information Settings> <System Manager PIN>.

## 4 Specify the System Manager PIN.

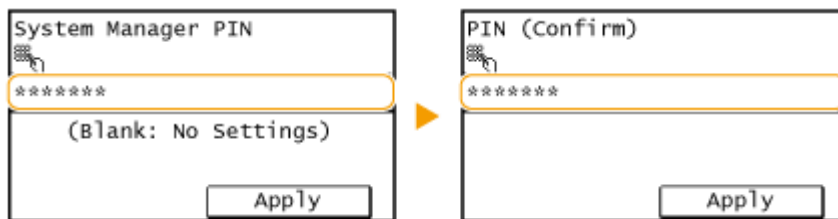
- Enter numbers for each item, and press <Apply> (.
- When <PIN (Confirm)> is displayed, enter the PIN once again to confirm.



### NOTE:

- You cannot set a PIN that consists only of zeros, such as "00" or "0000000."
- To cancel the System Manager PIN settings, clear the information you entered by pressing  and press <Apply> () with the fields blank.

## ■ Setting the System Manager Name

- 1 Select <System Manager Name>.
- 2 Enter the System Manager Name, and select <Apply>.
  - On how to enter text, see  **Entering Text(P. 123)** .

# IMPORTANT

- Do not forget your PIN. If you forget your PIN, contact your local authorized Canon dealer or the Canon help line.

## NOTE

### Configuring settings via the Remote UI

- Start the Remote UI and log in to System Manager Mode. Click [Settings/Registration] ▶ [System Management] ▶ [Edit] and specify the necessary settings on the displayed screen.
- By using the Remote UI, you can register a variety of information, including contact information, Administrator comments, the installation location of the machine, as well as the settings that you can register by using the operation panel. The registered information can be viewed on the [Device Information] page of the Remote UI. ▶ **Checking System Manager Information(P. 341)**

### If a System Manager PIN is Set

- If you try to access <Network Settings> or <System Management Settings>, etc., the following screen is displayed. Enter the set PIN.
- Entering a PIN is also required when logging in in System Manager Mode in the Remote UI. ▶ **Starting Remote UI(P. 335)**

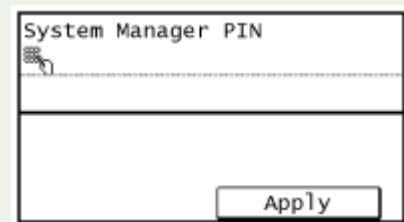

## LINKS

- ▶ **Setting Access Privileges(P. 292)**

# Setting a Remote UI PIN

2KUU-063

You can set a PIN for access to the Remote UI. All users use a common PIN.

## NOTE

- For more information about the basic operations to be performed when setting the machine from the Remote UI, see [▶Setting Up Menu Options from Remote UI\(P. 344\)](#) .

- 1 Start the Remote UI and log in to System Manager Mode. ▶Starting Remote UI(P. 335)**
- 2 Click [Settings/Registration] on the Portal page. ▶Remote UI Screen(P. 336)**
- 3 Select [Security Settings] ▶ [Remote UI Settings].**
- 4 Click [Edit].**
- 5 Select the [Use Remote UI Access PIN] check box and set the PIN.**

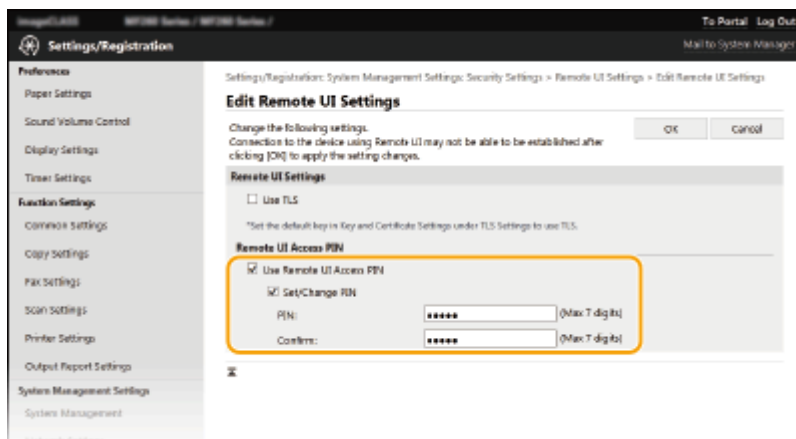

### [Use Remote UI Access PIN]

If you select the check box, you must enter a PIN to access the Remote UI.

### [Set/Change PIN]

To set or change a PIN, select the check box and enter the same number both in the [PIN] and [Confirm] text boxes.

- 6 Click [OK].**

## NOTE

### Using the operation panel

- Remote UI Access PIN settings can also be accessed from the <Menu> screen. [▶<Remote UI Settings>\(P. 423\)](#)

### If <System Management Settings> are initialized

- The Remote UI Access PIN is also initialized. After an initialization, reset the PIN.  <Initialize Menu>(P. 428)

#### LINKS

---

-  [Setting Access Privileges\(P. 292\)](#)
-  [Setting the System Manager PIN\(P. 293\)](#)

# Configuring the Network Security Settings

2KUU-064

Authorized users may incur unanticipated losses from attacks by malicious third parties, such as sniffing, spoofing, and tampering of data as it flows over a network. To protect your important and valuable information from these attacks, the machine supports the following features to enhance security and secrecy.

## Firewall Settings

Unauthorized access by third parties, as well as network attacks and intrusions, can be blocked by limiting communication only to devices that have a specific IP address or MAC address. [Restricting Communication by Using Firewalls\(P. 299\)](#)



## Changing Port Numbers

A protocol that is used to exchange information with other devices is assigned port numbers that are predetermined according to the type of protocol. The port number must be the same for all communication devices; therefore, changing it to an arbitrary number is important to prevent hacking from outside. [Changing Port Numbers\(P. 305\)](#)

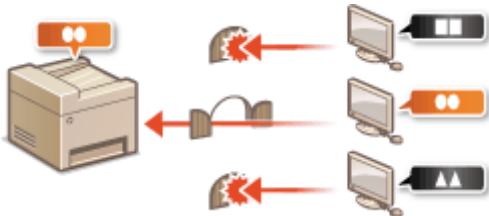

## Proxy Settings

When the client devices are connected to an external network, communication is established through the proxy server. When the proxy server is used, websites can be browsed more safely, therefore, security can be expected to be enhanced. [Setting a Proxy\(P. 306\)](#)



## TLS Encrypted Communication

TLS is a protocol for encryption for data sent over a network and is often used for communication via a Web browser or an e-mail application. TLS enables secure network communication when you access the machine from a computer via the Remote UI. [Configuring the Key and Certificate for TLS\(P. 308\)](#)





### IEEE 802.1X Authentication

IEEE 802.1X is a standard and mechanism for blocking unauthorized access to the network by collectively managing user authentication information. If a device tries to connect to the 802.1X network, the device must go through user authentication in order to prove that the connection is made by an authorized user. Authentication information is sent to and checked by a RADIUS server, which permits or rejects communication to the network depending on the authentication result. If authentication fails, a LAN switch (or an access point) blocks access from the outside of the network. The machine can connect to an 802.1X network as a client device. **➤Configuring IEEE 802.1X Authentication Settings(P. 318)**

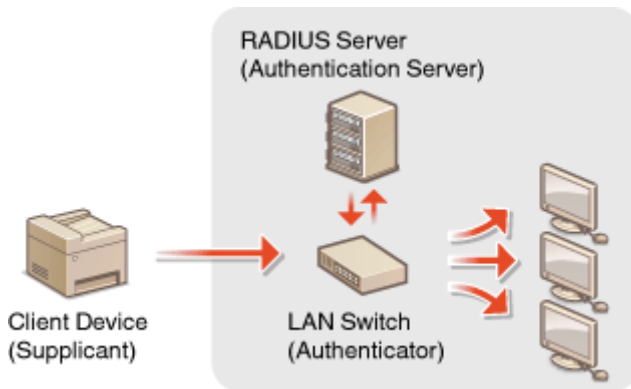

## Restricting Communication by Using Firewalls

2KUU-065

Without proper security, unauthorized third parties can access computers and other communication devices that are connected to a network. To prevent this unauthorized access, specify the settings for packet filter, a feature that restricts communication to devices with specified IP addresses or MAC addresses.

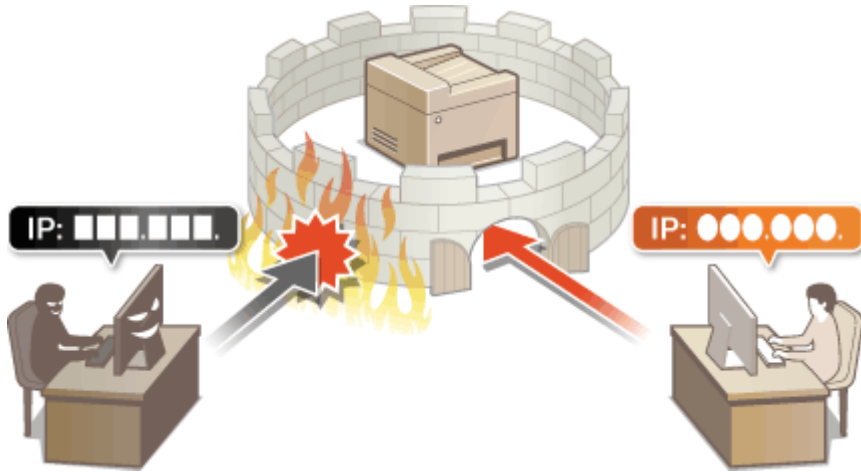

- [Specifying IP Addresses for Firewall Settings\(P. 300\)](#)
- [Specifying MAC Addresses for Firewall Settings\(P. 303\)](#)

# Specifying IP Addresses for Firewall Settings

2KUU-066

You can either limit communication to only devices with specified IP addresses, or block devices with specified IP addresses but permit other communications. You can specify a single IP address or a range of IP addresses.

## NOTE

- For more information about the basic operations to be performed when setting the machine from the Remote UI, see [▶Setting Up Menu Options from Remote UI\(P. 344\)](#) .

**1 Start the Remote UI and log in to System Manager Mode. ▶Starting Remote UI(P. 335)**

**2 Click [Settings/Registration] on the Portal page. ▶Remote UI Screen(P. 336)**

**3 Select [Security Settings] ▶ [IP Address Filter].**

**4 Click [Edit] to specify a filter type.**

**[IPv4 Address: Inbound Filter]**

Restrict data received by the machine from a computer by specifying an IPv4 address.

**[IPv6 Address: Inbound Filter]**

Restrict data received by the machine from a computer by specifying an IPv6 address.

**5 Specify the settings for packet filtering.**

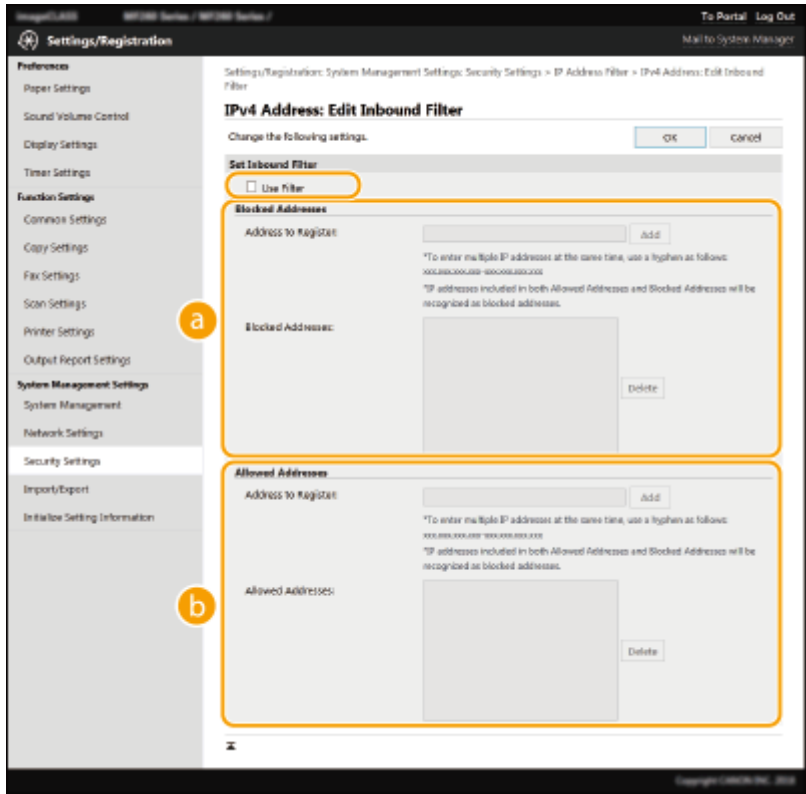

**a [Blocked Addresses]**

Register addresses to be blocked, as well as check or delete registered blocked addresses.

**b [Allowed Addresses]**

Register addresses to be allowed, as well as check or delete registered allowed addresses.

- 1 Select the [Use Filter] check box.
  - Select the check box to restrict communication. Clear the check box to disable the restriction.
- 2 Specify the address.
  - Enter the IP address (or the range of IP addresses) in the [Address to Register] text box and click [Add].

Registered address	Result
[Blocked Addresses]	Restricts communication (received) with devices having IP addresses entered for [Address to Register]. Communication is allowed with devices with any other IP addresses.
[Allowed Addresses]	Allows communication (received) only with devices having IP addresses entered for [Address to Register], and restricts communication with devices with any other IP addresses.
Registered in both	Allows communication (received) only with devices having IP addresses registered in [Allowed Addresses], and restricts communication with devices with any other IP addresses. However, communication is restricted for IP addresses also registered in [Blocked Addresses].

**IMPORTANT:**

**Check for entry errors**

- If IP addresses are incorrectly entered, you may be unable to access the machine from the Remote UI, in which case you need to set <IPv4 Address Filter> or <IPv6 Address Filter> to <Off>.
- ▶<IPv4 Address Filter>(P. 422)

▶<IPv6 Address Filter>(P. 422)

**NOTE:**

Entry form for IP addresses

	Description	Example
Entering a single address	<b>IPv4:</b> Delimit numbers with periods.	192.168.0.10
	<b>IPv6:</b> Delimit alphanumeric characters with colons.	fe80::10
Specifying a range of addresses	Insert a hyphen between the addresses.	192.168.0.10-192.168.0.20
Specifying a range of addresses with a prefix (IPv6 only)	Enter the address, followed by a slash and a number indicating the prefix length.	fe80::1234/64

Deleting an IP address from exceptions

- Select an IP address and click [Delete].

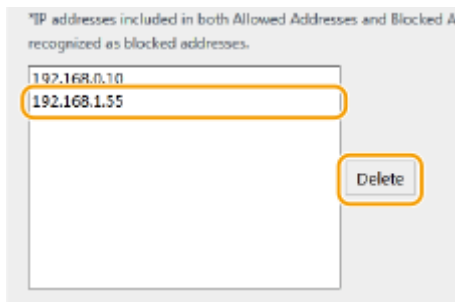

- 3 Click [OK].

**NOTE**

Using the operation panel

- You can also enable or disable IP address filtering from the <Menu> screen.
  - ▶<IPv4 Address Filter>(P. 422)
  - ▶<IPv6 Address Filter>(P. 422)

LINKS

- ▶Specifying MAC Addresses for Firewall Settings(P. 303)

# Specifying MAC Addresses for Firewall Settings

2KUU-067

You can limit communication to only devices with specified MAC addresses.

## IMPORTANT

This function is unavailable when the machine is connected to a wireless LAN.

## NOTE

- For more information about the basic operations to be performed when setting the machine from the Remote UI, see [▶Setting Up Menu Options from Remote UI\(P. 344\)](#) .

**1** Start the Remote UI and log in to System Manager Mode. [▶Starting Remote UI\(P. 335\)](#)

**2** Click [Settings/Registration] on the Portal page. [▶Remote UI Screen\(P. 336\)](#)

**3** Select [Security Settings] ▶ [MAC Address Filter].

**4** Click [Edit] .

**5** Specify the settings for packet filtering.

- Specify MAC addresses for exceptions.

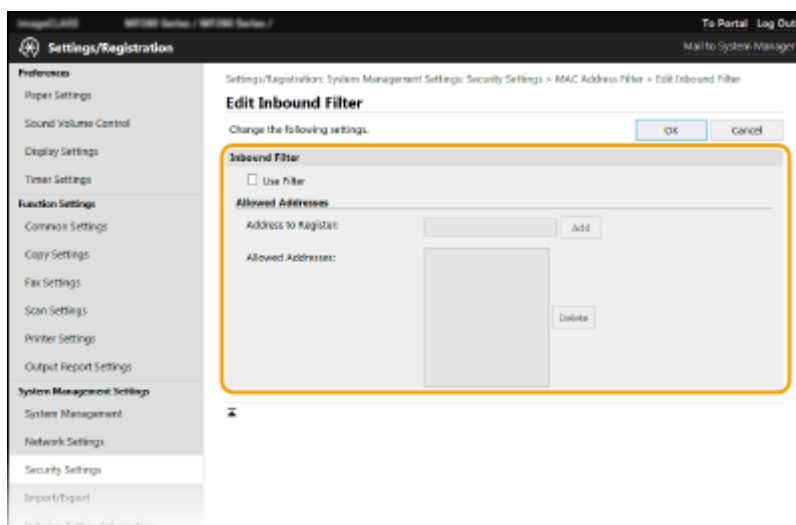

**1** Select the [Use Filter] check box.

- Select the check box to restrict communication. Clear the check box to disable the restriction.

**2** Specify address exceptions.

- Enter the MAC address in the [Address to Register] text box and click [Add].
- You do not need to delimit the address with hyphens or colons.

## IMPORTANT:

### Check for entry errors

- If MAC addresses are incorrectly entered, you may become unable to access the machine from the Remote UI, in which case you need to set <MAC Address Filter> to <Off>. ▶<MAC Address Filter>(P. 423)

## NOTE:

### Deleting a MAC address from exceptions

- Select a MAC address and click [Delete].

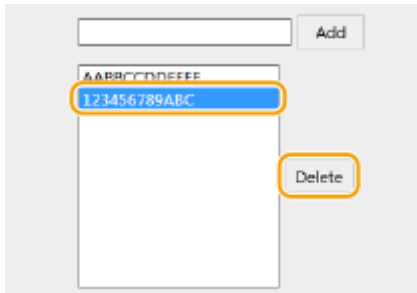

- 3 Click [OK].

## NOTE

### Using the operation panel

- You can also enable or disable MAC address filtering from the <Menu> screen. ▶<MAC Address Filter>(P. 423)

## LINKS

---

- ▶Specifying IP Addresses for Firewall Settings(P. 300)

# Changing Port Numbers

2KUU-068

Ports serve as endpoints for communicating with other devices. Typically, conventional port numbers are used for major protocols, but devices that use these port numbers are vulnerable to attacks because these port numbers are well-known. To enhance security, your Network Administrator may change the port numbers. When a port number has been changed, the new number must be shared with the communicating devices, such as computers and servers. Specify the port number settings depending on the network environment.

## NOTE

- To change the port number for proxy server, see [▶Setting a Proxy\(P. 306\)](#) .

### 1 Display the <Menu> screen. [▶Home Screen\(P. 111\)](#)

#### Touch Panel Model

Select <Menu> in the Home screen.

#### 5 Lines LCD Model

Press .

### 2 Select <Network Settings>.

- If the screen for entering a PIN appears, enter the correct PIN. [▶Setting the System Manager PIN\(P. 293\)](#)

### 3 Select <TCP/IP Settings> ▶ <Port Number Settings>.

### 4 Selecting the protocol of which you want to change the port number.

## NOTE:

#### Learning more about the protocols

- <LPD>, <RAW> or <WSD Multicast Discovery> [▶Configuring Printing Protocols and WSD Functions\(P. 42\)](#)
- <HTTP> [▶Disabling HTTP Communication\(P. 332\)](#)
- <POP3> or <SMTP> [▶Configuring E-Mail Communication Settings\(P. 82\)](#)
- <SNMP> [▶Monitoring and Controlling the Machine with SNMP\(P. 63\)](#)

### 5 Enter the port number, and press <Apply> ( ).

## LINKS

- [▶Configuring Printer Ports\(P. 45\)](#)



## Setting a Proxy

2KUU-069

A proxy (or HTTP proxy server) refers to a computer or software that carries out HTTP communication for other devices, especially when communicating with resources outside the network, such as when browsing Web sites. The client devices connect to the outside network through the proxy server, and do not communicate directly to the resources outside. Setting a proxy not only facilitates management of traffic between in-house and outside networks but also blocks unauthorized access and consolidates anti-virus protection for enhanced security. When you use Google Cloud Print to print over the Internet, you can enhance security by setting a proxy. When setting a proxy, make sure that you have the necessary proxy information, including the IP address, port number, and a user name and password for authentication.

### NOTE

- For more information about the basic operations to be performed when setting the machine from the Remote UI, see [▶Setting Up Menu Options from Remote UI\(P. 344\)](#) .

- 1 Start the Remote UI and log in to System Manager Mode. ▶Starting Remote UI(P. 335)**
- 2 Click [Settings/Registration] on the Portal page. ▶Remote UI Screen(P. 336)**
- 3 Select [Network Settings] ▶ [TCP/IP Settings].**
- 4 Click [Edit] in [Proxy Settings].**
- 5 Select the [Use Proxy] check box and specify the required settings.**

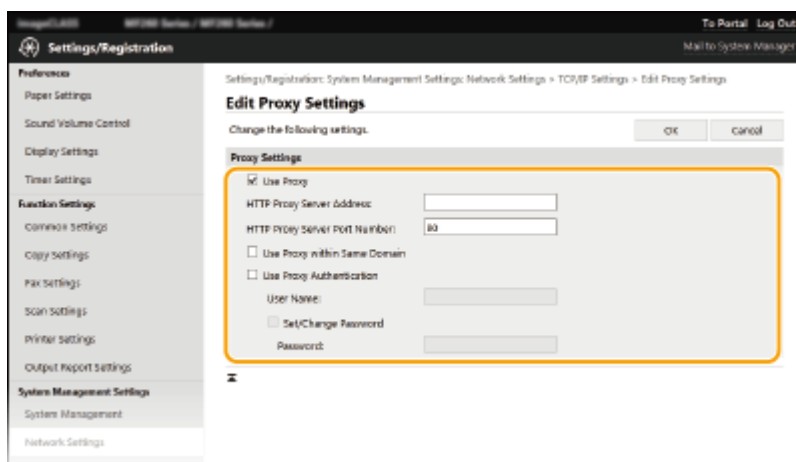

#### [Use Proxy]

Select the check box to use the specified proxy server when communicating with an HTTP server.

#### [HTTP Proxy Server Address]

Enter the address of the proxy server. Specify the IP address or host name depending on the environment.

#### [HTTP Proxy Server Port Number]

Change the port number as necessary.

**[Use Proxy within Same Domain]**

Select the check box to also use the specified proxy server for communication with devices in the same domain.

**[Use Proxy Authentication]**

To enable authentication by the proxy server, select the check box and enter alphanumeric characters for the user name in the [User Name] text box.

**[Set/Change Password]**

To set or change the password for the proxy authentication, when it is enabled, select the check box and enter alphanumeric characters for the new password in the [Password] text box.

**6 Click [OK].**

LINKS

---

▶ **Using Google Cloud Print(P. 286)**

## Configuring the Key and Certificate for TLS

2KUU-06A

You can encrypt communication between the machine and a Web browser on the computer by using Transport Layer Security (TLS). TLS is a mechanism for encrypting data sent or received over the network. TLS must be enabled when the Remote UI is used for specifying settings such as SNMPv3. To use TLS encrypted communication for the Remote UI, you need to specify a "key and certificate" (server certificate) you want to use before enabling TLS. Generate or install the key and certificate for TLS before enabling TLS ( [▶Management Functions\(P. 545\)](#) ).



### NOTE

- For more information about the basic operations to be performed when setting the machine from the Remote UI, see [▶Setting Up Menu Options from Remote UI\(P. 344\)](#) .

- 1 Start the Remote UI and log in to System Manager Mode. [▶Starting Remote UI\(P. 335\)](#)**
- 2 Click [Settings/Registration] on the Portal page. [▶Remote UI Screen\(P. 336\)](#)**
- 3 Select [Network Settings] ▶ [TCP/IP Settings].**
- 4 Click [Key and Certificate] in [TLS Settings].**
- 5 Click [Register Default Key] on the right of the key and certificate you want to use.**

### NOTE:

#### Viewing details of a certificate

- You can check the details of the certificate or verify the certificate by clicking the corresponding text link under [Key Name], or the certificate icon.

### 6 Enable TLS for the Remote UI.

- 1 Click [Security Settings] ▶ [Remote UI Settings].**
- 2 Click [Edit].**
- 3 Select the [Use TLS] check box and click [OK].**

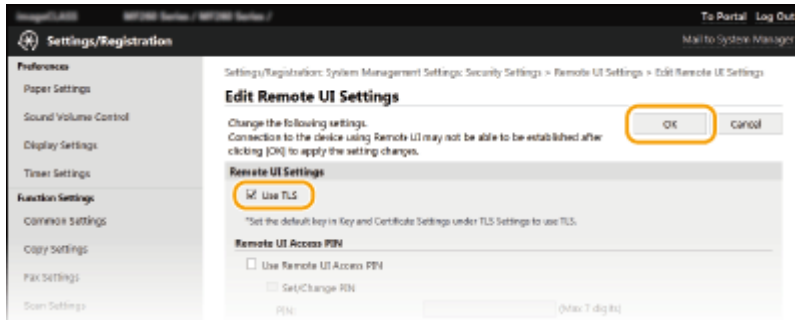

## NOTE

### Using the operation panel

- You can also enable or disable TLS encrypted communication from the <Menu> screen. ▶<Use TLS>(P. 422)

### Starting the Remote UI with TLS

- If you try to start the Remote UI when TLS is enabled, a security alert may be displayed regarding the security certificate. In this case, check that the correct URL is entered in the address field, and then proceed to display the Remote UI screen. ▶<Starting Remote UI>(P. 335)

### Enabling TLS for e-mailing

- If the SMTP server and the POP3 server support TLS, you can enable TLS for communication with these servers ( ▶<Configuring E-Mail Communication Settings>(P. 82) ). For more information about the SMTP server and the POP3 server, contact your Internet service provider or Network Administrator.

## LINKS

- ▶<Monitoring and Controlling the Machine with SNMP>(P. 63)
- ▶<Generating the Key and Certificate for Network Communication>(P. 310)
- ▶<Generating a Key and Certificate Signing Request (CSR)>(P. 313)
- ▶<Registering the Key and Certificate for Network Communication>(P. 316)
- ▶<Configuring IEEE 802.1X Authentication Settings>(P. 318)

# Generating the Key and Certificate for Network Communication

2KUU-06C

A key and certificate can be generated with the machine when it is required for encrypted communication via Transport Layer Security (TLS). You can use TLS when accessing the machine via the Remote UI. Self-signed certificates are used with the key and certificate generated in "Network Communication."

## NOTE

- If you want to use a server certificate that has a CA signature, you can generate a CSR together with a key instead of a certificate. ▶ [Generating a Key and Certificate Signing Request \(CSR\)\(P. 313\)](#)
- For more information about the basic operations to be performed when setting the machine from the Remote UI, see ▶ [Setting Up Menu Options from Remote UI\(P. 344\)](#) .

- 1 Start the Remote UI and log in to System Manager Mode.** ▶ [Starting Remote UI\(P. 335\)](#)
- 2 Click [Settings/Registration] on the Portal page.** ▶ [Remote UI Screen\(P. 336\)](#)
- 3 Select [Security Settings] ▶ [Key and Certificate Settings].**
- 4 Click [Generate Key].**

## NOTE:

### Deleting a registered key and certificate

- Click [Delete] on the right of the key and certificate you want to delete ▶ click [OK].
- A key and certificate cannot be deleted if it is currently used for some purpose, such as when "[TLS]" is displayed under [Key Usage]. In this case, disable the function or replace the other key and certificate before deleting it.

- 5 Select [Network Communication] and click [OK].**
- 6 Specify settings for the key and certificate.**

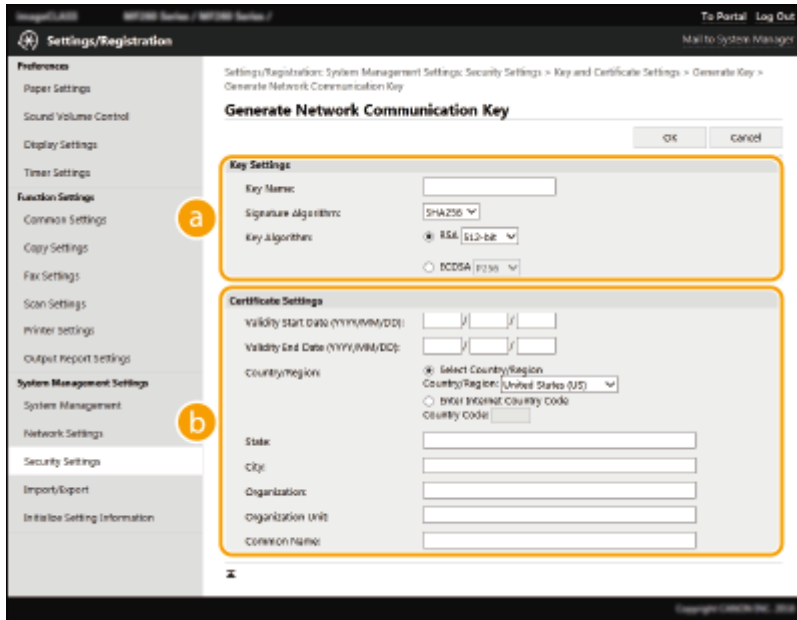

**a [Key Settings]**

**[Key Name]**

Enter alphanumeric characters for naming the key. Set a name that will be easy for you to find later in a list.

**[Signature Algorithm]**

Select the signature algorithm from the drop-down list.

**[Key Algorithm]**

Select the key generation algorithm from [RSA] or [ECDSA], then select the key length from the drop-down list. In either case, the larger the number for the key length is, the higher the security level becomes. However, the communication speed becomes slower.

**NOTE:**

- When [SHA384] or [SHA512] is selected in [Signature Algorithm], [512-bit] cannot be selected as the key length when [RSA] is selected in [Key Algorithm].

**b [Certificate Settings]**

**[Validity Start Date (YYYY/MM/DD)]**

Enter the validity start date of the certificate, in the order of: year, month, day.

**[Validity End Date (YYYY/MM/DD)]**

Enter the validity end date of the certificate, in the order of: year, month, day. A date earlier than [Validity Start Date (YYYY/MM/DD)] cannot be set.

**[Country/Region]**

Click the [Select Country/Region] radio button and select the country/region from the drop-down list. You can also click the [Enter Internet Country Code] radio button and enter a country code, such as "US" for the United States.

**[State]/[City]**

Enter alphanumeric characters for the location as necessary.

**[Organization]/[Organization Unit]**

Enter alphanumeric characters for the organization name as necessary.

**[Common Name]**

Enter alphanumeric characters for the common name of the certificate as necessary. "Common Name" is often abbreviated as "CN."

**7** Click [OK].

- Generating a key and certificate may take some time.
- After the key and certificate is generated, it is automatically registered to the machine.

### LINKS

---

▶ **Configuring the Key and Certificate for TLS(P. 308)**

▶ **Registering the Key and Certificate for Network Communication(P. 316)**

# Generating a Key and Certificate Signing Request (CSR)

2KUU-06E

Because certificates generated on the machine do not have a CA signature, a communication error may result depending on devices it communicates with. To have the certificate authority issue the certificate with the CA signature, you need to obtain data of CSR (Certificate Signing Request), which the administrator can generate from Remote UI. When the certificate is issued, register it in the key with the CSR generated.

▶ **Generating a Key and CSR(P. 313)**

▶ **Registering a Certificate to a Key(P. 315)**

## NOTE

- For more information about the basic operations to be performed when setting the machine from the Remote UI, see ▶ **Setting Up Menu Options from Remote UI(P. 344)** .

## Generating a Key and CSR

- 1 Start the Remote UI and log in to System Manager Mode.** ▶ **Starting Remote UI(P. 335)**
- 2 Click [Settings/Registration] on the Portal page.** ▶ **Remote UI Screen(P. 336)**
- 3 Select [Security Settings] ▶ [Key and Certificate Settings].**
- 4 Click [Generate Key].**

### NOTE:

#### Deleting a registered key and certificate

- Click [Delete] on the right of the key and certificate you want to delete ▶ click [OK].
- A key and certificate cannot be deleted if it is currently used for some purpose, such as when "[TLS]" is displayed under [Key Usage]. In this case, disable the function or replace the key and certificate before deleting it.

- 5 Select [Key and Certificate Signing Request (CSR)] and click [OK].**
- 6 Specify settings for the key and CSR.**



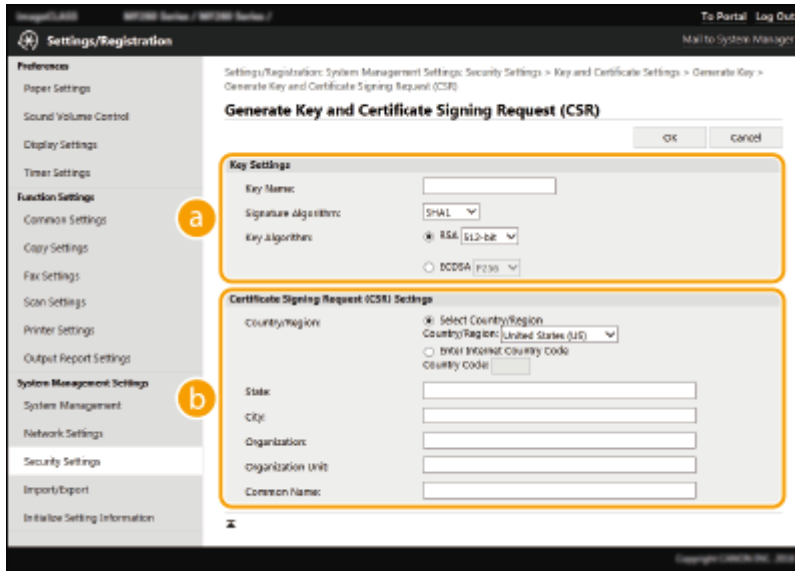

**a [Key Settings]**

**[Key Name]**

Enter alphanumeric characters for naming the key. Set a name that will be easy for you to find later in a list.

**[Signature Algorithm]**

Select the signature algorithm from the drop-down list.

**[Key Algorithm]**

Select the key generation algorithm from [RSA] or [ECDSA], then select the key length from the drop-down list. In any case, the larger the number for the key length, the slower the communication. However, the security is tighter.

**NOTE:**

- When [SHA384] or [SHA512] is selected in [Signature Algorithm], [512-bit] cannot be selected as the key length when [RSA] is selected in [Key Algorithm].

**b [Certificate Signing Request (CSR) Settings]**

**[Country/Region]**

Click the [Select Country/Region] radio button and select the country/region from the drop-down list. You can also click the [Enter Internet Country Code] radio button and enter a country code, such as "US" for the United States.

**[State]/[City]**

Enter alphanumeric characters for the location as necessary.

**[Organization]/[Organization Unit]**

Enter alphanumeric characters for the organization name as necessary.

**[Common Name]**

Enter alphanumeric characters for the common name of the certificate as necessary. "Common Name" is often abbreviated as "CN."

**7 Click [OK].**

- Generating a key and CSR may take some time.

**8 Click [Store in File].**

- A dialog box for storing the file appears. Choose where to store the file and click [Save].

⇒ The CSR file is stored on the computer.

## 9 Attach the stored file and submit the application to the certification authority.

### Registering a Certificate to a Key

The key with the CSR generated cannot be used until the certificate issued from the certificate authority based on the CSR is registered in the key. Once the certification authority has issued the certificate, register it using the procedure below.

- 1 Start the Remote UI and log in to System Manager Mode. ▶ Starting Remote UI(P. 335)
- 2 Click [Settings/Registration] on the Portal page. ▶ Remote UI Screen(P. 336)
- 3 Select [Security Settings] ▶ [Key and Certificate Settings].
- 4 Click [Key Name] or [Certificate] required to register the certificate.

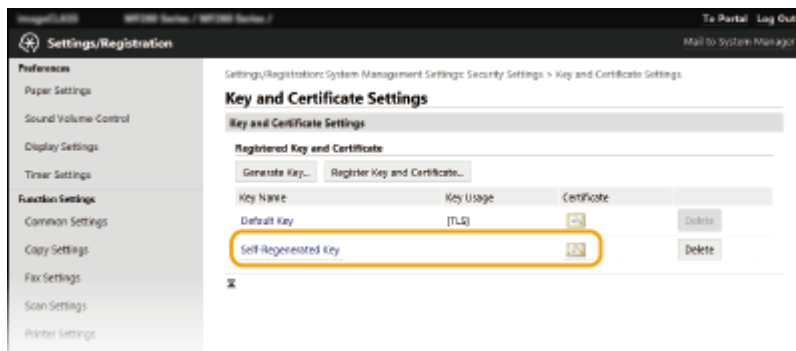

- 5 Click [Register Certificate].
- 6 Click [Browse], specify the file for the certificate signing request, and click [Register].

#### LINKS

- ▶ Configuring the Key and Certificate for TLS(P. 308)
- ▶ Generating the Key and Certificate for Network Communication(P. 310)
- ▶ Registering the Key and Certificate for Network Communication(P. 316)

# Registering the Key and Certificate for Network Communication

2KUU-06F

You can obtain the key and certificate, and the CA certificate from a certification authority (CA) for use with the machine. Install and register the obtained key and certificate file and CA certificate file in this machine using Remote UI. Check the key and certificate, and CA certificate conditions that are required for the machine in advance ( ▶ **Management Functions(P. 545)** ).



## NOTE

- For more information about the basic operations to be performed when setting the machine from the Remote UI, see ▶ **Setting Up Menu Options from Remote UI(P. 344)** .

- 1 Start the Remote UI and log in to System Manager Mode. ▶ Starting Remote UI(P. 335)**
- 2 Click [Settings/Registration] on the Portal page. ▶ Remote UI Screen(P. 336)**
- 3 Select [Security Settings] ▶ [Key and Certificate Settings] or [CA Certificate Settings].**
  - Click [Key and Certificate Settings] to install a key and certificate, or [CA Certificate Settings] to install a CA certificate.
- 4 Click [Register Key and Certificate] or [Register CA Certificate].**

## NOTE:

### Deleting a registered key and certificate or CA certificate

- Click [Delete] on the right of the key and certificate or CA certificate you want to delete ▶ click [OK]. You cannot delete the preinstalled CA certificates.
- A key and certificate cannot be deleted if it is currently used for some purpose, such as when "[TLS]" is displayed under [Key Usage]. In this case, disable the function or replace the key and certificate before deleting it.

### Disabling or enabling the preinstalled CA certificates

- Click [Disable] on the right of the preinstalled CA certificate you want to disable. To enable the certificate again, click [Enable] on the right of the certificate.

- 5 Click [Install].**

**NOTE:**

**Deleting the key and certificate file or CA certificate file**

- Click [Delete] on the right of the file you want to delete ► click [OK].

**6 Click [Browse], specify the file to install, and click [Start Installation].**

► The key and certificate file or the CA certificate file is installed on the machine from a computer.

**7 Register the key and certificate or CA certificate.**

**■ Registering a key and certificate**

- 1 Click [Register] on the right of the key and certificate file you want to register.
- 2 Enter the name of the key and password.

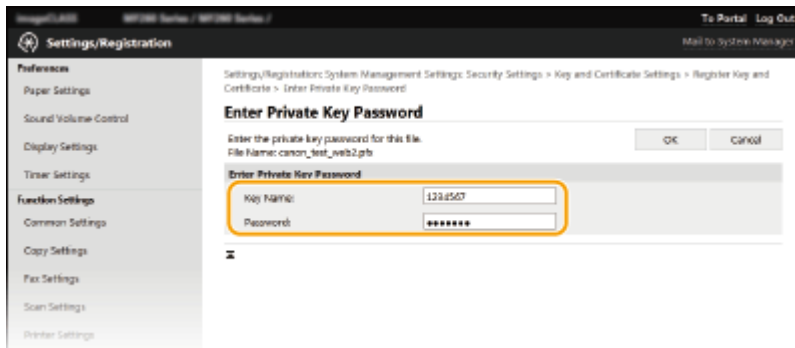

**[Key Name]**

Enter alphanumeric characters for the name of the key to be registered.

**[Password]**

Enter alphanumeric characters for the password of the private key set for the file to be registered.

- 3 Click [OK].

**■ Registering a CA certificate**

Click [Register] on the right of the CA certificate file you want to register.

**LINKS**

- ▶ **Configuring the Key and Certificate for TLS(P. 308)**
- ▶ **Generating the Key and Certificate for Network Communication(P. 310)**
- ▶ **Configuring IEEE 802.1X Authentication Settings(P. 318)**

## Configuring IEEE 802.1X Authentication Settings

2KUU-06H

The machine can connect to an 802.1X network as a client device. A typical 802.1X network consists of a RADIUS server (authentication server), LAN switch (authenticator), and client devices with authentication software (supplicants). If a device tries to connect to the 802.1X network, the device must go through user authentication in order to prove that the connection is made by an authorized user. Authentication information is sent to and checked by a RADIUS server, which permits or rejects communication to the network depending on the authentication result. If authentication fails, a LAN switch (or an access point) blocks access from the outside of the network.

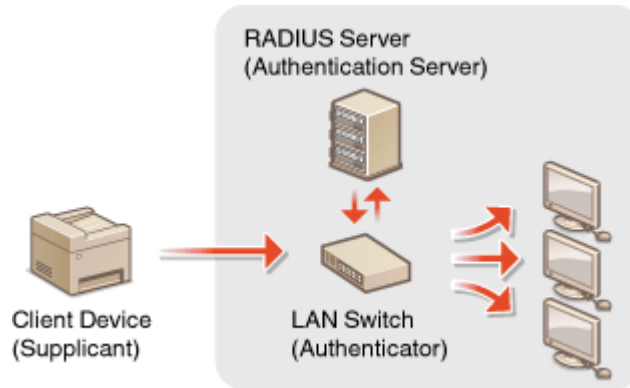

### IEEE 802.1X Authentication Method

Select the authentication method from the options below. If necessary, install or register a key and certificate or a CA certificate before configuring IEEE 802.1X authentication ( [▶Registering the Key and Certificate for Network Communication\(P. 316\)](#) ).

#### ■ TLS

The machine and the authentication server authenticate each other by mutually verifying their certificates. A key and certificate issued by a certification authority (CA) is required for the client authentication (when authenticating the machine). For the server authentication, a CA certificate installed via the Remote UI can be used in addition to a CA certificate preinstalled in the machine.

#### ■ TTLS

This authentication method uses a user name and password for the client authentication and a CA certificate for the server authentication. MSCHAPv2 or PAP can be selected as the internal protocol. TTLS can be used with PEAP at the same time. Enable TLS for the Remote UI before configuring this authentication method ( [▶Configuring the Key and Certificate for TLS\(P. 308\)](#) ).

#### ■ PEAP

The required settings are almost the same as those of TTLS. MSCHAPv2 is used as the internal protocol. Enable TLS for the Remote UI before configuring this authentication method ( [▶Configuring the Key and Certificate for TLS\(P. 308\)](#) ).

## NOTE

- For more information about the basic operations to be performed when setting the machine from the Remote UI, see [▶Setting Up Menu Options from Remote UI\(P. 344\)](#) .

- 1 Start the Remote UI and log in to System Manager Mode. [▶Starting Remote UI\(P. 335\)](#)

- 2 Click [Settings/Registration] on the Portal page. ▶ Remote UI Screen(P. 336)
- 3 Select [Network Settings] ▶ [IEEE 802.1X Settings].
- 4 Click [Edit].
- 5 Select the [Use IEEE 802.1X] check box, and enter the login name in the [Login Name] text box.

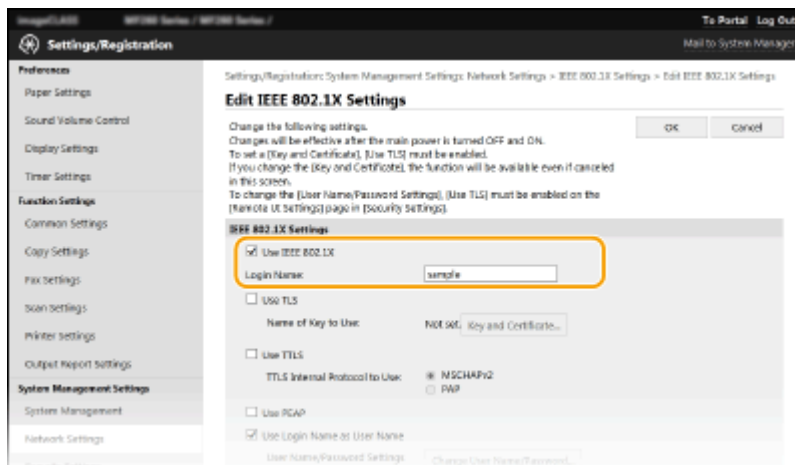

**[Use IEEE 802.1X]**

Select the check box to enable IEEE 802.1X authentication.

**[Login Name]**

Enter alphanumeric characters for a name (EAP identity) that is used for identifying the user.

- 6 Configure the required settings according to the specified authentication method.



■ **Setting TLS**

- 1 Select the [Use TLS] check box and click [Key and Certificate].
  - You cannot use TLS with TTLS or PEAP.
- 2 Click [Register Default Key] on the right of the key and certificate you want to use for the client authentication.

**NOTE:**

**Viewing details of a certificate**

- You can check the details of the certificate or verify the certificate by clicking the corresponding text link under [Key Name], or the certificate icon.

**■ Setting TTLS/PEAP**

- 1 Select the [Use TTLS] or [Use PEAP] check box.

**NOTE:**

**Internal protocol for TTLS**

- You can select MSCHAPv2 or PAP.

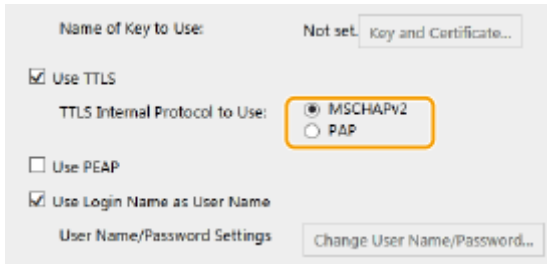

- 2 Click [Change User Name/Password].

- To specify a user name other than the login name, clear the [Use Login Name as User Name] check box. Select the check box if you want to use the login name as the user name.

- 3 Set the user name/password.

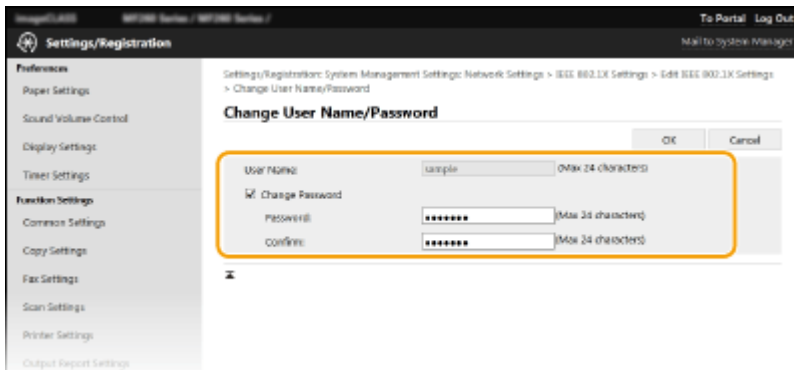

**[User Name]**

Enter alphanumeric characters for the user name.

**[Change Password]**

To set or change the password, select the check box and enter alphanumeric characters for the new password both in the [Password] and [Confirm] text boxes.

- 4 Click [OK].

- 7 Click [OK].

- 8 Restart the machine.

- Turn OFF the machine, wait for at least 10 seconds, and turn it back ON.

**NOTE**

### Using the operation panel

- You can also enable or disable IEEE 802.1X authentication from the <Menu> screen. [▶<IEEE 802.1X Settings>\(P. 372\)](#)

### LINKS

---

- [▶Configuring the Key and Certificate for TLS\(P. 308\)](#)



## Restricting the Machine's Functions

2KUU-06J

Some of the functions of the machine may rarely be used or provide opportunities for misuse. For security purposes, the machine can be set to limit its capabilities by partially or completely disabling these functions.

### Restricting Access to Address Book and Sending Functions

You can specify the PIN in the Address Book to disable a general user from modifying data or limit destinations that can be specified for fax sending. You can also disable a user from collectively sending a fax to multiple destinations (Sequential Broadcast). **Restricting Access to Address Book and Sending Functions(P. 324)**



### Restricting USB Functions

The USB connection allows an easy connection with peripheral devices, but it may cause a security risk such as an information leakage. You can restrict a USB connection with a computer. **Restricting USB Functions(P. 331)**



### Disabling HTTP Communication

When not performing operations via the network, for example, when using the machine via USB connection, you can disable HTTP communication to prevent a hacking via the HTTP port. **Disabling HTTP Communication(P. 332)**



### Disabling Remote Management

When not using Remote UI, you can disable functions to prevent an unauthorized remote operation via Remote UI. **Disabling Remote UI(P. 333)**



# Restricting Access to Address Book and Sending Functions

2KUU-06K

Some cases of information leakage can be prevented by limiting the available fax and e-mail destinations to those registered in the Address Book, or by setting a PIN for the Address Book so that unauthorized users cannot add or edit Address Book entries. You can also avoid sending documents to unintended recipients if the machine is set to ask you to enter the fax number twice for confirmation.



- ▶ **Restricting Use of the Address Book(P. 325)**
- ▶ **Limiting Available Destinations(P. 327)**
- ▶ **Restricting the Fax Sending Functions(P. 329)**

# Restricting Use of the Address Book



The Address Book can be set to require users to enter a PIN in order to add new entries to the Address Book or edit existing entries. Setting a PIN to the Address Book can reduce the risk of documents being sent to unintended recipients because changes to the Address Book can only be made by users who know the PIN.

**1** Select <Menu> in the Home screen. [▶Home Screen\(P. 111\)](#)

**2** Select <System Management Settings>.

- If the screen for entering a PIN appears, enter the correct PIN. [▶Setting the System Manager PIN\(P. 293\)](#)

**3** Select <Restrict TX Function> ▶ <Address Book PIN>.

**4** Specify the PIN.

- Enter the number, and select <Apply>.
- The Confirm screen is displayed. Enter the PIN once again to confirm.

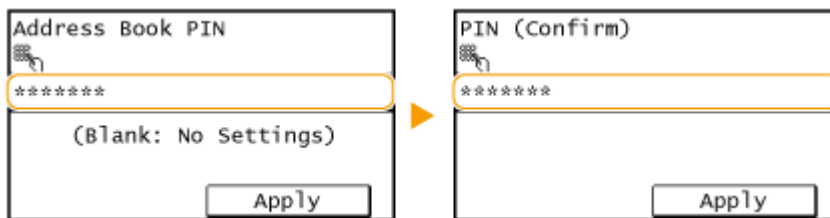

## NOTE:

- You cannot set a PIN that consists only of zeros, such as "00" or "0000000".
- To cancel the PIN setting, clear the information you entered by pressing **C** and select <Apply> with the field blank.

## NOTE

In addition to setting the Address Book PIN, you can further enhance security by performing the following operations:

- Restricting the addition of new destinations, see [▶Restricting New Destinations that Can Be Specified\(P. 327\)](#) .
- Disabling the PC fax function, see [▶Restricting Fax Sending from a Computer\(P. 329\)](#) .

## LINKS

[▶Registering Destinations\(P. 161\)](#)

- ▶ **Registering Destinations from Remote UI(P. 347)**
- ▶ **Configuring Basic E-Mail Settings(P. 79)**
- ▶ **Setting a Shared Folder as a Save Location(P. 86)**

## Limiting Available Destinations



By limiting destinations that can be specified to those registered in the Address Book, you can reduce the possibility of specifying unintended destinations and prevent users from leaking information. You can configure the setting to display the confirmation screen to prevent the user from misdialing when specifying a coded dial number in the Address Book.

- ▶ **Restricting New Destinations that Can Be Specified(P. 327)**
- ▶ **Disabling Use of Previously Used Destinations(P. 327)**
- ▶ **Displaying Destinations in Address Book(P. 327)**

### Restricting New Destinations that Can Be Specified

Restrict destinations that can be specified when sending faxes or scanned documents to "those already registered in the Address Book," "those registered as One-Touch Dial," or "those previously used." When this function is enabled, the machine prohibits users from entering destinations using the numeric keys, adding new entries to the Address Book, and editing the existing Address Book entries.



<Menu> ▶ <System Management Settings> ▶ <Restrict TX Function> ▶ <Restrict New Destinations> ▶ <On> ▶

### IMPORTANT

- This function does not limit the available destinations for PC faxing. ▶ **Restricting Fax Sending from a Computer(P. 329)**

### Disabling Use of Previously Used Destinations

Prohibits the specification of destinations from the transmission records. Using this restriction prevents destinations being selected from the transmission records for "Send Fax," "Scan and Send as E-mail" and "Scan and Save to Shared Folder."



<Menu> ▶ <System Management Settings> ▶ <Restrict TX Function> ▶ <Restrict Resending from Log> ▶ <On> ▶

### Displaying Destinations in Address Book

When using One-Touch buttons or coded dial numbers to specify destinations, you need to precisely remember whose destination (or what group) is registered in what coded dial number. If you do not remember all these numbers accurately, you may send your documents to unintended destinations. You can avoid sending data to unintended recipients by configuring the machine to display the details of the One-Touch buttons or coded dial number you selected/entered as a sending destination on the screen before you send documents to that destination.



<Menu> ▶ <System Management Settings> ▶ <Restrict TX Function> ▶ <One-Touch/Coded Dial TX Confirmation> ▶ <On> ▶ 

## LINKS

---

- ▶ **Sending Data by E-Mail/Saving Data to a Shared Folder(P. 239)**
- ▶ **Recalling Previously Used Settings for Sending/Saving (Recall Settings)(P. 257)**
- ▶ **Restricting Use of the Address Book(P. 325)**
- ▶ **Restricting the Fax Sending Functions(P. 329)**

## Restricting the Fax Sending Functions

2KUU-0AC

You can set various restrictions for sending faxes, which can prevent information leakage to third parties or sending documents to unintended destinations.



- ▶ **Confirming the Entered Fax Number(P. 329)**
- ▶ **Restricting Fax Sending from a Computer(P. 329)**
- ▶ **Restricting Sequential Broadcasts(P. 329)**

### Confirming the Entered Fax Number

You can configure the setting to display the confirmation screen to prevent the user from misdialing when entering a destination fax number using the numeric keys.

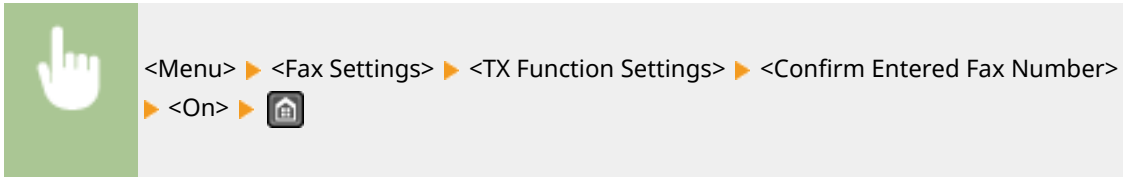

### Restricting Fax Sending from a Computer

You can prohibit users from PC faxing (faxing from a computer).



### Restricting Sequential Broadcasts

You can prohibit a function that collectively sends a fax to multiple destinations (Sequential Broadcast).

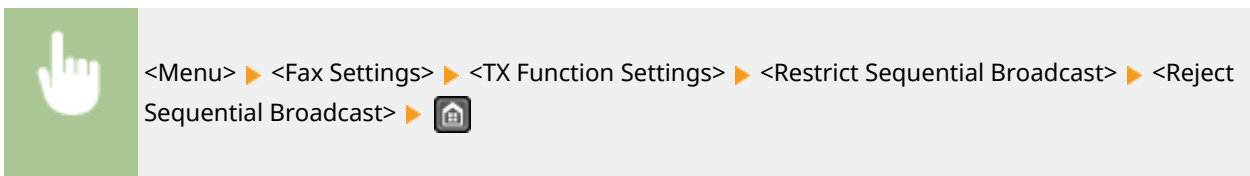



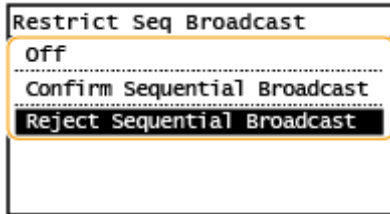

**<Off>**

Enables sequential broadcasting.

**<Confirm Sequential Broadcast>**

Displays the confirmation screen when sending a fax via sequential broadcasting.

**<Reject Sequential Broadcast>**

Disables sequential broadcasting.

## LINKS

---

- ▶ **Basic Operations for Sending Faxes(P. 195)**
- ▶ **Recalling Previously Used Settings for Sending (Recall Settings)(P. 208)**
- ▶ **Sending Faxes from Your Computer (PC Fax)(P. 219)**
- ▶ **Restricting Use of the Address Book(P. 325)**
- ▶ **Limiting Available Destinations(P. 327)**

## Restricting USB Functions

2KUU-06Y

USB is a convenient way of connecting peripheral devices and storing or relocating data, but USB can also be a source of information leakage if it is not properly managed. This section describes how to restrict connection via the USB port of the machine.



### Restricting the USB Connection with a Computer(P. 331)

#### Restricting the USB Connection with a Computer

You can disable the USB port that is used for connecting the machine to a computer. If this port is disabled, the machine cannot communicate with a computer via USB.



<Menu> (  ) ▶ <System Management Settings> ▶ <Use as USB Device> ▶ <Off> ▶ Restart the machine

## Disabling HTTP Communication

2KUU-070

HTTP is used for communications over the network, such as when you access the machine via the Remote UI. If you are using a USB connection or are otherwise not using HTTP, you can disable HTTP to block malicious third-party intrusions via the unused HTTP port.



### IMPORTANT

- Disabling HTTP disables some of the network capabilities, such as the Remote UI, WSD printing, and printing with Google Cloud Print.



<Menu> (  ) ▶ <Network Settings> ▶ <TCP/IP Settings> ▶ <Use HTTP> ▶ <Off> ▶ <Yes>

### LINKS

- ▶ [Configuring Printing Protocols and WSD Functions\(P. 42\)](#)
- ▶ [Using Google Cloud Print\(P. 286\)](#)
- ▶ [Changing Port Numbers\(P. 305\)](#)
- ▶ [Managing the Machine from a Computer \(Remote UI\)\(P. 334\)](#)

## Disabling Remote UI

2KUU-071

The Remote UI is useful because the machine settings can be specified by using a Web browser on a computer. To use the Remote UI, the machine must be connected to a computer over the network. If the machine is connected to a computer via USB, or if you do not need to use the Remote UI, you might want to disable the Remote UI to reduce the risk of having your machine controlled remotely over the network by malicious third parties.





<Menu> (  ) ▶ <System Management Settings> ▶ <Remote UI Settings> ▶ <Use Remote UI>  
▶ <Off>

### LINKS

- ▶ [Disabling HTTP Communication\(P. 332\)](#)
- ▶ [Managing the Machine from a Computer \(Remote UI\)\(P. 334\)](#)

## Managing the Machine from a Computer (Remote UI)

---

2KUU-072

Using a Web browser to operate the machine remotely, you can check the documents waiting to be printed or the status of the machine. You can also make various settings. You can do this without leaving your desk, making system management easier. For more information about the system requirements for the Remote UI, see **System Environment(P. 546)** .

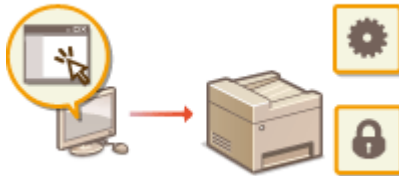

### Functions of the Remote UI

- ▶ **Checking the Status and Logs(P. 338)**
- ▶ **Setting Up Menu Options from Remote UI(P. 344)**
- ▶ **Registering Destinations from Remote UI(P. 347)**
- ▶ **Saving/Loading Address Book from Remote UI(P. 351)**

### Basics of the Remote UI

- ▶ **Starting Remote UI(P. 335)**

# Starting Remote UI

2KUU-073

To operate remotely, you need to input the IP address of the machine into a Web browser and start the Remote UI. Check the IP address set to the machine in advance ( [▶Viewing Network Settings\(P. 38\)](#) ). If you have any questions, ask your Network Administrator.

## 1 Start the Web browser.

## 2 Enter "http://<the IP address of the machine>/" in the address field, and press the [ENTER] key.

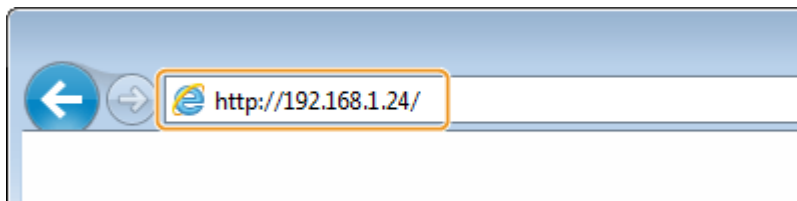

- If you want to use an IPv6 address, enclose the IPv6 address with brackets (example: http://[fe80::2e9e:fcff:fe4e:dbce]/).

### NOTE:

#### If a security alert is displayed

- A security alert may be displayed when the Remote UI communication is encrypted ( [▶Configuring the Key and Certificate for TLS\(P. 308\)](#) ). When certificate settings or TLS settings have no errors, continue browsing the Web site.

## 3 Log in to the Remote UI.

### ■When a System Manager PIN is not set

Select [System Manager Mode] or [General User Mode].

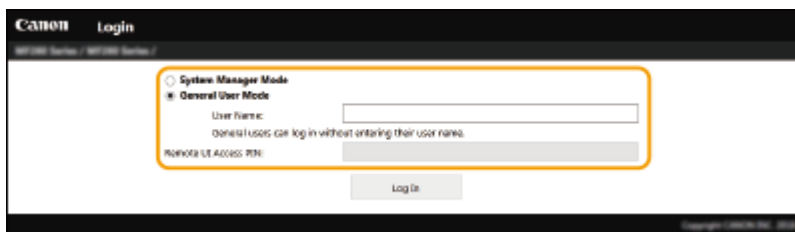

#### [System Manager Mode]

You can perform all the Remote UI operations and settings.

#### [General User Mode]

You can check the status of documents or the machine, and you can also change some of the settings. When you want to check if a specific document of yours is in the print queue or cancel the printing of a document of yours in the print queue, enter the user name of the document in [User Name]. The user name is automatically set to print documents based on information such as your computer name or computer login name.

#### [Remote UI Access PIN]

If [Remote UI Access PIN] is set, enter the PIN. [▶Setting a Remote UI PIN\(P. 295\)](#)

**■ When a System Manager PIN is set**

Enter the appropriate PIN in [System Manager PIN] to log in to System Manager Mode. **▶ Setting the System Manager PIN(P. 293)**

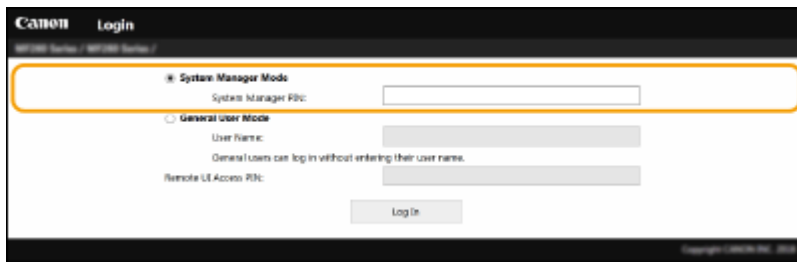

**4 Click [Log In].**

⇒ The Portal page (main page) will be displayed. **▶ Remote UI Screen(P. 336)**

**Remote UI Screen**

When you log in to the Remote UI, the following Portal page appears. This section describes the items displayed on the Portal page and the basic operations.

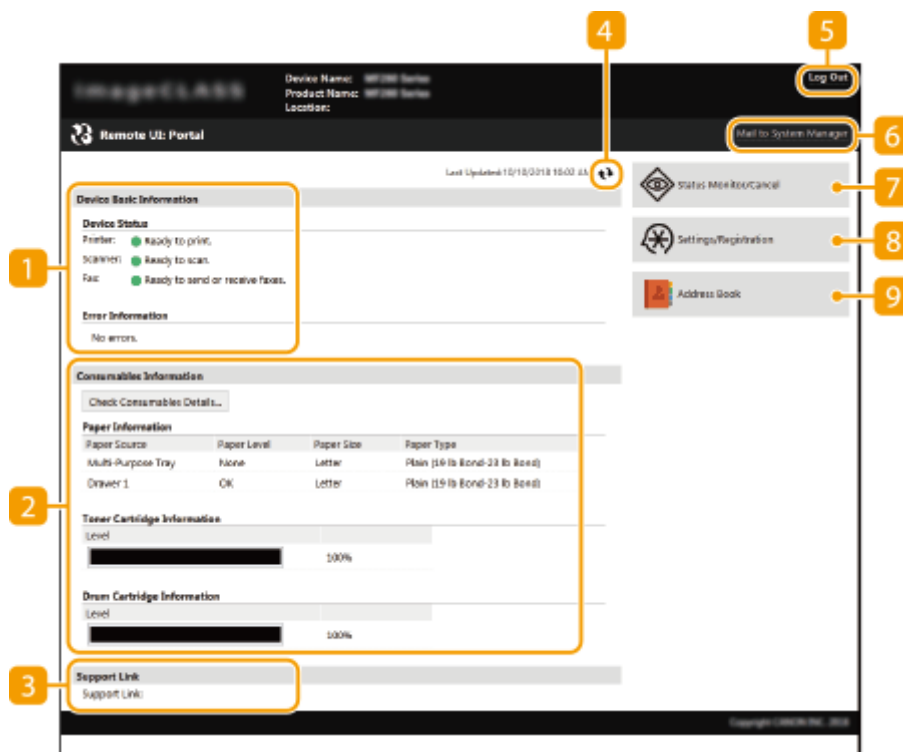

**1 [Device Basic Information]**

Displays the current status of the machine and error information. If an error has occurred, the link to the Error Information page will be displayed.

**2 [Consumables Information]**

Displays information about consumables.

### 3 [Support Link]

Displays the support link specified in [Device Information] under [System Management].

### 4 Refresh Icon

Refreshes the currently displayed page.

### 5 [Log Out]

Logs off from the Remote UI. The Login page will be displayed.

### 6 [Mail to System Manager]

Displays a window for creating an e-mail to the system manager specified in [System Manager Information] under [System Management].

### 7 [Status Monitor/Cancel]

Displays the [Status Monitor/Cancel] page. For any of the waiting documents, you can check the status/history or cancel the processing.

### 8 [Settings/Registration]

Displays [Settings/Registration] page. When you have logged in to System Manager Mode, you can change the settings items and save/load the registered data. ▶ **Setting Up Menu Options from Remote UI(P. 344)**

### 9 [Address Book]

Displays the coded dial numbers and the One-Touch Dial list registered in the Address Book. You can also register or edit the Address Book when you have logged in to System Manager Mode. ▶ **Registering Destinations from Remote UI(P. 347)**



## Checking the Status and Logs

2KUU-074

- ▶ Checking Current Status of Print Documents(P. 338)
- ▶ Checking the Status of Received Faxes(P. 339)
- ▶ Checking History of Documents(P. 339)
- ▶ Checking Error Information(P. 339)
- ▶ Checking Consumables(P. 340)
- ▶ Checking Maximum Print Speed(P. 340)
- ▶ Checking System Manager Information(P. 341)
- ▶ Checking Print Total Counter(P. 341)
- ▶ Checking History of Cartridge(P. 342)
- ▶ Checking Eco Information(P. 342)

### NOTE

- A file name of a document may not be displayed in full. The printed application name may be added to the file name.

## Checking Current Status of Print Documents

The list of the documents currently printing or waiting to be printed is displayed.



Log in to the Remote UI ( ▶ **Starting Remote UI(P. 335)** ) ▶ [Status Monitor/Cancel] ▶ [Job Status]

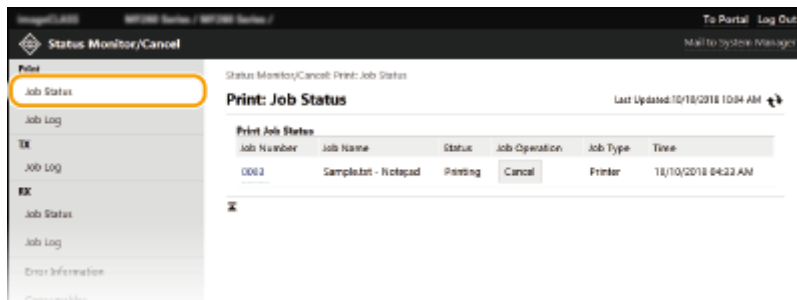

- You can delete a document job by clicking [Cancel].

### NOTE

- If you logged in to System Manager Mode, all the print documents currently printing and waiting to be printed will be listed.
- If you entered your user name when you logged in to General User Mode, your user name will only be displayed on the documents that you printed.
- Click [Job Number] on the paused documents to display detailed information. You can check the user name and the page count of the printed document.

## Checking the Status of Received Faxes

You can check the logs of received fax documents. You can also click [Delete] for a received fax document to delete it.



Log in to the Remote UI ( [▶Starting Remote UI\(P. 335\)](#) ) ▶ [Status Monitor/Cancel] ▶ [Job Status] under [RX]

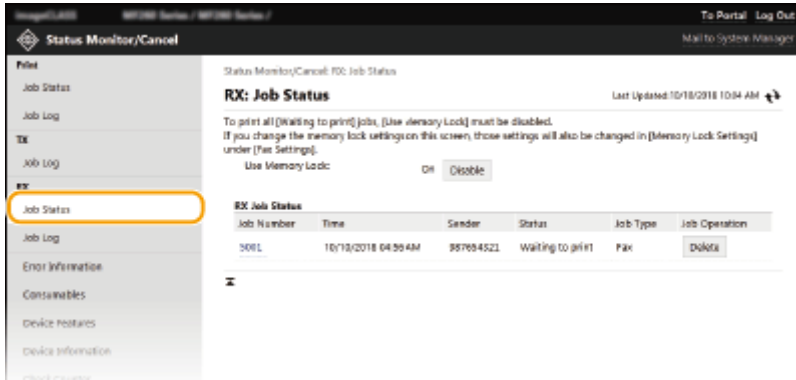

### NOTE

- To perform the following operations, you need to log in first in System Manager Mode, click [Enable], and set [Use Memory Lock] to [On].
  - Click [Job Number] to display detailed information and preview of a document waiting to be printed.

## Checking History of Documents

The history of print, sending faxes/e-mails (TX), or receiving faxes (RX) is displayed.



Log in to the Remote UI ( [▶Starting Remote UI\(P. 335\)](#) ) ▶ [Status Monitor/Cancel] ▶ [Job Log]

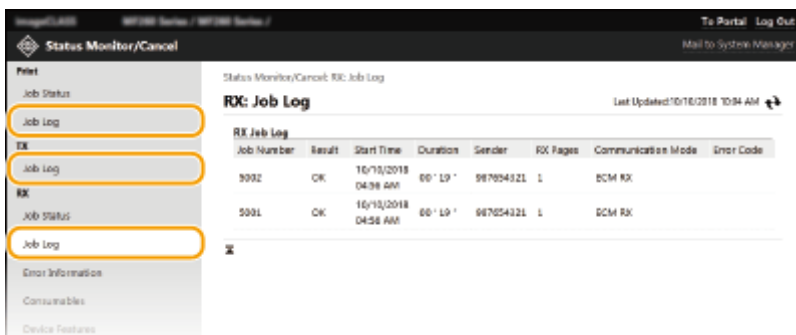

## Checking Error Information

When an error occurs, this page will be displayed by clicking the message displayed under [Error Information] on the Portal page (main page). [▶Remote UI Screen\(P. 336\)](#)



Log in to the Remote UI ( ▶ **Starting Remote UI(P. 335)** ) ▶ [Status Monitor/Cancel] ▶ [Error Information]

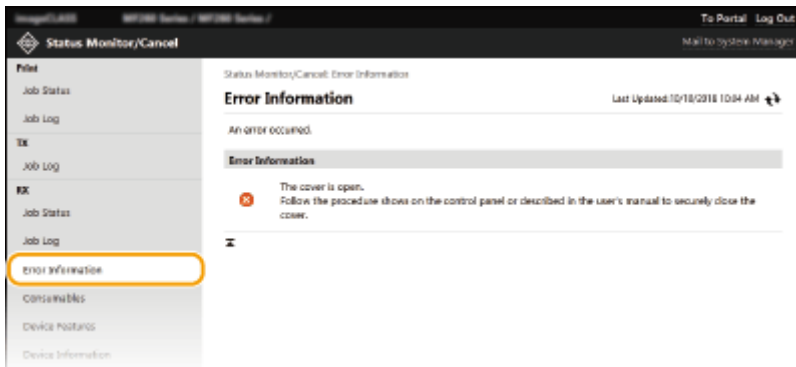

## Checking Consumables

Paper size and paper type for the paper source, toner cartridge model number, etc. are displayed. You can also click [Check Consumables Details] in the Portal page (main page) to display this page ( ▶ **Remote UI Screen(P. 336)** ).



Log in to the Remote UI ( ▶ **Starting Remote UI(P. 335)** ) ▶ [Status Monitor/Cancel] ▶ [Consumables]

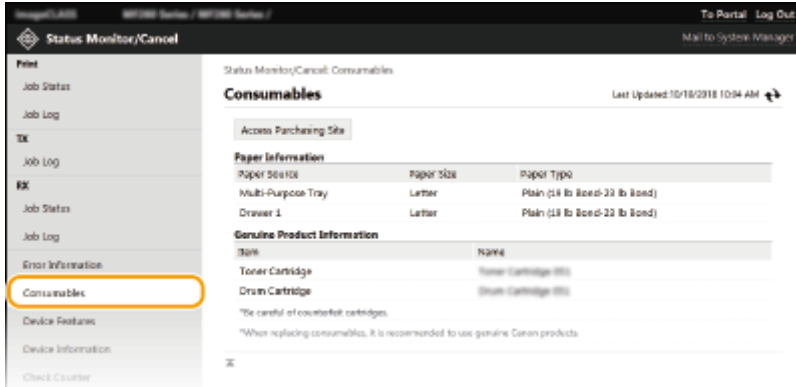

## Checking Maximum Print Speed

The maximum print speed is displayed.



Log in to the Remote UI ( ▶ **Starting Remote UI(P. 335)** ) ▶ [Status Monitor/Cancel] ▶ [Device Features]

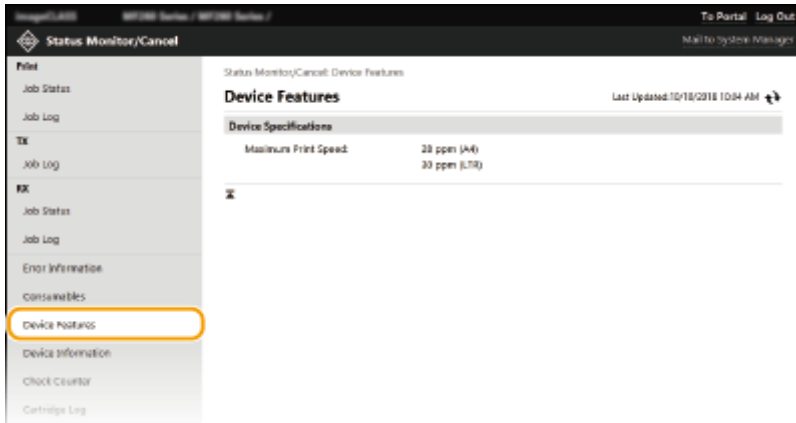

## Checking System Manager Information

Information about the machine and the system manager is displayed. This information is set in [System Management] on the [Settings/Registration] page.



Log in to the Remote UI ( ▶ **Starting Remote UI(P. 335)** ) ▶ [Status Monitor/Cancel] ▶ [Device Information]

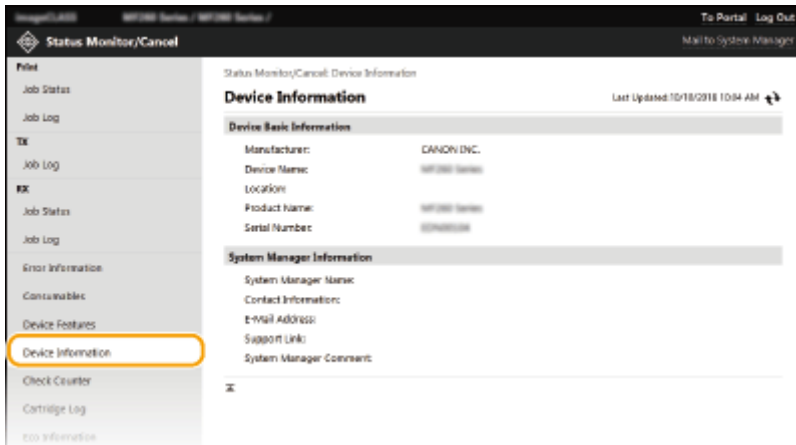

## Checking Print Total Counter

The total number of pages that have been printed by the copy, print, and fax functions is displayed.



Log in to the Remote UI ( ▶ **Starting Remote UI(P. 335)** ) ▶ [Status Monitor/Cancel] ▶ [Check Counter]

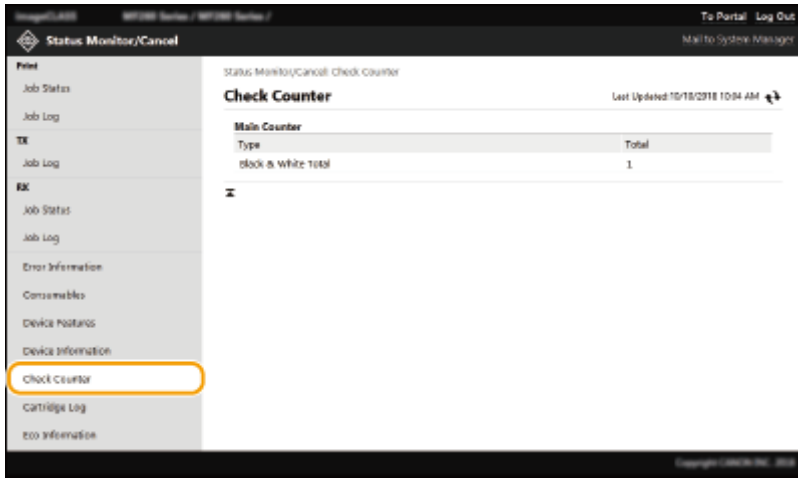

## Checking History of Cartridge

You can check the usage logs of the toner cartridge or the drum cartridge. The display can be changed to either the toner cartridge or the drum cartridge.



Log in to the Remote UI ( ▶ **Starting Remote UI(P. 335)** ) ▶ [Status Monitor/Cancel] ▶ [Cartridge Log]

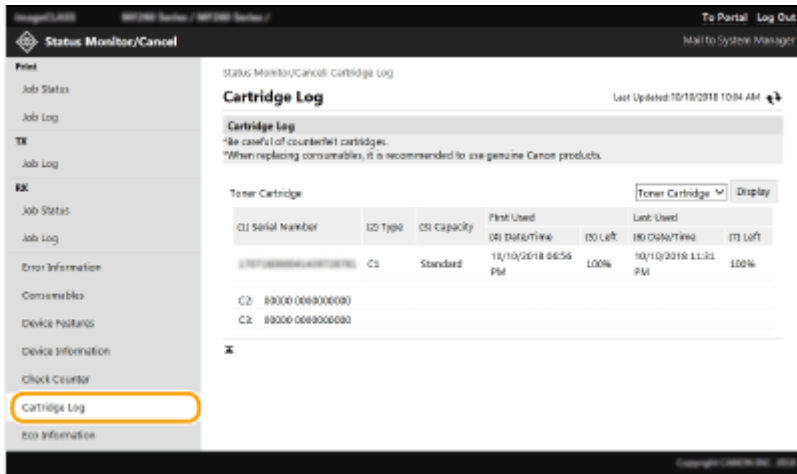

## Checking Eco Information

You can check information such as the number of printouts per month and amount of consumed power.



Log in to the Remote UI ( ▶ **Starting Remote UI(P. 335)** ) ▶ [Status Monitor/Cancel] ▶ [Eco Information]

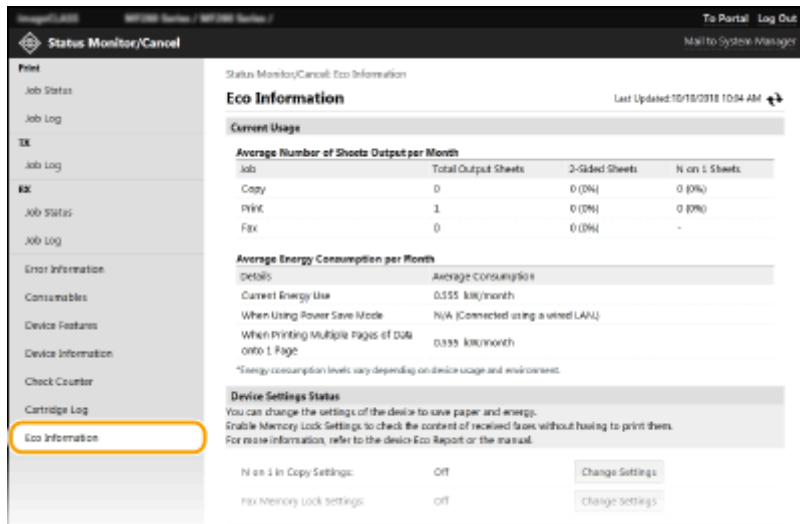

LINKS

▶ Remote UI Screen(P. 336)

# Setting Up Menu Options from Remote UI

2KUU-075

You can change the various machine settings by using the Remote UI. Most of the settings can be set also on the machine, but some settings can only be set using the Remote UI. This section describes the basic flow of changing the settings of the machine using the Remote UI.

## NOTE

- Some settings can only be changed when you have logged in to System Manager Mode.
- Some settings may require Settings operations that differ from the procedure described here.

- 1 Start the Remote UI. ▶Starting Remote UI(P. 335)**
- 2 Click [Settings/Registration] on the Portal page. ▶Remote UI Screen(P. 336)**
- 3 Click the setting you want to configure in the menu on the left side of the screen.**

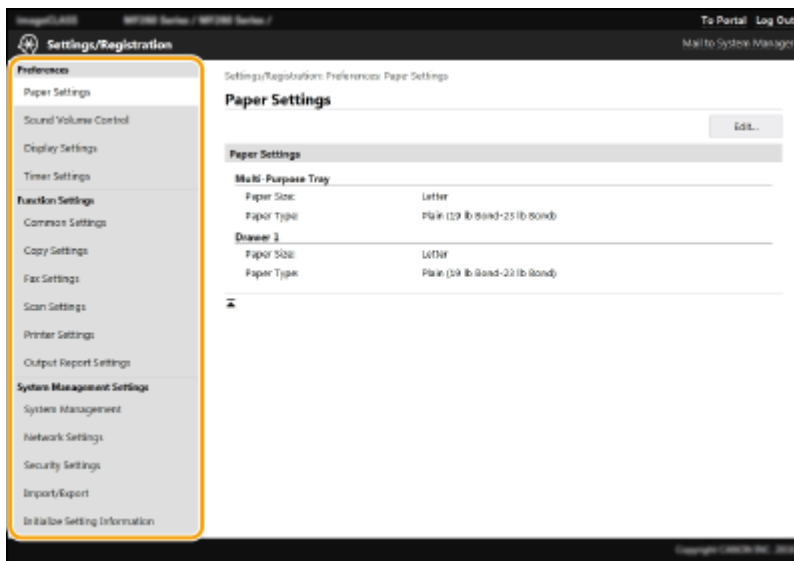

- 4 Click the link to display the desired page as necessary.**

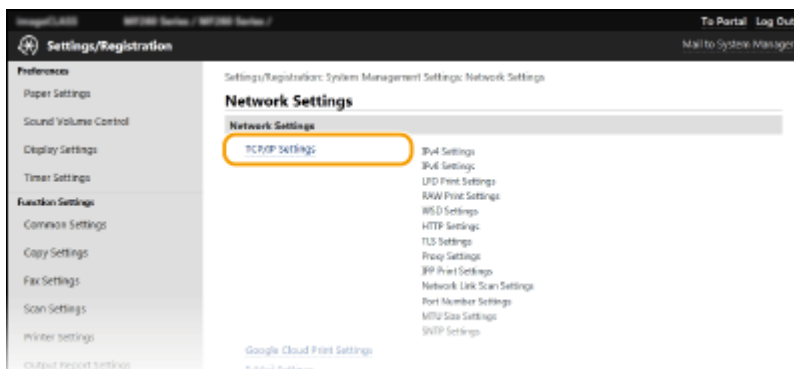

5 Click [Edit].

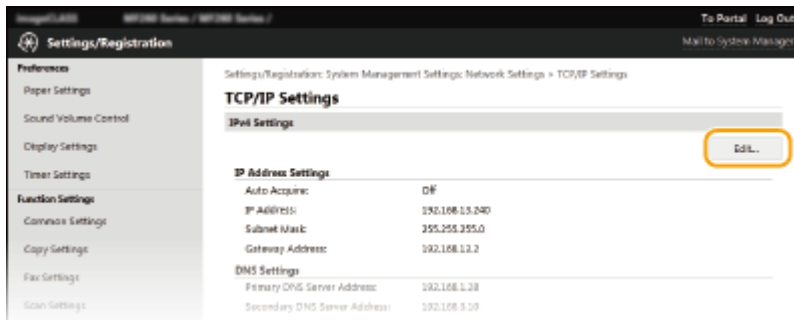

6 Specify the required settings.

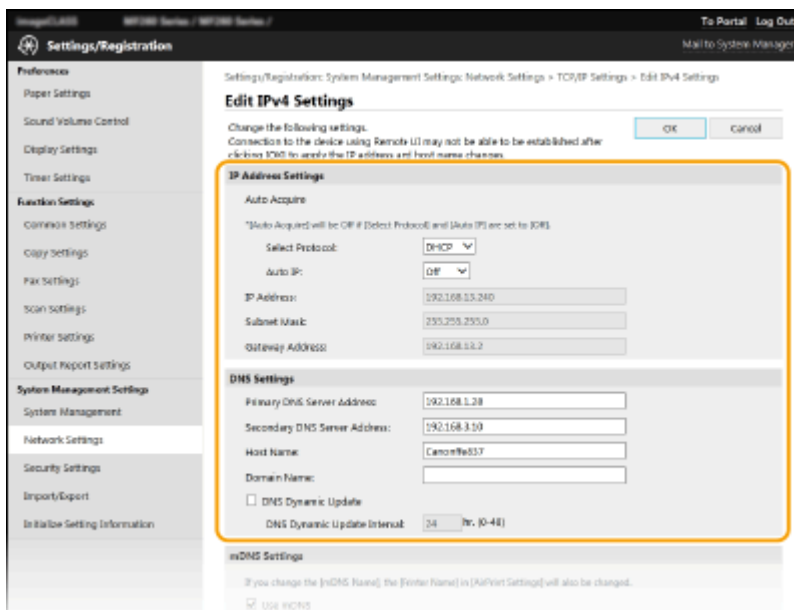

7 Click [OK].

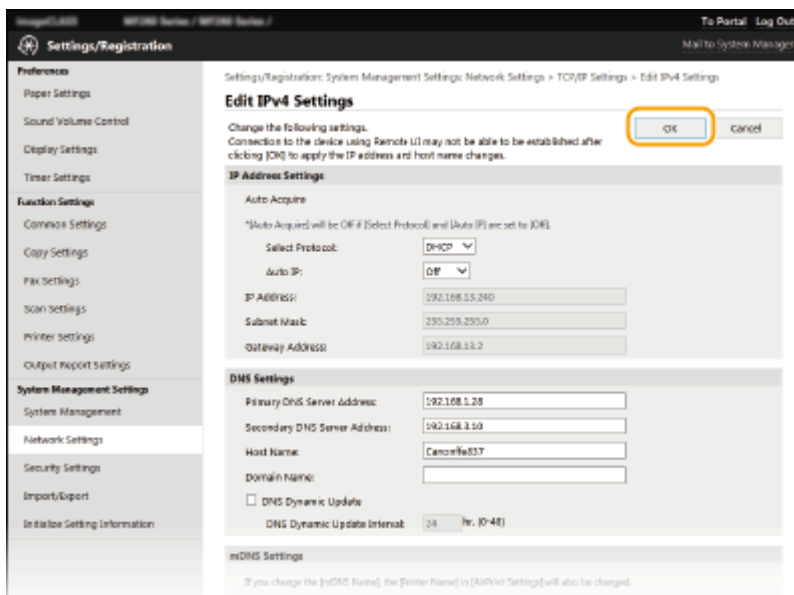



## 8 Restart the machine as necessary.

- Turn OFF the machine, wait for at least 10 seconds, and turn it back ON.

### NOTE:

- For information about whether you need to restart the machine, view the message on the edit screen.

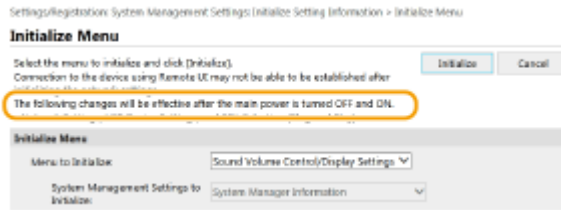

# Registering Destinations from Remote UI

2KUU-076

You can use the computer to register destinations in the Address Book of the machine and edit information of registered destinations. Specify the shared folder destination here.

## NOTE

You can change the settings only when you have logged in to System Manager Mode.

### 1 Start the Remote UI. ▶Starting Remote UI(P. 335)

### 2 Click [Address Book] on the Portal page. ▶Remote UI Screen(P. 336)

#### NOTE:

If the enter PIN page is displayed

The Address Book is protected by a PIN. Enter the [PIN] and click [OK].

### 3 Click [Coded Dial].

- You can also register destinations in One-Touch. In this case, click [One-Touch] instead of [Coded Dial]. ▶One-Touch Dial(P. 161)

### 4 Click the text link under [Number], [Type], or [Name] for an item named "Not Registered."

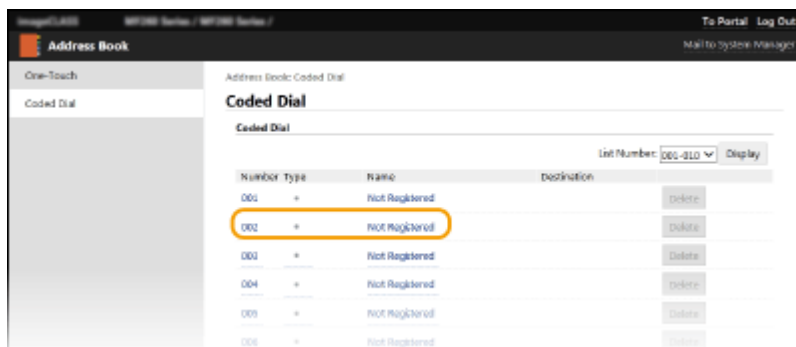

#### NOTE:

- You can edit a registered item by clicking the corresponding text link under [Number], [Type] or [Name].
- You can delete a registered item by clicking the corresponding [Delete] button.

### 5 Select [Destination Type to Register] and click [OK].

- To register the shared folder destination, select [File].

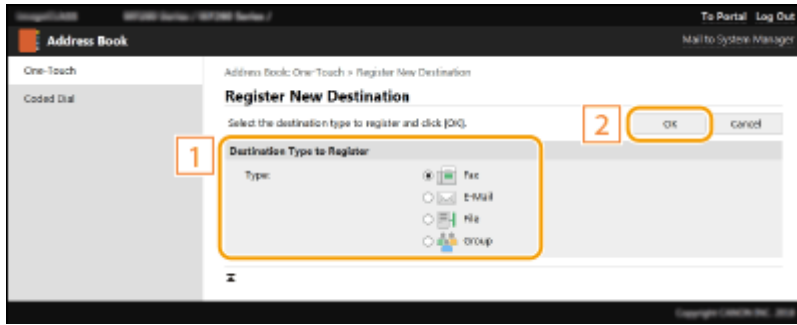

## 6 Specify the destination.

### ■ To register the fax destination

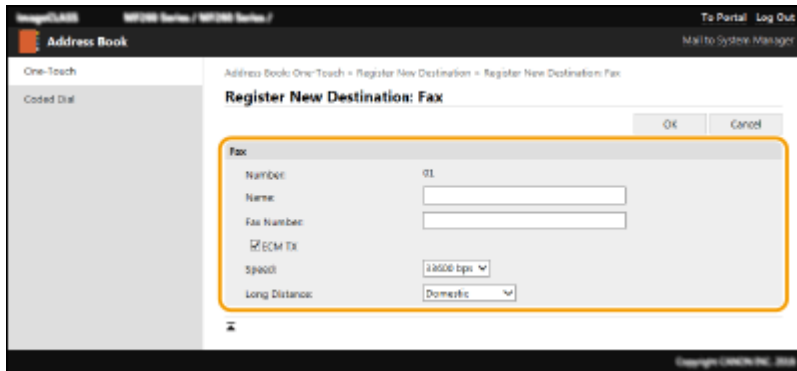

#### [Name]

Enter the name of the destination.

#### [Fax Number]

Enter the fax number of the destination.

#### [ECM TX]

Select the check box to make the following possible: if an error occurs in an image that is being sent, the error is checked and corrected to prevent an improper image from being sent.

#### [Speed]

If it takes time for transmissions to start, such as when there is a poor telephone connection, you can adjust the transmission start speed downward.

#### [Long Distance]

Specify [International (1)] to [International (3)] according to the transmission conditions when registering overseas fax numbers.

### NOTE:

- You can also specify [ECM TX] and [Speed] from <Fax Settings> ( ▶<Fax Settings>(P. 389) ) on the operation panel. However, settings made from <Addr. Book> are enabled for the detailed settings of destinations registered in the Address Book.

### ■ To register the e-mail destination

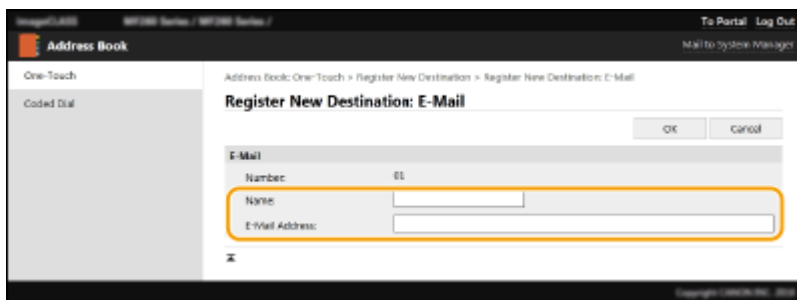

**[Name]**

Enter the name of the destination.

**[E-Mail Address]**

Enter the e-mail address of the destination.

■ **To register the shared folder destination**

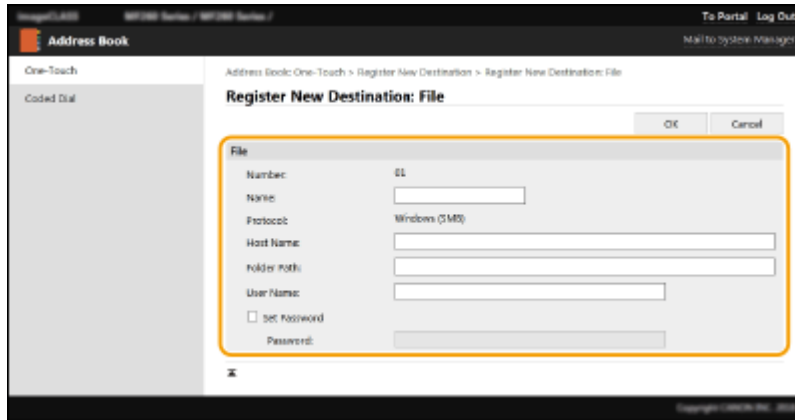

**[Name]**

Enter the name for the destination.

**[Host Name]**

Enter the computer name or IP address. You can include a path to the shared folder with the computer name or IP address (e.g. "\\swan\share" or "\\192.168.2.100\share").

**NOTE:**

**Using a DNS server**

- You can also enter the host name (or FQDN) instead of the computer name or IP address (e.g. for a shared folder: "\\swan.organization.company.com\share").

**[Folder Path]**

Enter the location of the folder to which the data will be sent.

Use "\" as a separator. Specify the level that follows the path specified in [Host Name].

**[User Name]**

Enter the user name set for the shared folder.

**[Set Password]**

To set a password for the shared folder, select the check box and enter a [Password].

**IMPORTANT**

**Ensure that the same display language is selected on both the computer and the Remote UI.**

- [Host Name] and [Folder Path] may not be displayed correctly or may not be referenceable.

**7** Click [OK].

LINKS

- ▶ Remote UI Screen(P. 336)

- ▶ **Saving/Loading Address Book from Remote UI(P. 351)**
- ▶ **Address Book List (Touch Panel Model)(P. 457)**

# Saving/Loading Address Book from Remote UI

2KUU-077

Address Book data in the machine can be saved on your computer (export). Data that is saved on your computer can also be registered in the machine (import). You can easily copy the destinations in the Address Book to multiple machines.\* To use these features, it is required that you have logged in to System Manager Mode.

\* Depending on the model, you cannot import the Address Book data that exported from the machine.

▶ **Exporting Address Book Data(P. 351)**

▶ **Loading Address Book Data(P. 352)**

## IMPORTANT

### Do not turn OFF the machine until the import or export process is complete

It may take a few minutes to complete the process. If the machine is turned OFF during the process, it may result in damage to data or the machine.

### Do not operate the machine during the import or export process

Before importing or exporting, check that no operation such as printing documents is currently proceeding.

## Exporting Address Book Data

- 1 Start the Remote UI and log in to System Manager Mode. ▶ Starting Remote UI(P. 335)**
- 2 Click [Settings/Registration] on the Portal page. ▶ Remote UI Screen(P. 336)**
- 3 Click [Import/Export] ▶ [Export].**
  - If the screen prompting you to enter the Address Book PIN is displayed, enter the [PIN] and click [OK]. ▶ **Restricting Use of the Address Book(P. 325)**
- 4 Click [Start Exporting].**
- 5 Follow the on-screen instructions to specify the location where the exported Address Book is saved.**
  - ▢ The Address Book will be saved.

## IMPORTANT

### Do not operate until the process is complete.

The screen remains the same during the export process. Do not operate the Remote UI until the message [The (file name) download has completed.] is displayed at the bottom of the screen.

## Loading Address Book Data

### IMPORTANT

The Address Book data currently registered is overwritten when you load the Address Book data.

**1 Start the Remote UI and log in to System Manager Mode.** ▶ **Starting Remote UI(P. 335)**

**2 Click [Settings/Registration] on the Portal page.** ▶ **Remote UI Screen(P. 336)**

**3 Click [Import/Export] ▶ [Import].**

- If the screen prompting you to enter the Address Book PIN is displayed, enter the [PIN] and click [OK]. ▶ **Restricting Use of the Address Book(P. 325)**

**4 Specify the Address Book file to be imported, and click [Start Importing].**

- To specify the file to be imported, click [Browse] and select the file.

**5 Click [OK].**

⇒ The specified Address Book data will be imported into the machine.

# Importing/Exporting Address Book Data with the Supplied Software

---

2KUU-0AH

You can export Address Book data saved on the machine to a computer using the Address Book Import/Export Tool contained on the provided CD-ROM/DVD-ROM. The data can be re-imported, providing a secure backup in case Address Book data becomes erased due to repairs or maintenance.

## NOTE

- Use the Address Book Import/Export Tool with the machine and computer connected via a USB cable.

- 1 Select <Menu> in the Home screen. ▶Home Screen(P. 111)**
- 2 Select <System Management Settings>.**
  - If the screen for entering a PIN appears, enter the correct PIN. ▶Setting the System Manager PIN(P. 293)
- 3 Select <Import/Export Address Book>.**
- 4 Place the provided CD-ROM/DVD-ROM in the PC.**
  - When the screen appears, click [Exit].
- 5 [Start] ▶ [Computer] ▶ Right-click the CD-ROM/DVD-ROM icon, and click [Open] in the pop-up menu.**
- 6 Open the [AddressBookTool] folder, and double-click [AddressBookTool.exe].**
- 7 Follow the on-screen instructions.**
  - To import Address Book data, click the [Import] tab.
  - To export Address Book data, click the [Export] tab.



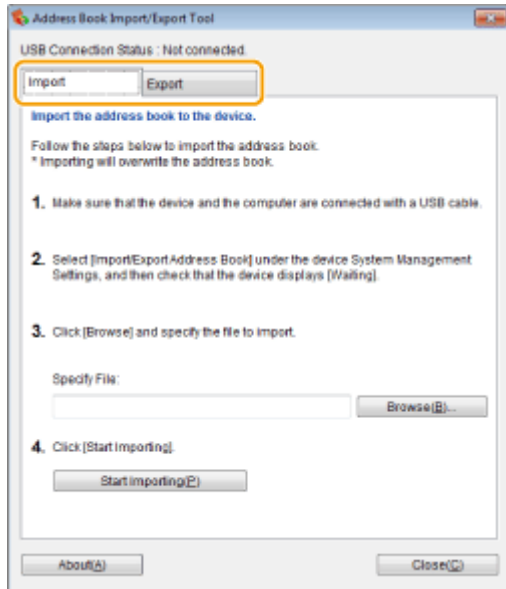

# Updating the Firmware

2KUU-078

For the firmware, select the method of update depending on the installation condition of the machine. There are two methods of update: the one is to access the latest firmware version on the Internet from the machine and perform the update if the version currently installed in the machine is not the latest, and the other is to access the latest firmware version on the Internet from a computer and perform the update from the computer if the version currently installed in the machine is not the latest. In an environment where connection to the Internet cannot be established via a wireless LAN, establish connection via a wired LAN or USB and perform the update from the computer.

Installation Condition of the Machine	How to Install the Update
Wireless LAN connection	▶ <b>Updating via the Internet(P. 355)</b>
Wired LAN connection	▶ <b>Updating via the Internet(P. 355)</b> ▶ <b>Updating from a Computer(P. 356)</b>
USB connection	▶ <b>Updating from a Computer(P. 356)</b>

## IMPORTANT

- If you are in an IPv6 environment, you cannot perform firmware update. Use USB to re-establish connection, and perform the update from the computer.

## NOTE

### Checking the firmware version

- You can check the firmware version from the operation panel of the machine. After completion of the firmware update operation, make sure that the update was performed correctly. ▶ **Checking the Firmware Version(P. 356)**

## Updating via the Internet

You can access the Canon server from the machine to update the firmware to the latest version.

### 1 Display the <Menu> screen. ▶ **Home Screen(P. 111)**

#### Touch Panel Model

Select <Menu> in the Home screen.

#### 5 Lines LCD Model

Press .

### 2 Select <System Management Settings>.

- If the screen for entering a PIN appears, enter the correct PIN. ▶ **Setting the System Manager PIN(P. 293)**

### 3 Select <Update Firmware>.

## 4 Select <Via Internet>.

⇒ A check for existence of the latest firmware is performed.

### NOTE:

- If the <This is the latest firmware version.> message is displayed, there is no need to update the firmware.

## 5 Check the message and select <Yes>.

## 6 When a license screen appears, press <Accept> ( ).

## 7 Select <OK>.

⇒ When the firmware update is complete, the machine restarts automatically.

### IMPORTANT:

- Do not turn OFF the machine while the restart is in progress.

## Updating from a Computer

When you have downloaded the latest firmware version from the Canon website, use "User Support Tool" utility software to update the firmware from a computer. For how to perform firmware update from a computer, see the "User Support Tool Operation Guide" included with the firmware.

### To Put the Machine into a Firmware Update Waiting State



<Menu> (  ) ▶ <System Management Settings> ▶ <Update Firmware> ▶ <Via PC> ▶ <Yes>

## Checking the Firmware Version

### 1 Display the <Menu> screen. ▶ Home Screen(P. 111)

#### Touch Panel Model

Select <Menu> in the Home screen.

#### 5 Lines LCD Model

Press .

### 2 Select <System Management Settings>.

- If the screen for entering a PIN appears, enter the correct PIN. ▶ Setting the System Manager PIN(P. 293)

**3** Select <Update Firmware>.

**4** Select <Version Information>.

⇒ The current firmware version is displayed.

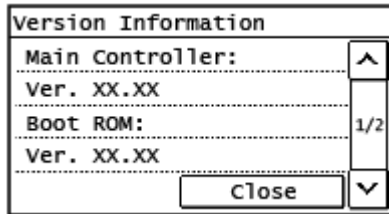

# Initializing Settings

2KUU-079



You can restore the following settings:

- ▶ **Initializing Eco Report Counter(P. 358)**
- ▶ **Initializing Menu(P. 358)**
- ▶ **Initializing Key and Certificate(P. 358)**
- ▶ **Initializing Address Book(P. 359)**
- ▶ **Initializing All Data/Settings(P. 359)**

## Initializing Eco Report Counter

You can restore the Eco Report Counter settings to the factory defaults.



<Menu> (  ) ▶ <System Management Settings> ▶ <Initialize Eco Report Counter> ▶ <Yes>

## Initializing Menu

You can restore the settings of the machine ( ▶ **Setting Menu List(P. 361)** ). Depending on the settings selected, you may need to restart the machine after initialization.



<Menu> (  ) ▶ <System Management Settings> ▶ <Initialize Menu> ▶ Select the item you want to initialize ▶ <Yes> ▶ Restart the machine if necessary

### NOTE

- You can restore the settings only for <Network Settings>.

<Menu> (  ) ▶ <Network Settings> ▶ <Initialize Network Settings> ▶ <Yes> ▶ Restart the machine

## Initializing Key and Certificate

You can restore the settings of the key and certificate and the CA certificate. Note that all the keys and certificates and CA certificates that you registered in the machine (except the preinstalled keys and CA certificates) will be deleted after initializing.

### NOTE

- After initializing, functions that require a key and certificate such as TLS encrypted communication are not available. To use these functions, configure the settings for the key and certificate and activate the functions again.



Log in to the Remote UI with Administrator privileges ( ▶ **Starting Remote UI(P. 335)** ) ▶ [Settings/Registration] ▶ [Initialize Setting Information] ▶ [Initialize Key and Certificate] ▶ [Initialize] ▶ [OK]

## Initializing Address Book

You can restore the settings of the Address Book. Note that all the information registered in the Address Book will be deleted after initializing.



<Menu> ▶ <System Management Settings> ▶ <Initialize Address Book> ▶ <Yes>

## Initializing All Data/Settings

This enables restoration of all data and machine settings, including logs, to the factory default values. This prevents sensitive data from being leaked when replacing or disposing of the machine. When the initialization process finishes, the machine automatically restarts.

### IMPORTANT

- Before initializing, make sure that there are no documents being processed or waiting to be processed. These documents will be deleted when initialization is performed.
- To use the machine after initializing it, you need to configure all settings from the beginning.



<Menu> (  ) ▶ <System Management Settings> ▶ <Initialize All Data/Settings> ▶ <Yes> ▶ <Yes>

### LINKS

- ▶ **Configuring the Key and Certificate for TLS(P. 308)**
- ▶ **Registering Destinations(P. 161)**
- ▶ **Registering Destinations from Remote UI(P. 347)**

# Setting Menu List

<b>Setting Menu List</b> .....	361
<Direct Connection> .....	362
<Network Settings> .....	363
<Output Rprt.>/<Output Reports> .....	374
<Preferences> .....	375
<Timer Settings> .....	381
<Common Settings> .....	385
<Copy Settings> .....	387
<Fax Settings> .....	389
<Scan Settings> .....	400
<Printer Settings> .....	405
<Adjustment/Maintenance> .....	415
<System Management Settings> .....	421

# Setting Menu List

---

2KUU-07A

You can customize the machine based on your environment and needs by configuring settings described in this chapter. To start configuration, display the <Menu> screen. This section describes what each item in the setting menu can configure.

## NOTE

- Refer to the PDF file included in the User's Guide that summarizes the setting menu. ▶ **Menu Route Map(P. 564)**

## TIPS

- You can print the setting menu in list form to check the current settings: ▶ **Printing Lists of Settings(P. 456)**



## <Direct Connection>

---

2KUU-07C

On the 5 Lines LCD Model, make a direct connection between a mobile device and the machine. ▶ **Connecting Directly (Access Point Mode)(P. 269)**  
Settings for Direct Connection can be specified from ▶ **<Direct Connection Settings>(P. 364)** .

## <Network Settings>

All the settings related to the network are listed with descriptions. Default settings are marked with a dagger (†).

- ▶<Select Wired/Wireless LAN>(P. 363)
- ▶<Wireless LAN Settings>(P. 363)
- ▶<Direct Connection Settings>(P. 364)
- ▶<Easy Connection via PC>(P. 366)
- ▶<TCP/IP Settings>(P. 366)
- ▶<SNMP Settings>(P. 370)
- ▶<Dedicated Port Settings>(P. 372)
- ▶<Waiting Time for Connection at Startup>(P. 372)
- ▶<Ethernet Driver Settings>(P. 372)
- ▶<IEEE 802.1X Settings>(P. 372)
- ▶<Initialize Network Settings>(P. 373)

### NOTE

#### Asterisks (\*)

- Settings marked with an asterisk (\*) may not be displayed depending on the model you are using or other setting items.

### <Select Wired/Wireless LAN>

When switching the machine from Wireless LAN to Wired LAN, you need to specify the setting. Conversely, when switching the machine from Wired LAN to Wireless LAN, you do not need to specify this setting (You can switch using the following <Wireless LAN Settings>). ▶<Selecting Wired LAN or Wireless LAN(P. 16)>

<Wired LAN> †  
<Wireless LAN>

### <Wireless LAN Settings>

Specify settings for connecting the machine to a wireless LAN. You can also view the current settings or specify the setting for saving power consumption.

#### <SSID Settings>

Select to configure a wireless connection by specifying information including an SSID or a network key by inputting manually from the operation panel.

#### <Select Access Point>

Wireless LAN routers that can access the machine are automatically located, so you can select from the list. You must manually enter a network key, such as a WEP key or a PSK. ▶<Setting Up Connection by Selecting a Wireless Router(P. 24)>

#### <Enter Manually>

Select to configure a wireless connection by manually entering an SSID. By using this method, you can specify authentication and encryption settings in detail. ▶<Setting Up Connection by Specifying Detailed Settings(P. 27)>

<Security Settings>

<None>  
 <WEP>  
     <Open System>  
         WEP Key 1 to 4  
     <Shared Key>  
         WEP Key 1 to 4  
 <WPA/WPA2-PSK>  
     <Auto>  
     <AES-CCMP>

### <WPS Push Button Mode>

Select to automatically configure a wireless connection by using the button on a WPS wireless router. **▶Setting Up Connection Using WPS Push Button Mode(P. 20)**

### <WPS PIN Code Mode>

Select to configure a wireless connection by entering a PIN code for a WPS wireless router. **▶Setting Up Connection Using WPS PIN Code Mode(P. 22)**

### <Power Save Mode>

Select whether or not the machine enters Power Save Mode based on signals emitted from the wireless router.

<Off>  
 <On> +



<Menu> (  ) ▶ <Network Settings> ▶ <Wireless LAN Settings> ▶ Read the displayed message ▶  
 <OK> ▶ <Power Save Mode> ▶ Select <Off> or <On>

### <Wireless LAN Information>

Select to view the current wireless LAN settings. **▶Viewing Network Settings(P. 38)**

<MAC Address>  
 <Wireless LAN Status>  
 <Latest Error Information>  
 <Channel>  
 <SSID Settings>  
 <Security Settings>  
 <Power Save Mode>

## <Direct Connection Settings>

Configure settings for Direct Connection. After configuring settings, you can connect to the machine directly and wirelessly from a mobile device even without an access point or wireless LAN router.

### <Use Direct Connection>

Select whether to use Direct Connection. **▶Connecting Directly (Access Point Mode)(P. 269)**

<Off> +  
 <On>

### <Time Until Direct Connection Termination>

Specify the time to automatically disconnect after Direct Connection is established.

0 (Do not terminate session automatically)  
1 to 10 + to 60 (min.)



<Menu> (  ) ▶ <Network Settings> ▶ <Direct Connection Settings> ▶ <Time Until Direct Connection Termination> ▶ Enter the time ▶ <Apply> (  )

### <Access Point Mode Settings>

Configure the SSID/network key arbitrarily. If you want to connect multiple mobile devices to the machine at the same time, you need to configure both SSID and network key arbitrarily.

**<Use Custom SSID>**  
<Off> +  
<On>  
<SSID (1-20 Characters)>

**<Use Custom Network Key>**  
<Off> +  
<On>  
<Network Key (10 Char.)>





<Menu> (  ) ▶ <Network Settings> ▶ <Direct Connection Settings> ▶ <Access Point Mode Settings> ▶ <Use Custom SSID> or <Use Custom Network Key> ▶ <On> ▶ Enter the SSID/network key ▶ <Apply>

### <IP Address Settings for Direct Conn.>

Specify an IP address for using Direct Connection.



<Menu> (  ) ▶ <Network Settings> ▶ <Direct Connection Settings> ▶ <IP Address Settings for Direct Conn.> ▶ Enter the IP address ▶ <Apply> (  )

## NOTE

- Do not use the same number as the IP addresses for direct connection and for the machine's wired LAN/wireless LAN connection. If you set the same number, then a direct connection cannot be initiated.

## <Easy Connection via PC>

Start Easy Connection via PC (cableless setup mode). This allows you to use Canon Laser NW Device Setup Utility on your PC to configure network settings.



<Menu> (  ) ▶ <Network Settings> ▶ <Easy Connection via PC> ▶ Start connecting

## NOTE

- "Canon Laser NW Device Setup Utility" is available on the Canon website (<http://www.canon.com/>).

## <TCP/IP Settings>

Specify settings for using the machine in a TCP/IP network, such as IP address settings.

### <IPv4 Settings>

Specify settings for using the machine in an IPv4 network.

### <IP Address Settings>

Configure the IP address, which is used for identifying devices, such as computers and printers, on a TCP/IP network. ▶ **Setting IPv4 Address(P. 32)**

#### <Auto Acquire> †

<Select Protocol>

<Off>

<DHCP> †

<BOOTP>

<RARP>

<Auto IP>

<Off>

<On> †

#### <Manually Acquire>

<IP Address>: 0.0.0.0

<Subnet Mask>: 0.0.0.0

<Gateway Address>: 0.0.0.0

#### <Check Settings>

<Auto Acquire>\*

<IP Address>

<Subnet Mask>



<Gateway Address>

### <PING Command>

Select to check that the machine is connected to a computer over a network. ▶ **Testing the Network Connection(P. 33)**

**<DNS Settings>**

Specify settings for Domain Name System (DNS), which provides a host name for IP address resolutions.  **Configuring DNS(P. 57)**

<p><b>&lt;DNS Server Settings&gt;</b>          &lt;Primary DNS Server&gt;: 0.0.0.0          &lt;Secondary DNS Server&gt;: 0.0.0.0</p> <p><b>&lt;DNS Host Name/Domain Name Settings&gt;</b>          &lt;Host Name&gt;          &lt;Domain Name&gt;</p> <p><b>&lt;DNS Dynamic Update Settings&gt;</b>          &lt;Off&gt;           &lt;On&gt;          &lt;DNS Dyn. Updt. Intrvl.&gt;          0 to 24  to 48 (hr.)</p>
--





**<mDNS Settings>**

Specify settings for using DNS functions without DNS servers.

<p>&lt;Off&gt;</p> <p>&lt;On&gt;           &lt;mDNS Name&gt;</p>
--

**<DHCP Option Settings>**

If DHCP is enabled, use these settings to select whether to use the DHCP optional functions to acquire the host name and to use the dynamic update function.  **Configuring DNS(P. 57)**

<p><b>&lt;Acquire Host Name&gt;</b>          &lt;Off&gt;          &lt;On&gt; </p> <p><b>&lt;DNS Dynamic Update&gt;</b>          &lt;Off&gt;           &lt;On&gt;</p> <p><b>&lt;Acquire SMTP Server Address&gt; *</b>          &lt;Off&gt;           &lt;On&gt;</p> <p><b>&lt;Acquire POP Server Address&gt; *</b>          &lt;Off&gt;           &lt;On&gt;</p>
---

**<IPv6 Settings>**

Specify settings for using the machine in an IPv6 network.  **Setting IPv6 Addresses(P. 35)**

**<Use IPv6>**

Enable or disable IPv6 in the machine. You can also view the current settings.

<Off> †

<On>

<Check Settings>  
 <Link-Local Address>  
 <Prefix Length>

### <Stateless Address Settings>

Enable or disable stateless addresses.

<Off>

<On> †

<Check Settings>  
 <Stateless Address>  
 <Prefix Length>

### <Use DHCPv6>

Enable or disable the stateful address that is acquired via DHCPv6.

<Off> †

<On>

<Check Settings>  
 <Stateful Address>  
 <Prefix Length>

### <DNS Settings>

Specify settings for Domain Name System (DNS), which provides a host name for IP address resolutions.  **Configuring DNS(P. 57)**

<DNS Host Name/Domain Name Settings>  
 <Use IPv4 Host/Domain>  
 <Off>  
 <Host Name>  
 <Domain Name>  
 <On> †

<DNS Dynamic Update Settings>  
 <Off> †  
 <On>  
 <Register Manual Address>  
 <Off> †  
 <On>  
 <Register Stateful Address>  
 <Off> †  
 <On>  
 <Register Stateless Address>  
 <Off> †

<On>  
 <DNS Dynamic Update Interval>  
 0 to 24 † to 48 (hr.)

### <mDNS Settings>

Specify settings for using DNS functions without DNS servers.

<Off>  
 <On> †  
 <Use IPv4 Name for mDNS>  
 <Off>  
 <mDNS Name>  
 <On> †

### <LPD Print Settings>

Enable or disable LPD, a printing protocol that can be used on any hardware platform or operating system. ▶ **Configuring Printing Protocols and WSD Functions(P. 42)**

<Off>  
 <On> †

### <RAW Print Settings>

Enable or disable RAW, a Windows specific printing protocol. ▶ **Configuring Printing Protocols and WSD Functions(P. 42)**

<Off>  
 <On> †

### <WSD Settings>

Enable or disable automatic browsing and acquiring information for the printer by using the WSD protocol. ▶ **Configuring Printing Protocols and WSD Functions(P. 42)**

<WSD Print Settings>  
 <Use WSD Print>  
 <Off>  
 <On> †  
 <Use WSD Browsing>  
 <Off>  
 <On> †  
 <WSD Scan Settings>  
 <Use WSD Scan>  
 <Off> †  
 <On>  
 <Use Computer Scan>  
 <Off> †  
 <On>  
 <Use Multicast Discovery>  
 <Off>



<On> †

### <Use HTTP>

Enable or disable HTTP, which is required for communications with a computer, such as when using the Remote UI, WSD printing, or printing with Google Cloud Print. ▶ **Disabling HTTP Communication(P. 332)**

<Off>  
<On> †

### <Port Number Settings>

Change port numbers for protocols according to the network environment. ▶ **Changing Port Numbers(P. 305)**

<LPD>  
1 to 515 † to 65535

<RAW>  
1 to 9100 † to 65535

<WSD Multicast Discovery>  
1 to 3702 † to 65535

<HTTP>  
1 to 80 † to 65535

<POP3> \*  
1 to 110 † to 65535

<SMTP> \*  
1 to 25 † to 65535

<SNMP>  
1 to 161 † to 65535

### <MTU Size>

Select the maximum size of packets the machine receives. ▶ **Changing the Maximum Transmission Unit(P. 55)**

<1300>  
<1400>  
<1500> †

## <SNMP Settings>

Specify the settings for monitoring and controlling the machine from a computer running SNMP-compatible software. ▶ **Monitoring and Controlling the Machine with SNMP(P. 63)**

### <SNMPv1 Settings>

Enable or disable SNMPv1. When enabling SNMPv1, specify a community name and access privileges to Management Information Base (MIB) objects.

<Off>

<On> †  
 <Community Name 1 Settings>  
     <Off>  
     <On> †  
         <Community Name>  
         <MIB Access Permission>  
 <Community Name 2 Settings>  
     <Off> †  
     <On>  
         <Community Name>  
         <MIB Access Permission>  
 <Dedicated Community Settings>  
     <Off>  
     <On> †



<Menu> (  ) ▶ <Network Settings> ▶ <SNMP Settings> ▶ <SNMPv1 Settings> ▶ <SNMPv1 Settings> ▶ Select <Off> or <On> ▶ Specify settings if <On> is selected

**<SNMPv3 Settings>**

Enable or disable SNMPv3. Use the Remote UI to specify detailed settings that are applied when SNMPv3 is enabled.

<Off> †  
 <On>





<Menu> (  ) ▶ <Network Settings> ▶ <SNMP Settings> ▶ <SNMPv3 Settings> ▶ Select <Off> or <On>

**<Acquire Printer Mngt. Info. from Host>**

Enable or disable the monitoring of printer management information from a networked computer running SNMP-compatible software.

<Off> †  
 <On>



<Menu> (  ) ▶ <Network Settings> ▶ <SNMP Settings> ▶ <Acquire Printer Mngt. Info. from Host> ▶ Select <Off> or <On>

## <Dedicated Port Settings>

Enable or disable the dedicated port. The dedicated port is used when printing from the computer and when browsing or specifying the machine settings over the network.

<Off>  
<On> +



<Menu> (  ) ▶ <Network Settings> ▶ <Dedicated Port Settings> ▶ Select <Off> or <On>

## <Waiting Time for Connection at Startup>

Specify a wait time for connecting to a network. Select the setting depending on the network environment. **▶Setting a Wait Time for Connecting to a Network(P. 56)**

0 + to 300 (sec.)

## <Ethernet Driver Settings>

Select the communication mode of Ethernet (half-duplex/full-duplex) and the Ethernet type (10BASE-T/100BASE-TX). You can also view the MAC address of the machine.

### <Auto Detect>

Select whether to automatically detect or manually select the communication mode and the Ethernet type. **▶Configuring Ethernet Settings(P. 53)**

<Off>  
<Communication Mode>  
<Half Duplex> +  
<Full Duplex>  
<Ethernet Type>  
<10BASE-T> +  
<100BASE-TX>  
  
<On> +

### <MAC Address>

Check the MAC address of the machine, which is a number unique to each communication device. **▶Viewing the MAC Address for Wired LAN(P. 38)**

## <IEEE 802.1X Settings>

Enable or disable IEEE 802.1X authentication. **▶Configuring IEEE 802.1X Authentication Settings(P. 318)**

<Off> +  
<On>

## <Initialize Network Settings>

Select to return the Network Settings to the factory defaults. ▶<Initialize Menu>(P. 428)

## <Output Rprt.>/<Output Reports>

---

2KUU-07F

You can print out and check the settings of machine setting options and other details as reports or lists.  **Printing Reports and Lists(P. 455)**

## <Preferences>

2KUU-07H

All the settings related to viewing of the display are listed with descriptions. Default settings are marked with a dagger (†).

▶<Volume Settings>(P. 375)

▶<Display Settings>(P. 377)

### NOTE

#### Asterisks (\*)

- Settings marked with "\*"1" may not be displayed depending on the model you are using, or other setting items.
- Settings marked with "\*"2" may be unavailable or vary or have different defaults depending on your country or region.

### <Volume Settings> \*1

Adjust volume at which the machine beeps when a key is pressed on the operation panel or when a paper jam occurs.

▶<Setting Sounds>(P. 155)

#### <Fax Tone>

Select whether to make a dial tone while a fax is being sent. You can also adjust the volume.

5 levels

#### <Ring Tone>

Select whether the machine beeps when a fax is received. You can also adjust the volume.

6 levels

#### <TX Done Tone>

Select whether the machine beeps when a fax is sent. You can also adjust the volume.

6 levels

#### <When Error>

<Off> †

<On>

#### <RX Done Tone>

Select whether the machine beeps when a fax is received. You can also adjust the volume.

6 levels

#### <When Error>

<Off> †

<On>

### <Scanning Done Tone>

---

Select whether the machine beeps when scanning fax documents is complete. You can also adjust the volume.

#### 6 levels

##### <When Error>

<Off> †

<On>

### <Entry Tone>

---

Select whether the machine beeps when a key is pressed on the operation panel.

<Off>

<On> †

### <Invalid Entry Tone>

---

Select whether the machine beeps when an invalid settings value is entered, such as when a user is trying to enter a number unavailable for a setting.

<Off> †

<On>

### <Warning Tone>

---

Select whether the machine beeps when problem such as a paper jam or an operation mistake occurs.

<Off>

<On> †

### <Job Done Tone>

---

Select whether the machine beeps when copying or scanning is complete.

<Off>

<On> †

### <Energy Saver Alert>

---

Select whether the machine beeps when the machine enters or wakes from sleep mode.

<Off> †

<On>

### <Original in Feeder Detection Tone>

---

Select whether the machine beeps when an original is loaded in the feeder.

<Off>

<On> †

## <Display Settings>

### <Default Screen after Startup/Restoration> \*1

By default, the Home screen is displayed immediately after the machine is turned ON or when the Auto Reset function is performed. Specify the setting to change the default screen and display the main screen of a different function.

<Home> +  
 <Copy>  
 <Fax>  
 <Scan>



<Menu> ► <Preferences> ► <Display Settings> ► <Default Screen after Startup/Restoration> ►  
 Select a function to display the desired screen

### <Home Screen Button Display Settings> \*1



Change the order in which Home Screen buttons are displayed.  **Customizing the Home Screen(P. 152)**

### <Contrast>

Adjust the contrast (the difference between the light and dark parts) of the display to suit the installation location of the machine.

5 Levels





<Menu> (  ) ► <Preferences> ► <Display Settings> ► <Contrast> ► Adjust the contrast ► <Apply>  
 (  )

### <Invert Screen Colors>

Select <On> to invert the display colors. Select <On> if the display is hard to view even after the brightness was adjusted in <Contrast>.

<Off> +  
 <On>



<Menu> (  ) ► <Preferences> ► <Display Settings> ► <Invert Screen Colors> ► Select <Off> or <On>



**<Millimeter/Inch Entry Switch> \*2**

Select the unit of measurement.

<Millimeter>  
<Inch> †



<Menu> (  ) ▶ <Preferences> ▶ <Display Settings> ▶ <Millimeter/Inch Entry Switch> ▶ Select <Millimeter> or <Inch>

**<Gram/Pound Switch> \*2**

Select the unit of measurement for the basis weight. This setting is available when <Select Country/Region> is set to <United States (US)>.

<Gram>  
<Pound> †



<Menu> (  ) ▶ <Preferences> ▶ <Display Settings> ▶ <Gram/Pound Switch> ▶ Select <Gram> or <Pound>

**<Notify to Check Paper Settings>**

Specify whether to display a message prompting you to check paper settings when loading paper into the drawer or multi-purpose tray.

<Off>  
<On> †





<Menu> (  ) ▶ <Preferences> ▶ <Display Settings> ▶ <Notify to Check Paper Settings> ▶ Select <Off> or <On>

**<Notify to Clean Original Scanning Area>**

Specify whether to display a message when stains are detected in the original scanning area.

<Off>  
<On> †





<Menu> (  ) ▶ <Preferences> ▶ <Display Settings> ▶ <Notify to Clean Original Scanning Area> ▶  
Select <Off> or <On>

### <Message Display Time>

Specify the interval in seconds at which two different messages are alternately displayed.

1 to 2 <sup>†</sup> to 5 (sec.)





<Menu> (  ) ▶ <Preferences> ▶ <Display Settings> ▶ <Message Display Time> ▶ Enter a number for the interval ▶ <Apply> (  )

### <Scrolling Speed>

Adjust the scrolling speed of the screen by selecting from 3 levels.

<Slow>  
<Standard> <sup>†</sup>  
<Fast>





<Menu> (  ) ▶ <Preferences> ▶ <Display Settings> ▶ <Scrolling Speed> ▶ Select the speed

### <Cursor Movement Type>

Configure how the cursor moves after a character is entered on the screen. Select <Auto> to automatically move the cursor to the right of the entered character. Select <Manual> to manually move the cursor to the right of the entered character.

<Auto> <sup>†</sup>  
<Manual>



<Menu> (  ) ▶ <Preferences> ▶ <Display Settings> ▶ <Cursor Movement Type> ▶ Select <Auto> or <Manual>

### <Language> \*2

Select the display language used for the display, reports, and lists.

<Chinese (Simplified)>  
<Chinese (Traditional)>  
<English> <sup>†</sup>

<French>  
 <German>  
 <Italian>  
 <Japanese>  
 <Korean>  
 <Portuguese>  
 <Spanish>



<Menu> (  ) ▶ <Preferences> ▶ <Display Settings> ▶ <Language> ▶ Select a language

### <Remote UI Language> \*2

Select the display language used for the Remote UI screens.

<Chinese (Simplified)>  
 <Chinese (Traditional)>  
 <English> †  
 <French>  
 <German>  
 <Italian>  
 <Japanese>  
 <Korean>  
 <Portuguese>  
 <Spanish>



<Menu> (  ) ▶ <Preferences> ▶ <Display Settings> ▶ <Remote UI Language> ▶ Select a language

## <Timer Settings>

All the settings related to the timer are listed with descriptions. Default settings are marked with a dagger (†).

- ▶<Quiet Mode Time>(P. 381)
- ▶<Date/Time Settings>(P. 381)
- ▶<Auto Sleep Time>(P. 383)
- ▶<Auto Reset Time>(P. 383)
- ▶<Function After Auto Reset>(P. 383)
- ▶<Auto Offline Time>(P. 384)

### NOTE

#### Asterisks (\*)

- Settings marked with an asterisk (\*) may have different defaults depending on your country or region.

### <Quiet Mode Time>

You can reduce the operation sound of the machine when you want it to run more quietly (quiet mode). Set a time for the machine to enter quiet mode automatically. You can also set the machine to always run in quiet mode. ▶<Entering Quiet Mode>(P. 157)

<Start Time>  
 <Off> †  
 <On>  
 Start time setting to enter quiet mode

<End Time>  
 <Off> †  
 <On>  
 Stop time setting to exit quiet mode

### <Date/Time Settings>

Specify date and time settings, including the date format and the 12- or 24-hour clock display setting.

#### <Date Format> \*

Select the date format (order of year, month, and day).

<YYYY MM/DD>  
 <MM/DD/YYYY> †  
 <DD/MM YYYY>



<Menu> ( ) ▶ <Timer Settings> ▶ <Date/Time Settings> ▶ <Date Format> ▶ Select the date format

**<Time Format>**

Select the 12- or 24-hour clock display setting.

<12 Hour (AM/PM)> +  
<24 Hour>



<Menu> (  ) ▶ <Timer Settings> ▶ <Date/Time Settings> ▶ <Time Format> ▶ Select the display setting

**<Current Date/Time Settings>**

Set the current date and time.  **Setting the Date/Time(P. 11)**

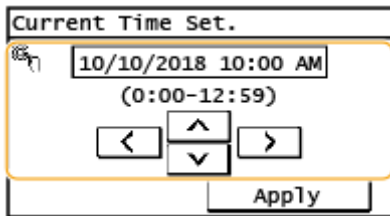
**IMPORTANT**

- Set <Time Zone> before setting the current date and time. If the <Time Zone> setting is changed, the current date and time are also changed accordingly.

**NOTE**

- The current date and time cannot be changed for 1 hour after daylight saving time is in effect.

**<Time Zone> \***

Select the time zone. The default setting may vary depending on the setting selected at initial power-on. If the time zone setting is changed, the values set in <Current Date/Time Settings> are also changed accordingly.  **Setting the Date/Time(P. 11)**

<(UTC-12:00) International Date Line West> to <(UTC+14:00) Kiritimati Island>

**NOTE****UTC**

- Coordinated Universal Time (UTC) is the primary time standard by which the world regulates clocks and time. The correct UTC time zone setting is required for Internet communications.

**<Daylight Saving Time Settings> \***

Enable or disable daylight saving time. If daylight saving time is enabled, specify the dates from which and to which daylight saving time is in effect.  **Setting the Date/Time(P. 11)**

<Off> +

<On>

Start: Month, Week, Day

End: Month, Week, Day

### <Auto Sleep Time>

If the machine has not been operated or has had no data to process for a specified period of time, the machine enters sleep mode to save energy consumption (Auto Sleep). Specify the period of time after which auto sleep is performed. Auto Sleep is not performed when the setting menu is displayed. We recommend using the factory default settings to save the most power. **▶ Entering Sleep Mode(P. 159)**

1 <sup>†</sup> to 30 (min.)



### <Auto Reset Time>

If a key is not pressed for a specified period of time, the screen and the settings are initialized to display the default screen (Auto Reset). Specify the interval at which the Auto Reset is performed. The Auto Reset is not performed in the following cases:

- The setting menu is displayed.
- The machine is processing data, such as when printing documents.
- An error message is displayed and the Alarm indicator is blinking (However, Auto Reset is performed when the error does not prevent the user from continuing to use a function.)

0 (Auto Reset is disabled.)  
1 to 2 <sup>†</sup> to 9 (min.)



<Menu> (  ) ▶ <Timer Settings> ▶ <Auto Reset Time> ▶ Specify the Auto Reset time ▶ <Apply>  
(  )

### <Function After Auto Reset>

Select whether to return the display to the default screen after the Auto Reset is performed. On the touch panel model, if <Default Function> is selected, the main screen of the function selected in <Default Screen after Startup/Restoration> is displayed ( **▶ Default Screen after Startup/Restoration>(P. 377)** ). On the 5 Lines LCD model, if <Default Function> is selected, the display returns to the main screen for copy mode. If <Selected Function> is selected, the display returns to the main screen of the function that was selected.

<Default Function> <sup>†</sup>  
<Selected Function>



<Menu> (  ) ▶ <Timer Settings> ▶ <Function After Auto Reset> ▶ Select <Default Function> or <Selected Function>

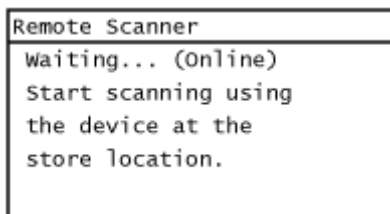

## <Auto Offline Time>

If a key has not been pressed for a specified period of time after the screen below is displayed (the machine is set online for scanning), the machine automatically becomes offline. Specify the time period at which the machine becomes offline. You can also set the machine to remain online.



0 (Auto Offline is disabled.)  
1 to 5 + to 60 (min.)



<Menu> (  ) ▶ <Timer Settings> ▶ <Auto Offline Time> ▶ Set the time period ▶ <Apply> (  )

## <Common Settings>

All the settings related to the paper feed method are listed with descriptions. Default settings are marked with a dagger ( † ).

### <Switch Paper Feed Method>

Specify this setting when you print a document on paper with logos. In general use, to print on paper with logos, you need to change how the paper loaded in the paper source is facing depending on whether you are performing 1- or 2-sided printing. However, if you change the setting to <Print Side Priority>, you can just load the paper with the logo side facing down for 1-sided printing in the same way as for 2-sided printing. **Loading Preprinted Paper(P. 143)** .

#### <Multi-Purpose Tray>

<Speed Priority> †

<Print Side Priority>

#### <Drawer 1>

<Speed Priority> †

<Print Side Priority>



<Menu> (  ) ▶ <Common Settings> ▶ <Switch Paper Feed Method> ▶ Select the paper source  
▶ Select <Speed Priority> or <Print Side Priority>

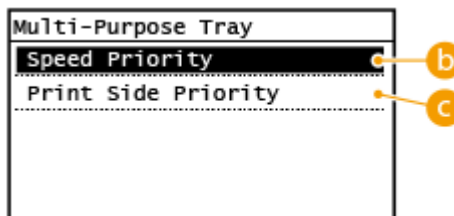
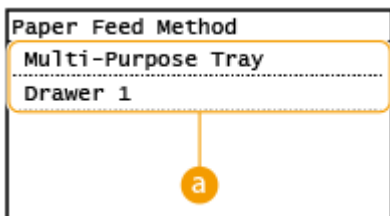

#### **a** Paper Sources

Select the paper source that you want to change the setting for.

#### **b** <Speed Priority>

When using paper that has been preprinted with a logo, you need to change how it is facing when you perform 1-sided and 2-sided printing.

#### **NOTE:**

We recommend selecting <Speed Priority> if you do not need to consider which side to print on.

#### **c** <Print Side Priority>

To print on a specific side of paper, you do not need to flip over paper in the paper source whether 1- or 2-sided printing is selected.

#### **NOTE:**



## Setting Menu List

- If <Print Side Priority> is set for a paper source that is loaded with paper you cannot use for 2-sided printing ( ▶ **Available Paper(P. 538)** ), <Speed Priority> is applied to the paper source instead. In this case, you need to load the paper in the same way as when <Speed Priority> is selected ( ▶ **Loading Preprinted Paper(P. 143)** ).
- 1-sided printing speed may be slower when <Print Side Priority> is selected.

## <Copy Settings>

All the settings related to the copy are listed with descriptions. Default settings are marked with a dagger ( † ).

- ▶<Change Default Settings>(P. 387)
- ▶<Correct Density>(P. 388)
- ▶<Initialize Default Settings>(P. 388)

### NOTE

#### Asterisks (\*)

- Settings marked with an asterisk (\*) may not be displayed depending on the model you are using.

## <Change Default Settings>

You can change the default settings about copy. The selected settings are used as the default settings of the copy function. ▶<Changing the Default Settings for Functions>(P. 154)

#### <Number of Copies>

1 † to 999

#### <Density>

9 Levels

<Auto Density>

#### <Original Type>

<Text>

<Text/Photo (High Speed)> †

<Text/Photo>

<Photo>

#### <2-Sided>

<Off> †

<1->2-Sided>

<2->2-Sided>\*

<2->1-Sided>\*

<Original/Finishing Type>

#### <Copy Ratio>

<Custom Ratio>

<100% (Direct)> †

<400% (Max)>

<200%>

<129% STMT->LTR>

<78% LGL->LTR>

<64% LTR->STMT>

<50%>

<25% (Min)>

**<N on 1>**  
 <Off> †  
 <2 on 1>  
 <4 on 1>  
 <ID Card Copy>  
 <Select Layout>

**<Passport Copy>**  
 <Off> †  
 <2 on 1 (2-Sided)>  
 <4 on 1 (2-Sided)>  
 <2 on 1>  
 <4 on 1>



**<Collate>**  
 <Off> †  
 <On>

**<Sharpness>**  
 7 Levels

## <Correct Density>



Specify the initial copy density. You can also change the copy density temporarily. **Basic Copy Operations(P. 173)**

9 Levels

 <Menu> (  ) ▶ <Copy Settings> ▶ <Correct Density> ▶ Adjust the density ▶ <Apply> (  )

## <Initialize Default Settings>

Select to restore the default copy settings.

 <Menu> (  ) ▶ <Copy Settings> ▶ <Initialize Default Settings> ▶ <Yes>

## <Fax Settings>

All the settings about the fax are listed with short descriptions. Default settings are marked with a dagger (†).

- ▶<Basic Settings>(P. 389)
- ▶<TX Function Settings>(P. 391)
- ▶<RX Function Settings>(P. 394)
- ▶<RX Print Settings>(P. 396)
- ▶<Forwarding Settings>(P. 398)
- ▶<Fax Setup Guide>(P. 399)

### NOTE

#### Asterisks (\*)

- Settings marked with "\*1" may not be displayed depending on the model you are using.
- Settings marked with "\*2" may be unavailable or vary or have different defaults depending on your country or region.

## <Basic Settings>

Specify the basic settings for using the machine as a fax device.

### <Register Unit Telephone Number>

Register the fax number for the machine. ▶<Registering the Fax Number and Unit Name>(P. 72)

### <Select Line Type>

Select the telephone line type used for fax transmission. ▶<Connecting the Telephone Line>(P. 74)

<Pulse>  
<Tone> †

### <Public Line Connection>

When the fax receive mode is <Fax/Tel (Auto Switch)>, an external telephone may not ring or a call may not be dialable. In this instance, specify <Adapter 1> or <Adapter 2>.

<Direct> †  
<Adapter 1>  
<Adapter 2>



<Menu> ▶ <Fax Settings> ▶ <Basic Settings> ▶ <Public Line Connection> ▶ Select connection type

### <Off-Hook Alarm>

Select whether the machine makes an alert sound when the handset of a telephone connected to the machine is not properly set on the cradle. You can also adjust the volume of the alert sound.

6 Levels



<Menu> ▶ <Fax Settings> ▶ <Basic Settings> ▶ <Off-Hook Alarm> ▶ Select the volume of the alert sound ▶ <Apply>

### <Communication Management Settings>

Adjust the communication start speed in descending order from "33600 bps." This adjustment should be made when it takes a long time to start sending or receiving a fax due to a poor telephone line connection.

#### <TX Start Speed>

<33600 bps> †

<14400 bps>

<9600 bps>

<7200 bps>

<4800 bps>

<2400 bps>

#### <RX Start Speed>

<33600 bps> †

<14400 bps>

<9600 bps>

<7200 bps>

<4800 bps>

<2400 bps>



<Menu> ▶ <Fax Settings> ▶ <Basic Settings> ▶ <Communication Management Settings> ▶ Select <TX Start Speed> or <RX Start Speed> ▶ Select a communication start speed

### <Auto Adjust VoIP Comm. Speed>

Specify whether to reduce communication errors on a poor-quality line that experiences much packet loss.

<Off> †

<On>



<Menu> ▶ <Fax Settings> ▶ <Basic Settings> ▶ <Auto Adjust VoIP Comm. Speed> ▶ Select <Off> or <On>

## NOTE

- Setting <Auto Adjust VoIP Comm. Speed> to <On> causes the initial transmitting speed when sending or receiving a fax to be slower.

## <TX Function Settings>

Specify settings for sending faxes.

### <Change Default Settings>

You can change the default settings used for sending faxes. The selected settings are used as the default settings when scanning originals. **▶<Changing the Default Settings for Functions>(P. 154)**

#### <Resolution>

- <200 x 100 dpi (Normal)> †
- <200 x 200 dpi (Fine)>
- <200 x 200 dpi (Photo)>
- <200 x 400 dpi (Superfine)>

#### <Density>

9 Levels

#### <2-Sided Original> \*1

- <Off> †
- <Book Type>
- <Calendar Type>

#### <Sharpness>

7 Levels

### <Register Unit Name>

Register the name of a company or person. **▶<Registering the Fax Number and Unit Name>(P. 72)**

The registered name is sent as sender information to the destination. **▶<TX Terminal ID>(P. 393)**



<Menu> ▶ <Fax Settings> ▶ <TX Function Settings> ▶ <Register Unit Name> ▶ Enter the unit name  
▶ <Apply>

### <ECM TX>

Enable or disable error correction mode (ECM). ECM checks for fax data errors and corrects them. To reduce errors on received faxes, see **▶<ECM RX>(P. 394)** .

- <Off>
- <On> †

## NOTE

- ECM must be enabled on both the machine and the other fax device because error checks are performed on both the sending and receiving devices.
- Even when ECM is enabled, errors may occur due to telephone line conditions.

- It may take a longer time than usual to process data when ECM is enabled because the error checks and corrections are performed while the data is transmitted.



<Menu> ▶ <Fax Settings> ▶ <TX Function Settings> ▶ <ECM TX> ▶ Select <Off> or <On>

### <Set Pause Time>

For example, when you make calls by dialing "0 - (pause) - (telephone number)", 0 is dialed first and then a few seconds later, the telephone number. When sending faxes overseas, you need to specify destinations by dialing "(international access code) - (country code) - (area code) - (fax number)" but consecutive numbers that are input without pauses may not be recognized correctly. In this case, try adding a pause after the international access code or the fax number. If the code or the number is still not recognized correctly, change the duration of the pause. For instructions on how to enter a pause, see step 4 on **Basic Operations for Sending Faxes(P. 195)** .

1 to 2 <sup>†</sup> to 15 (sec.)



<Menu> ▶ <Fax Settings> ▶ <TX Function Settings> ▶ <Set Pause Time> ▶ Specify the duration of pause ▶ <Apply>

### <Auto Redial>

Specify settings for Auto Redial, a function that automatically redials the fax number after several minutes if the first attempt fails because the line is busy. You can specify how many times the machine redials and the interval between redials.

<Off>

<On> <sup>†</sup>

<Number of Times to Redial>

1 to 2 <sup>†</sup> to 10 (times)

<Redial Interval>

2 <sup>†</sup> to 99 (min.)

<Redial When Error Occurs>

<Off>

<On> <sup>†</sup>



<Menu> ▶ <Fax Settings> ▶ <TX Function Settings> ▶ <Auto Redial> ▶ <On> ▶ Specify the settings ▶ <Apply>

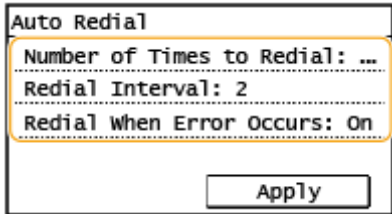

**<Number of Times to Redial>**

Specifies how many times the machine redials. Enter a number, and select <Apply>.

**<Redial Interval>**

Specifies the interval between redials. Enter a number, and select <Apply>.

**<Redial When Error Occurs>**

When set to <On>, specifies to redial when a transmission error occurs.

**<TX Terminal ID>**

Specify settings for adding the sender information, including the fax number and the name of the machine, to the fax header. The recipient can check who sent the fax by looking at the added information.

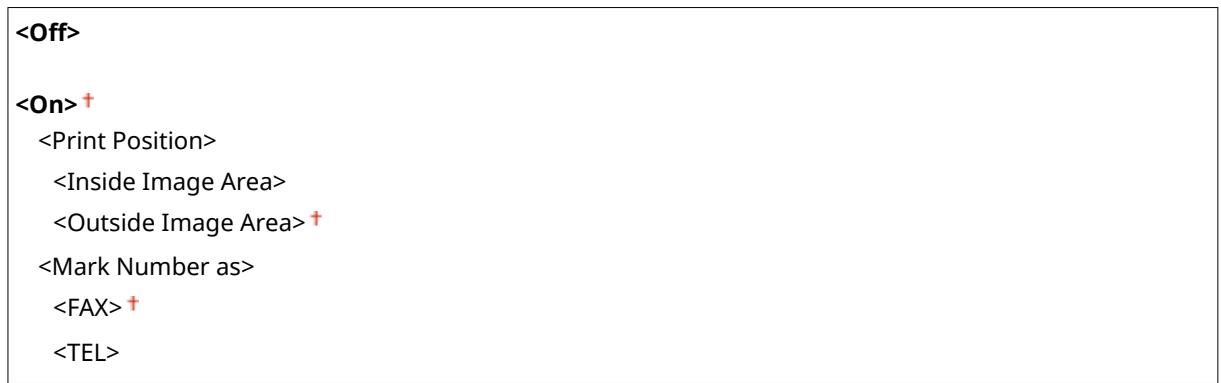

 <Menu> ▶ <Fax Settings> ▶ <TX Function Settings> ▶ <TX Terminal ID> ▶ <On> ▶ Specify the settings ▶ <Apply>

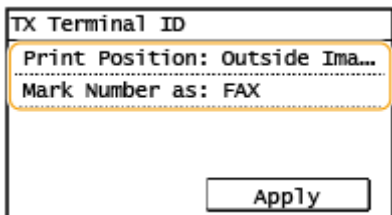

**<Print Position>**

Specifies the position to print the terminal ID information in the sent fax. Select <Inside Image Area> to print the information inside the image area, or <Outside Image Area> to print the information outside the image area.

**<Mark Number as>**

Adds the "FAX" or "TEL" mark in front of the fax number registered for the machine (  **Registering the Fax Number and Unit Name(P. 72)** ). Select <TEL> to indicate that the notified number is a telephone number.

**<Check Dial Tone Before Sending> \*2**

Select whether to check the dial tone before a fax number is dialed.



<Off> +  
<On>



<Menu> ▶ <Fax Settings> ▶ <TX Function Settings> ▶ <Check Dial Tone Before Sending> ▶ Select <Off> or <On>

### <Allow Fax Driver TX>

Enable or disable PC faxing (sending faxes from a computer). ▶ **Restricting Fax Sending from a Computer(P. 329)**

<Off>  
<On> +

### <Confirm Entered Fax Number>

Select whether to require users to enter the fax number twice when it is entered by using the numeric keys. ▶ **Confirming the Entered Fax Number(P. 329)**

<Off> +  
<On>

### <Restrict Sequential Broadcast>

Select whether to prohibit sequential broadcasting, a feature that sends faxes to multiple destinations in succession. ▶ **Restricting Sequential Broadcasts(P. 329)**

<Off> +  
<Confirm Sequential Broadcast>  
<Reject Sequential Broadcast>

### <Initialize Default Settings>

Select this option to restore the default fax transmission settings.



<Menu> ▶ <Fax Settings> ▶ <TX Function Settings> ▶ <Initialize Default Settings> ▶ <Yes>

## <RX Function Settings>

Specify settings for receiving faxes.

### <ECM RX>

Enable or disable error correction mode (ECM). ECM checks for fax data errors and corrects them. To reduce errors on sent faxes, see ▶ **<ECM TX>(P. 391)** .

<Off>  
<On> +

## NOTE

- ECM must be enabled on both the machine and the other fax device because error check is performed on both the sending and receiving devices.
- Even when ECM is enabled, errors may occur due to telephone line conditions.
- It may take a longer time than usual to process data when ECM is enabled because the error check and corrections are performed while the data is transmitted.



<Menu> ▶ <Fax Settings> ▶ <RX Function Settings> ▶ <ECM RX> ▶ Select <Off> or <On>

### <Incoming Ring>

Specify settings for sounding a ring to notify you of incoming faxes. This feature is only available when <Auto> or <Fax/Tel (Auto Switch)> is selected for the receive mode. Specify how many times the incoming call rings when the machine receives a fax call. You can also disable the settings to prevent the incoming call from ringing.

<Off>

<On> †

1 to 2 † to 99 (times)

## NOTE

- When <On> is specified, you need to connect your telephone to the machine beforehand.
- When <Off> is specified, the machine does not enter sleep mode.



<Menu> ▶ <Fax Settings> ▶ <RX Function Settings> ▶ <Incoming Ring> ▶ <On> ▶ Specify how many times the incoming call rings ▶ <Apply>

### <Remote RX>

Specify settings for receiving a fax by operating a telephone that is connected to the machine (Remote Reception). When a fax is sent to the machine, you can receive it just by picking up the handset of the telephone and entering a specific ID number by using the telephone. This feature can save you the trouble of going all the way to the machine. For instructions on how to use Remote Reception, see **Using a Telephone to Receive Faxes (Remote Reception)(P. 205)** .

<Off>

<On> †

00 to 25 † to 99



<Menu> ▶ <Fax Settings> ▶ <RX Function Settings> ▶ <Remote RX> ▶ <On> ▶ Specify the ID number for receiving a fax ▶ <Apply>

**<Switch to Auto RX>**

Specify settings for automatically receiving a fax after the machine has rung for a specified time period. This feature is only available when <Manual> is selected for the receive mode. By using this feature, faxes can be received even when no one is available to pick up the handset.

<Off> †

<On>  
1 to 15 † to 99 (sec.)



<Menu> ▶ <Fax Settings> ▶ <RX Function Settings> ▶ <Switch to Auto RX> ▶ <On> ▶ Specify how long the incoming call rings ▶ <Apply>

**<Memory Lock Settings>**

Select whether to store received faxes without immediately printing them. Stored fax documents can be printed at any time by changing the setting to <Off>.  **Saving Received Documents into the Machine (Memory Reception)(P. 213)**

<Off> †

<On>  
 <Report Print>  
 <Off>  
 <On> †  
 <Memory Lock Time>  
 <Off> †  
 <On>  
 <Memory Lock Start Time>  
 <Memory Lock End Time>



<Menu> ▶ <Fax Settings> ▶ <RX Function Settings> ▶ <Memory Lock Settings> ▶ <On> ▶ Specify settings ▶ <Apply>

**<RX Print Settings>**

Specify settings for printing received faxes.

### <Print on Both Sides>

Specify settings for printing received faxes on both sides of paper.

<Off> †  
<On>



<Menu> ▶ <Fax Settings> ▶ <RX Print Settings> ▶ <Print on Both Sides> ▶ <On>

### <Reduce RX Size>

Specify settings for reducing the image size of a received document. You can select an automatic reduction ratio that reduces the received document to size of the loaded paper. You can also select a ratio from a list.

<Off>  
<On> †  
  <Ratio>  
    <Auto> †  
    <97%>  
    <95%>  
    <90%>  
    <75%>  
  <Direction>  
    <Vertical/Horizontal>  
    <Vertical Only> †



<Menu> ▶ <Fax Settings> ▶ <RX Print Settings> ▶ <Reduce RX Size> ▶ <On> ▶ Specify the settings  
▶ <Apply>

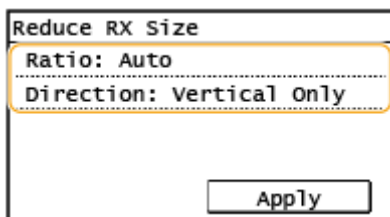

#### <Ratio>

<Auto> reduces the image by a ratio that is based on the size of the loaded paper. <97%>, <95%>, <90%>, or <75%> reduce the image by the corresponding ratio.

#### <Direction>

Select <Vertical/Horizontal> to reduce the image both vertically and horizontally. Select <Vertical Only> to reduce only vertically.

### <RX Page Footer>

Select whether to print information, including date and time of reception and page numbers, on the bottom of received faxes.

<Off> +  
<On>



<Menu> ▶ <Fax Settings> ▶ <RX Print Settings> ▶ <RX Page Footer> ▶ <On>

### <Continue Print. When Near Cart. Life End>

If receiving faxes when the amount remaining in a toner cartridge is nearly empty, the machine holds them in memory instead of printing. However, if this function is enabled, the machine continues printing.

<Off> +  
<On>

## IMPORTANT

When this function is enabled, faxes may fade or blur. Because received documents are not stored in memory, you need to ask the sender to resend the document.



<Menu> ▶ <Fax Settings> ▶ <RX Print Settings> ▶ <Continue Print. When Near Cart. Life End>  
▶ <On>

## <Forwarding Settings>

Specify settings for forwarding faxes.

### <Enable Forwarding Settings>

Select whether to forward all the received fax documents to a specified destination. You can specify an e-mail address or a shared folder in a computer as the forwarding destination. **▶ Forwarding the Received Documents Automatically(P. 215)**

<Off> +  
<On>

### <Print Images>

Select whether to print forwarded fax documents. You can set the machine to print forwarded documents only when an error occurs. **▶ Printing Documents to be Forwarded(P. 215)**

<Off>  
<On> +  
<Only When Error Occurs>

### <Store Images in Memory>

Select whether to store fax documents in memory when they are not successfully forwarded. You can resend or print the documents later as necessary. **▶ Printing/Resending/Deleting Documents that Failed to be Forwarded(P. 215)**

<Off> +

<Only When Error Occurs>

## <Fax Setup Guide>

Select to display on-screen instructions for specifying settings, including the fax number and the telephone line type.

▶ **Configuring Initial Settings for Fax Functions(P. 70)**

## <Scan Settings>

All the settings about the scan are listed with short descriptions. Default settings are marked with a dagger (†).

- ▶<E-Mail Settings>(P. 400)
- ▶<File Settings>(P. 401)
- ▶<Register Unit Name (E-Mail)>(P. 402)
- ▶<Output File Image Settings>(P. 403)
- ▶<Shortcut Key Settings>(P. 403)

### NOTE

#### Asterisks (\*)

- Settings marked with an asterisk (\*) may not be displayed depending on the model you are using.

## <E-Mail Settings> \*

Change the default settings used for scanning originals to send as e-mails.

### <Change Default Settings>

You can change the default settings used for scanning originals to send as e-mails. The selected settings are used as the default settings when scanning originals. ▶<Changing the Default Settings for Functions>(P. 154)

#### <Scan Size>

- <LTR> †
- <LGL>
- <STMT>

#### <Color Mode>

- <Color> †
- <Black & White>

#### <File Format>

- <PDF> †
- <PDF (Compact)>
- <JPEG>
- <TIFF>

#### <Density>

- 9 Levels

#### <Original Orientation>

- <Portrait> †
- <Landscape>

#### <Original Type>

- <Text>
- <Text/Photo> †

- <Photo>
- <2-Sided Original> \***
  - <Off> †
  - <Book Type>
  - <Calendar Type>
- <Sharpness>**
  - 7 Levels
- <Data Size>**
  - <Small: Memory Priority>
  - <Standard> †
  - <Large: Image Quality Priority>
- <Subject/Message>**
  - <Subject>
  - <Message>
- <Reply To>**
  - <None> †
  - <Specify from Address Book>
- <Priority>**
  - <Low>
  - <Standard> †
  - <High>

### <Initialize Default Settings>

Select this option to restore the default e-mail transmission settings.

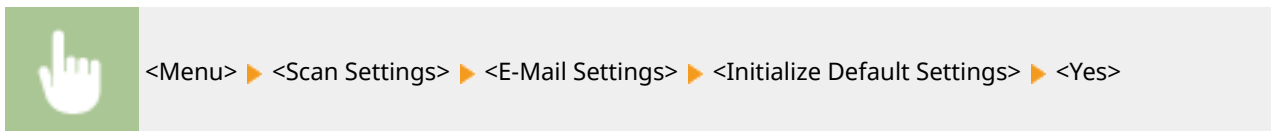

## <File Settings> \*

Change the default settings used when originals are saved to a shared folder.

### <Change Default Settings>

You can change the default settings used when originals are saved to a shared folder. The selected settings are used as the default settings when scanning. ▶ **Changing the Default Settings for Functions(P. 154)**

- <Scan Size>**
  - <LTR> †
  - <LGL>
  - <STMT>
- <Color Mode>**



<Color> †
<Black & White>
<b>&lt;File Format&gt;</b>
<PDF> †
<PDF (Compact)>
<JPEG>
<TIFF>
<b>&lt;Density&gt;</b>
9 Levels
<b>&lt;Original Orientation&gt;</b>
<Portrait> †
<Landscape>
<b>&lt;Original Type&gt;</b>
<Text>
<Text/Photo> †
<Photo>
<b>&lt;2-Sided Original&gt; *</b>
<Off> †
<Book Type>
<Calendar Type>
<b>&lt;Sharpness&gt;</b>
7 Levels
<b>&lt;Data Size&gt;</b>
<Small: Memory Priority>
<Standard> †
<Large: Image Quality Priority>

### <Initialize Default Settings>

You can change and register the settings used when documents are saved to a shared folder.

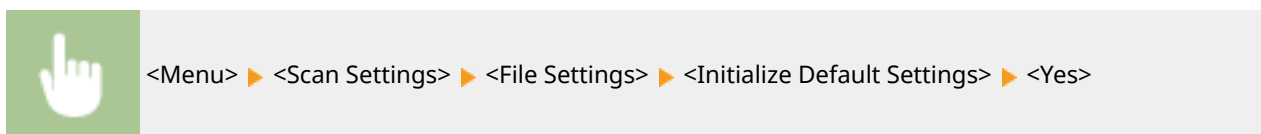

### <Register Unit Name (E-Mail)> \*

Register the sender name for e-mails. The registered name is displayed in e-mails, along with the e-mail address. If the sender name is not registered, only the e-mail address is displayed.



<Menu> ▶ <Scan Settings> ▶ <Register Unit Name (E-Mail)> ▶ Enter the sender name ▶ <Apply>

## <Output File Image Settings> \*

Specify settings for the gamma value for converting scanned originals into files.

### <YCbCr TX Gamma Value>

Select the gamma value used when converting scanned color documents into the specified file format. You can specify the same gamma value as that of the monitor which is to be used for viewing the converted files. The files are displayed with brightness that is true to the original documents.

- <Gamma 1.0>
- <Gamma 1.4>
- <Gamma 1.8> †
- <Gamma 2.2>



<Menu> ▶ <Scan Settings> ▶ <Output File Image Settings> ▶ <YCbCr TX Gamma Value> ▶ Select the gamma value

## <Shortcut Key Settings>

Register scan settings for the <Scan -> PC1> and <Scan -> PC2> buttons or  key. The settings include the computer that scanned images are saved in, the type of scan (color or black and white), and the file format (PDF or JPEG). Registering these settings enables you to scan documents into a specified computer just by pressing a button. You can view the registered settings by selecting <Confirm Destination>. **▶ Scanning Using the Shortcut Key(P. 236)**

### Touch Panel Model

- <Register>
  - <Scan -> PC1>
    - <Off> †
    - <USB Connection>
      - <Color Scan>
      - <B&W Scan>
      - <Custom 1>
      - <Custom 2>
    - <Network Connection>
      - <Color Scan>
      - <B&W Scan>
      - <Custom 1>
      - <Custom 2>
  - <Scan -> PC2>
    - <Off> †

<USB Connection>  
    <Color Scan>  
    <B&W Scan>  
    <Custom 1>  
    <Custom 2>  
<Network Connection>  
    <Color Scan>  
    <B&W Scan>  
    <Custom 1>  
    <Custom 2>

**<Confirm Destination>**

<Scan -> PC1>  
<Scan -> PC2>

## 5 Lines LCD Model

**<Register>**

<Scan -> PC>  
<Off> †  
<USB Connection>  
    <Color Scan>  
    <B&W Scan>  
    <Custom 1>  
    <Custom 2>  
<Network Connection>  
    <Color Scan>  
    <B&W Scan>  
    <Custom 1>  
    <Custom 2>

**<Confirm Destination>**

<Scan -> PC>

## <Printer Settings>

All the settings related to the printer are listed with descriptions. Default settings are marked with a dagger (†).

- ▶<Action When Paper Size Mismatch> (P. 405)
- ▶<Image Quality Settings for Mobile Print>(P. 405)
- ▶<Copies>(P. 406)
- ▶<2-Sided Printing>(P. 406)
- ▶<Default Paper>(P. 406)
- ▶<Print Quality>(P. 407)
- ▶<Layout>(P. 408)
- ▶<Timeout>(P. 409)
- ▶<PCL>(P. 409)

### NOTE

#### Asterisks (\*)

- Settings marked with (\*) may be unavailable or vary or have different defaults depending on your country or region.

#### Priority of settings

- If a print setting is specified both from the printer driver and the operation panel of the machine, the specification from the printer driver overrides that from the operation panel. The specification from the operation panel becomes effective in some specific cases, such as when printing from UNIX or other operating system that does not support printer drivers.



### <Action When Paper Size Mismatch>

Set whether printing goes ahead if a paper size other than the size loaded in the drawer is selected. You can also set the machine not to go ahead with printing and instead display an alert message.

<Force Output>  
<Display Error> †



<Menu> (  ) ▶ <Printer Settings> ▶ <Action When Paper Size Mismatch> ▶ Select <Force Output> or <Display Error>

### <Image Quality Settings for Mobile Print>

Select the image processing when printing from a mobile device.

**<Halftone>**

<Gradation> †  
<Error Diffusion>

**<Priority>**

<Speed Priority>  
<Image Quality Priority> †



<Menu> (  ) ▶ <Printer Settings> ▶ <Image Quality Settings for Mobile Print> ▶ Select <Halftone> or <Priority> ▶ Select the item ▶ <Apply>

## NOTE



- When <Priority> is set to <Speed Priority>, you cannot select <Error Diffusion>.

## <Copies>

Set the number of copies to print.

1 † to 999



<Menu> (  ) ▶ <Printer Settings> ▶ <Copies> ▶ Set the number of copies to print ▶ <Apply>  
(  )

## <2-Sided Printing>

Select whether to make 2-sided printouts.

<Off> †  
<On>



<Menu> (  ) ▶ <Printer Settings> ▶ <2-Sided Printing> ▶ Select <Off> or <On>

## <Default Paper>

Use this item to specify the paper size. ▶ **Available Paper(P. 538)**



<Menu> (  ) ▶ <Printer Settings> ▶ <Default Paper> ▶ Select the paper size

## <Print Quality>

You can change settings related to print quality.

### <Density>

Adjust the toner density.

**17 Levels**

**<Fine Adjust>/<Density (Fine Adjust)>**

<High>  
17 Levels

<Medium>  
17 Levels

<Low>  
17 Levels

**NOTE**

- The settings specified for <Density> are disabled when <Toner Save> is enabled.



<Menu> (  ) ▶ <Printer Settings> ▶ <Print Quality> ▶ <Density> ▶ Adjust the density ▶ <Apply>

### <Toner Save>

You can save toner consumption when printing from a mobile device. Select <On> when you want to check the layout or other appearance characteristics before proceeding to final printing of a large job.

<Off> <sup>+</sup>

<On>



<Menu> (  ) ▶ <Printer Settings> ▶ <Print Quality> ▶ <Toner Save> ▶ Select <Off> or <On>

### <Resolution>

Specify the resolution to be used for print data processing.

<1200 dpi>



<600 dpi> <sup>+</sup>

 <Menu> (  ) ▶ <Printer Settings> ▶ <Print Quality> ▶ <Resolution> ▶ Select <1200 dpi> or <600 dpi>

### <Density Fine Adjustment>

Finely adjust the density. You can specify this setting only when <1200 dpi> is selected in <Resolution>.

<-1>  
 <0> †  
 <+1>

 <Menu> (  ) ▶ <Printer Settings> ▶ <Print Quality> ▶ <Density Fine Adjustment> ▶ Specify the density



## <Layout>

Specify the page layout settings such as binding position.

### <Binding Location>

If you are binding the printouts with a binding tool such as a stapler, use this item to specify whether to bind on the long or short edge.

<Long Edge> †  
 <Short Edge>

 <Menu> (  ) ▶ <Printer Settings> ▶ <Layout> ▶ <Binding Location> ▶ Select <Long Edge> or <Short Edge>

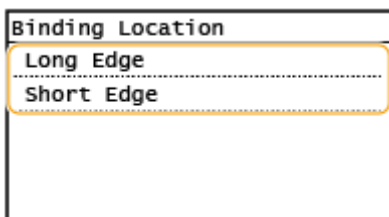

#### <Long Edge>

Specify this to bind on the long edge of paper.



#### <Short Edge>

Specify this to bind on the short edge of paper.





## <Timeout>

Set the time period after which the current print job is automatically canceled in the case of a print data reception interruption.

5 to 15 + to 300 (sec.)



<Menu> (  ) ▶ <Printer Settings> ▶ <Timeout> ▶ Set the time period ▶ <Apply> (  )

## <PCL>

Specify the PCL printing settings such as page layout and print quality.

### <Paper Save>

Select whether to save paper by not outputting blank pages in documents. By selecting <On>, the machine will not output blank pages. To output all your document data when printing, including any blank pages that you have inserted in your document, select <Off>.

<Off> +  
<On>



<Menu> (  ) ▶ <Printer Settings> ▶ <PCL> ▶ <Paper Save> ▶ Select <Off> or <On>

### <Orientation>

Select <Portrait> (vertical orientation) or <Landscape> (horizontal orientation) for the page orientation.

<Portrait> +  
<Landscape>



<Menu> (  ) ▶ <Printer Settings> ▶ <PCL> ▶ <Orientation> ▶ Select <Portrait> or <Landscape>





**<Font Number>**

Specify the font to use by selecting a corresponding font ID number. You can print the PCL font list with font samples from the operation panel.  **PCL Font List(P. 458)**

0  to 54



<Menu> (  ) ▶ <Printer Settings> ▶ <PCL> ▶ <Font Number> ▶ Select the font number  
▶ <Apply> (  )

**<Point Size>**

Set the font size in points, adjustable in 0.25 increments. You can specify this setting only when a proportionally-spaced scalable font is selected in <Font Number>.

4.00 to 12.00  to 999.75 (point)



<Menu> (  ) ▶ <Printer Settings> ▶ <PCL> ▶ <Point Size> ▶ Specify the point size ▶ <Apply>  
(  )

**<Pitch>**

Set the font pitch, or cpi (characters per inch), adjustable in 0.01 increments. You can specify this setting only when a fixed-pitch scalable font or a bitmap font is selected in <Font Number>.

0.44 to 10.00  to 99.99 (cpi)





<Menu> (  ) ▶ <Printer Settings> ▶ <PCL> ▶ <Pitch> ▶ Specify the pitch value ▶ <Apply> (  )

**<Form Lines> \***

Set the number of lines printed on one page from 5 to 128. This setting is automatically changed according to the settings specified in <Default Paper Size> and <Orientation>.

5 to 60  to 128 (lines)



<Menu> (  ) ▶ <Printer Settings> ▶ <PCL> ▶ <Form Lines> ▶ Specify the number of lines  
▶ <Apply> (  )

**<Character Code>**

Select the character code that is most suited for the computer you send print data from. The specified setting is ignored when the character code is controlled by the font specified in <Font Number>.

<DESKTOP>	<PC8> †
<ISO4>	<PC850>
<ISO6>	<PC852>
<ISO11>	<PC8DN>
<ISO15>	<PC8TK>
<ISO17>	<PC1004>
<ISO21>	<PIFONT>
<ISO60>	<PSMATH>
<ISO69>	<PSTEXT>
<ISOL1>	<ROMAN8>
<ISOL2>	<VNINTL>
<ISOL5>	<VNMATH>
<ISOL6>	<VNUS>
<LEGAL>	<WIN30>
<MATH8>	<WINBALT>
<MCTEXT>	<WINL1>
<MSPUBL>	<WINL2>
<PC775>	<WINL5>

 <Menu> (  ) ▶ <Printer Settings> ▶ <PCL> ▶ <Character Code> ▶ Select the character code

**<Custom Paper>**

Select whether to set a custom paper size. Select <On> to set the dimensions of the paper in <X dimension> and <Y dimension>.



<Off> †
<On>

 <Menu> (  ) ▶ <Printer Settings> ▶ <PCL> ▶ <Custom Paper> ▶ Select <Off> or <On>

**<Unit of Measure> \***

Select the unit of measurement to use to set a custom paper size.



<Millimeters>
<Inches> †

 <Menu> (  ) ▶ <Printer Settings> ▶ <PCL> ▶ <Unit of Measure> ▶ Select <Millimeters> or <Inches>

**<X dimension>**

Specify the horizontal dimension (short edge) of the custom paper.



3 to 8 1/2 † (inches) or 77 to 215 † (mm)

 <Menu> (  ) ▶ <Printer Settings> ▶ <PCL> ▶ <X dimension> ▶ Specify the dimension ▶ <Apply> (  )

**<Y dimension>**

Specify the vertical dimension (long edge) of the custom paper.

5 to 14 † (inches) or 127 to 355 † (mm)

 <Menu> (  ) ▶ <Printer Settings> ▶ <PCL> ▶ <Y dimension> ▶ Specify the dimension ▶ <Apply> (  )

**<Append CR to LF>**

Select whether to append a carriage return (CR) when the machine receives a line feed code (LF). If <Yes> is selected, the print position moves to the beginning of the next line when the machine receives an LF code. If <No> is selected, the print position moves to the next line, just under the received LF code.

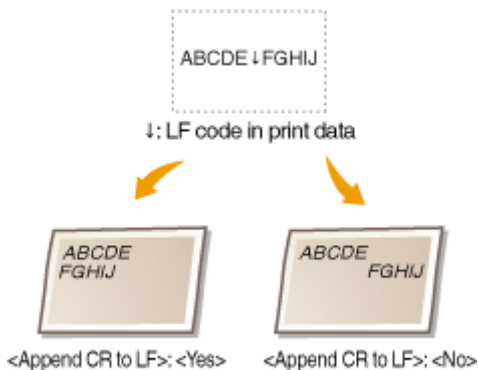

<Yes>  
<No> †

 <Menu> (  ) ▶ <Printer Settings> ▶ <PCL> ▶ <Append CR to LF> ▶ Select <Yes> or <No>

### <Enlarge A4 Print Width>

Select whether to expand the width of the printable area of A4 size paper in portrait orientation to that of LTR size.

<Off> †  
<On>

 <Menu> (  ) ▶ <Printer Settings> ▶ <PCL> ▶ <Enlarge A4 Print Width> ▶ Select <Off> or <On>

### <Halftones>

You can select the printing method to reproduce halftones (the intermediate range between the lighter and darker areas of an image) for optimal image quality. For each document, you can make settings by type of image.

**<Text>**  
<Color Tone>  
<Gradation>  
<Resolution> †

**<Graphics>**  
<Color Tone> †  
<Gradation>  
<Resolution>

**<Image>**  
<Color Tone> †  
<Gradation>  
<Resolution>

 <Menu> (  ) ▶ <Printer Settings> ▶ <PCL> ▶ <Halftones> ▶ Select the type of image ▶ Select the halftone reproduction method

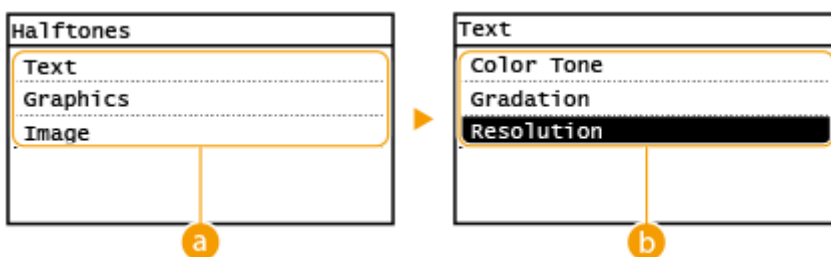

**a Type of image**

Select the object for which to change the setting. <Text> represents letters and characters, <Graphics> represents lines and figures, and <Image> represents photos and images.

**b Setting value****<Color Tone>**

Produces a sharp print with strong contrast of lightness and darkness. It is suitable for printing image data such as photo image data.

**<Gradation>**

Produces a print with smooth gradation or smooth edges. It is suitable for printing figures or graphs containing gradation areas.

**<Resolution>**

Produces a fine print with clear edges of text. It is suitable for printing characters and fine lines.

**<Feed A5 Horizontally>**

Enable or disable horizontal feeding when printing A5 size.

<Off> +  
<On>



<Menu> (  ) ▶ <Printer Settings> ▶ <PCL> ▶ <Feed A5 Horizontally> ▶ Select <Off> or <On>

## <Adjustment/Maintenance>

All the settings related to adjustment and maintenance are listed with descriptions. Default settings are marked with a dagger ( † ).

▶<Displ. Timing for Cartridge Prep. Notif.>(P. 415)

▶<Toner Save>(P. 415)

▶<Special Processing>(P. 416)

▶<Clean Fixing Assembly>(P. 419)

▶<Control Condensation>(P. 420)

### NOTE

#### Asterisks ( † )



- Settings marked with an asterisk ( † ) may not be displayed depending on the model you are using.

### <Displ. Timing for Cartridge Prep. Notif.>

Set the display timing for the message notifying you that the amount remaining in the toner cartridge or the drum cartridge is low.

<Toner Cartridge>  
<Drum Cartridge>



<Menu> (  ) ▶ <Adjustment/Maintenance> ▶ <Displ. Timing for Cartridge Prep. Notif.> ▶ Select <Toner Cartridge> or <Drum Cartridge> ▶ Enter the cartridge level ▶ <Apply> (  )

### <Toner Save>

Select whether to reduce toner consumption when copying or faxing.

<Copy>  
<Off> †  
<On>  
  
<Fax> \*  
<Off> †  
<On>



<Menu> (  ) ▶ <Adjustment/Maintenance> ▶ <Toner Save> ▶ Select <Copy> or <Fax> ▶ <On>

**NOTE:**

When set to <On>

- Fine lines and portions with lighter print density may become blurred.

<Special Processing>

If the print results on special types of paper are not satisfactory, the following settings may improve the quality of the printouts.

**<Special Printing Mode U>**

Sometimes toner appears splattered around text or patterns in a printout. In such cases, setting this to <On> may improve the quality of the printout.

<Off> +  
<On>

<Menu> ( ) ▶ <Adjustment/Maintenance> ▶ <Special Processing> ▶ <Special Printing Mode U>  
▶ <On>

**NOTE**

- Setting this to <On> may affect the print quality for some types of paper (especially for lightweight paper) or in some printing environments (especially in high humidity environments).
- When you set this to <On>, <Special Printing Mode Q>, <Special Printing Mode R>, and <Special Printing Mode T> are set to <Off> automatically.

**<Special Printing Mode D>**

Set this item when the printed paper turns out grayish or printing is faded.

<Off> +  
<On>

<Menu> ( ) ▶ <Adjustment/Maintenance> ▶ <Special Processing> ▶ <Special Printing Mode D>  
▶ <On>

**<Special Printing Mode A>**

If streaks adhere to the print paper, changing this may improve the print quality. <Mode 2> can improve the quality more significantly than <Mode 1>.

<Off> +  
<Mode 1>  
<Mode 2>



<Menu> (  ) ▶ <Adjustment/Maintenance> ▶ <Special Processing> ▶ <Special Printing Mode A>  
▶ Select the mode

### <Special Printing Mode Z>

If streaks adhere to the print paper output when copying or faxing, changing this may improve the print quality. <Mode 2> can improve the quality more significantly than <Mode 1>.

#### Touch Panel Model

**<Copy>**  
 <Off> †  
 <Mode 1>  
 <Mode 2>

**<Fax>**  
 <Off> †  
 <Mode 1>  
 <Mode 2>

#### 5 Lines LCD Model

<Off> †  
 <Mode 1>  
 <Mode 2>

#### Touch Panel Model



<Menu> ▶ <Adjustment/Maintenance> ▶ <Special Processing> ▶ <Special Printing Mode Z> ▶  
Select <Copy> or <Fax> ▶ Select the mode

#### 5 Lines LCD Model





 ▶ <Adjustment/Maintenance> ▶ <Special Processing> ▶ <Special Printing Mode Z> ▶ Select the mode

### <Special Printing Mode G>

Printed images may fade or streaks may appear when the paper has a lot of paper dust. In such cases, setting this to <On> may improve the quality of the printout.

<Off> †  
 <On>





 <Menu> (  ) ▶ <Adjustment/Maintenance> ▶ <Special Processing> ▶ <Special Printing Mode G> ▶ <On>

### <Special Printing Mode Q>

Printed images may be faint when they are printed on rough-surface paper. In such cases, setting this to <On> may improve the quality of the printout.

<Off> +  
<On>

 <Menu> (  ) ▶ <Adjustment/Maintenance> ▶ <Special Processing> ▶ <Special Printing Mode Q> ▶ <On>



## NOTE

- Setting this to <On> may affect the image quality.
- When you set this to <On>, <Special Printing Mode U>, <Special Printing Mode R>, and <Special Printing Mode T> are set to <Off> automatically.

### <Special Printing Mode R>

Printing may be faint when you print on the back of a printed sheet. In such cases, setting this to <On> may improve the quality of the printout.

<Off> +  
<On>

 <Menu> (  ) ▶ <Adjustment/Maintenance> ▶ <Special Processing> ▶ <Special Printing Mode R> ▶ <On>

## NOTE

- If you set to <On>, image quality may be affected or a paper jam may occur when a certain length of time elapses after printing on the front side or depending on the ambient humidity.
- When you set this to <On>, <Special Printing Mode U>, <Special Printing Mode Q>, and <Special Printing Mode T> are set to <Off> automatically.

### <Special Printing Mode T>

Printing may be uneven when you print in a high-humidity environment. In such cases, setting this to <On> may improve the quality of the printout.

<Off> †  
<On>



<Menu> (  ) ▶ <Adjustment/Maintenance> ▶ <Special Processing> ▶ <Special Printing Mode T>  
▶ <On>

## NOTE

- Printed images or text may be blurred when you set this to <On> and print in a low-humidity environment.
- When you set this to <On>, <Special Printing Mode U>, <Special Printing Mode Q>, and <Special Printing Mode R> are set to <Off> automatically.

### <Special Printing Mode L>

Smudges may appear in a printout when the paper has a lot of paper dust or other dust particles. In such cases, setting this to <On> may improve the quality of the printout.

<Off> †  
<On>



<Menu> (  ) ▶ <Adjustment/Maintenance> ▶ <Special Processing> ▶ <Special Printing Mode L>  
▶ <On>

### <Select Line Width>

If a printed barcode cannot be read, changing this may resolve the problem.

<Auto> †  
<Thin>  
<Slightly Thin>  
<Slightly Thick>  
<Thick>



<Menu> (  ) ▶ <Adjustment/Maintenance> ▶ <Special Processing> ▶ <Select Line Width>  
▶ Select the line width

## <Clean Fixing Assembly>

Clean the fixing assembly after the toner cartridge or the drum cartridge is replaced or if black streaks appear on printouts.  **Cleaning the Fixing Assembly(P. 439)**

**<Control Condensation> \***

Restrict fax and print operation while removing condensation that has formed due to changes in the environment.

**<Off> †**

**<On>**

<Use Fax Memory Lock>

<Use Fax Mem. Lock+Do Not Allow Job Print>



<Menu> ▶ <Adjustment/Maintenance> ▶ <Control Condensation> ▶ <On> ▶ <OK> ▶ Select <Use Fax Memory Lock> or <Use Fax Mem. Lock+Do Not Allow Job Print> ▶ <Yes>

**NOTE**

- While condensation is being removed, blurred images may be printed and print density may decrease.
- When the machine is removing condensation, it does not enter sleep mode.

## <System Management Settings>

2KUU-07X

All the settings related to System Management Settings are listed with descriptions. Default settings are marked with a dagger ( †).

- ▶<Network Settings>(P. 421)
- ▶<System Manager Information Settings>(P. 421)
- ▶<Device Information Settings>(P. 422)
- ▶<Security Settings>(P. 422)
- ▶<Select Country/Region>(P. 423)
- ▶<Remote UI Settings>(P. 423)
- ▶<Auto Online for Remote Scan>(P. 424)
- ▶<Restrict TX Function>(P. 424)
- ▶<Display Job Log>(P. 425)
- ▶<Use as USB Device>(P. 425)
- ▶<Enable Product Extended Survey Program>(P. 425)
- ▶<Displ. Consmbls. Info (RUI/Toner Status)>(P. 426)
- ▶<Google Cloud Print Settings>(P. 426)
- ▶<Import/Export Address Book>(P. 427)
- ▶<PDL Selection (Plug and Play)>(P. 427)
- ▶<Update Firmware>(P. 428)
- ▶<Initialize Address Book>(P. 428)
- ▶<Initialize Eco Report Counter>(P. 428)
- ▶<Initialize Menu>(P. 428)
- ▶<Initialize All Data/Settings>(P. 428)

### NOTE

#### Asterisks (\*)

- Settings marked with "\*"1" may be unavailable or vary or have different defaults depending on your country or region.
- Settings marked with "\*"2" may not be displayed depending on the model you are using, or other setting items.

### <Network Settings>

See ▶<Network Settings>(P. 363) .

### <System Manager Information Settings>

Specify the PIN exclusively for Administrators who have access privileges to <Network Settings> and <System Management Settings>. You can set the PIN from <System Manager PIN>. You can also register the name of an Administrator. ▶<Setting the System Manager PIN(P. 293)>

#### <System Manager PIN>

Enter a number for the System Manager PIN.

### <System Manager Name>



Enter alphanumeric characters for the name of an Administrator.

### <Device Information Settings>

Enter alphanumeric characters for the name and the installation location to identify the machine.

<Device Name>  
<Location>



<Menu> (  ) ▶ <System Management Settings> ▶ <Device Information Settings> ▶ Select <Device Name> or <Location> ▶ Enter the device name or location (  **Entering Text(P. 123)** ) ▶ <Apply>

### <Security Settings>

Enable or disable settings for IP address or MAC address packet filtering.

#### <Use TLS>

Select whether to use the TLS encrypted communication.  **Configuring the Key and Certificate for TLS(P. 308)**

<Off> †  
<On>

#### <IPv4 Address Filter>

Enable or disable settings for filtering packets received from devices with specified IPv4 addresses.  **Specifying IP Addresses for Firewall Settings(P. 300)**

<Inbound Filter>  
<Off> †  
<On>



<Menu> (  ) ▶ <System Management Settings> ▶ <Security Settings> ▶ <IPv4 Address Filter> ▶ <Inbound Filter> ▶ Select <Off> or <On>

#### <IPv6 Address Filter>

Enable or disable settings for filtering packets received from devices with specified IPv6 addresses.  **Specifying IP Addresses for Firewall Settings(P. 300)**

< Inbound Filter>  
<Off> †  
<On>



<Menu> (  ) ▶ <System Management Settings> ▶ <Security Settings> ▶ <IPv6 Address Filter> ▶ <Inbound Filter> ▶ Select <Off> or <On>

### <MAC Address Filter>

Enable or disable settings for filtering packets received from devices with specified MAC addresses. ▶ **Specifying MAC Addresses for Firewall Settings(P. 303)**

#### <Inbound Filter>

<Off> †

<On>



<Menu> (  ) ▶ <System Management Settings> ▶ <Security Settings> ▶ <MAC Address Filter> ▶ <Inbound Filter> ▶ Select <Off> or <On>

### <Select Country/Region> \*1

Specify the country or region where the machine is used. The default setting may vary depending on the setting selected at initial power-on.

<United States (US)>

<Canada (CA)>

<Brazil (BR)>

<Mexico (MX)>

<Other>



<Menu> (  ) ▶ <System Management Settings> ▶ <Select Country/Region> ▶ Select a country or region

### <Remote UI Settings>

Configure settings for using the Remote UI. Using the Remote UI allows you to configure machine settings from a Web browser.

#### <Use Remote UI>

Select whether to use the Remote UI. ▶ **Disabling Remote UI(P. 333)**

<Off>

<On> †



<Menu> (  ) ▶ <System Management Settings> ▶ <Remote UI Settings> ▶ <Use Remote UI>  
▶ Select <Off> or <On>

### <Remote UI Access Security Settings>

Specify so that entry of a PIN is required for access to the Remote UI. Set a PIN of up to 7 digits. All users use a common PIN.  **Setting a Remote UI PIN(P. 295)**

<Off> †

<On>  
<Remote UI Access PIN>





<Menu> (  ) ▶ <System Management Settings> ▶ <Remote UI Settings> ▶ <Remote UI Access Security Settings> ▶ <On> ▶ Enter a PIN ▶ <Apply> ▶ Enter the PIN (Confirm) ▶ <Apply>

### <Auto Online for Remote Scan>

Select whether to use this feature to go online for remote scanning, even without using the operation panel.

<Off>  
<On> †



<Menu> (  ) ▶ <System Management Settings> ▶ <Auto Online for Remote Scan> ▶ Select <Off> or <On>

### <Restrict TX Function> \*2

Specify settings for restricting access to sending functions for selected destinations.

#### <Address Book PIN>

Specify a PIN and require entering it to add new entries to or edit existing entries in the Address Book.  **Restricting Use of the Address Book(P. 325)**

#### <Restrict New Destinations>

Select whether to limit the fax numbers and e-mail addresses that can be specified as destinations to those already registered in the Address Book.  **Limiting Available Destinations(P. 327)**

<Off> †  
<On>

### <Restrict Resending from Log>

Select whether to prevent a destination from being selected from the sent job logs. **▶Disabling Use of Previously Used Destinations(P. 327)**

<Off> +  
<On>

### <One-Touch/Coded Dial TX Confirmation>

Select whether to display the details of an entered coded dial number when it is selected as a destination. **▶Displaying Destinations in Address Book(P. 327)**

<Off> +  
<On>

## <Display Job Log>

Select whether to display the copying, printing, faxing, and scanning logs on the display of the machine and in the Communication Management Report.

<Off>  
<On> +



<Menu> (  ) ▶ <System Management Settings> ▶ <Display Job Log> ▶ Select <Off> or <On>

## <Use as USB Device>

Enable or disable the USB port that is used for connecting the machine to a computer. **▶Restricting the USB Connection with a Computer(P. 331)**

<Off>  
<On> +

## <Enable Product Extended Survey Program>

Enable or disable the Product Extended Survey Program (a program for the machine usage survey).

<Off>  
<On> +



<Menu> (  ) ▶ <System Management Settings> ▶ <Enable Product Extended Survey Program> ▶ Select <Off> or <On>



## <Displ. Consmbls. Info (RUI/Toner Status)>

Set whether to display a button in the Remote UI or Toner Status for accessing the Web site for purchasing toner cartridges, etc. Also set whether to use Toner Status.

**<Displ. Consumables Purchase Button (RUI)>**  
 <Off>  
 <On> †

**<Toner Status Settings>**  
 <Off>  
 <On> †  
     <Displ. Purchase Button>  
         <Off>  
         <On> †

<Menu> ( ) ▶ <System Management Settings> ▶ <Displ. Consmbls. Info (RUI/Toner Status)> ▶

Specify the settings

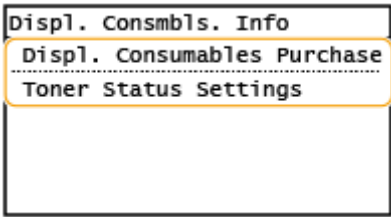

**<Displ. Consumables Purchase Button (RUI)>**  
 Select <Off> to prevent a button that accesses sites for purchasing toner cartridges, etc. from being displayed in the Remote UI.

**<Toner Status Settings>**  
 If you do not want to use Toner Status, select <Off>. To prevent a button that accesses sites for purchasing toner cartridges, etc. from being displayed in Toner Status, select <On> and then <Off>.

## <Google Cloud Print Settings>

Enable or disable Google Cloud Print. **Registering the Machine with Google Cloud Print(P. 286)**

**<Enable Google Cloud Print>**  
 <Off>  
 <On> †

**<Google Cloud Print Registration Status>**

## <Import/Export Address Book> \*2

You can import an Address Book from a computer or export an Address Book from the machine. **▶Importing/Exporting Address Book Data with the Supplied Software(P. 353)**

## <PDL Selection (Plug and Play)>

Select a page description language so that the machine is detected as a printer that is compatible with that language when it is connected to a computer by using Plug and Play.

### <Network>

Select a page description language so that the machine is detected as a printer that is compatible with that language when it is detected over the network.

- <FAX>\*2
- <UFRII LT> †
- <UFRII LT (V4)>
- <PCL6>
- <PCL6 (V4)>

### <USB>

Select a page description language so that the machine is detected as a printer that is compatible with that language when it is connected to a computer via USB.

- <UFRII LT> †
- <UFRII LT (V4)>
- <PCL6>
- <PCL6 (V4)>



<Menu> (  ) ▶ <System Management Settings> ▶ <PDL Selection (Plug and Play)> ▶ Select <Network> or <USB> ▶ Select a page description language ▶ Restart the machine

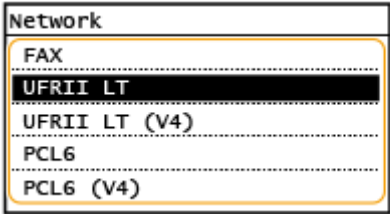

<FAX> \*2  
Detects and connects the machine as a fax device.

<UFRII LT>  
Detects and connects the machine as a UFRII printer.

<UFRII LT (V4)>  
Detects and connects the machine as a UFRII printer that is compatible with XML Paper Specification (XPS).

<PCL6>  
Detects and connects the machine as a PCL6 printer.

**<PCL6 (V4)>**

Detects and connects the machine as a PCL6 printer.

**<Update Firmware>**

Select how to install the firmware update according to the environment of the machine. **▶Updating the Firmware(P. 355)**

<Via PC>  
<Via Internet>  
<Version Information>

**<Initialize Address Book> \*2**

Select to restore the Address Book settings to the factory defaults. **▶Initializing Address Book(P. 359)**

**<Initialize Eco Report Counter>**

Select to restore the Eco Report Counter settings to the factory defaults. **▶Initializing Eco Report Counter(P. 358)**

**<Initialize Menu>**

Select to restore the settings listed below to the factory defaults. You can restore all the settings listed below at once, or you can restore individual settings separately. **▶Initializing Menu(P. 358)**

<Preferences>  
<Timer Settings>  
<Common Settings>  
<Copy Settings>  
<Fax Settings>\*2  
<Scan Settings>  
<Printer Settings>  
<Adjustment/Maintenance>  
<System Management Settings>  
<Initialize All>

**<Initialize All Data/Settings>**

Restores all data including logs and setting values to their default settings. **▶Initializing All Data/Settings(P. 359)**

# Maintenance

<b>Maintenance</b> .....	430
<b>Regular Cleaning</b> .....	432
Cleaning the Exterior .....	433
Cleaning the Platen Glass .....	434
Cleaning the Feeder .....	435
Cleaning the Fixing Assembly .....	439
Cleaning the Machine Interior .....	440
<b>Replacing the Toner Cartridge</b> .....	443
<b>Replacing the Drum Cartridge</b> .....	447
<b>Checking the Remaining Amount of Consumables</b> .....	451
<b>Relocating the Machine</b> .....	452
<b>Viewing the Counter Value</b> .....	454
<b>Printing Reports and Lists</b> .....	455
<b>Consumables</b> .....	460

# Maintenance

---

2KUU-07Y

This chapter describes upkeep of the machine, including how to clean the machine and adjustment of print quality.

## ■ Basic Cleaning



▶ Regular Cleaning(P. 432)

## ■ Replacing Consumables

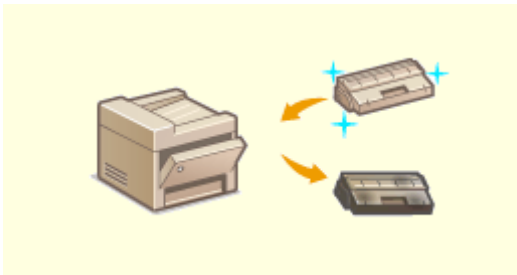

▶ Replacing the Toner Cartridge(P. 443)  
▶ Replacing the Drum Cartridge(P. 447)



▶ Checking the Remaining Amount of Consumables(P. 451)



▶ Consumables(P. 460)

■ Adjusting and Managing the Machine

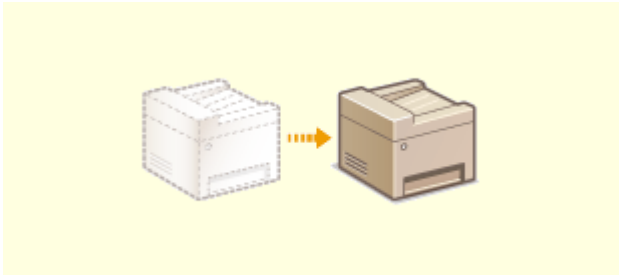

▶ Relocating the Machine(P. 452)

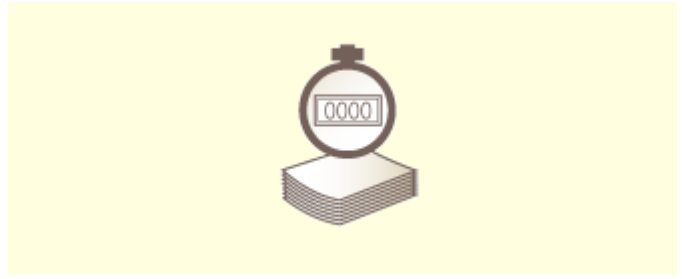

▶ Viewing the Counter Value(P. 454)



▶ Printing Reports and Lists(P. 455)

## Regular Cleaning

2KUU-080

Regularly clean the machine to prevent deterioration in printing quality and to ensure that you use it safely and easily.

### Where to Clean

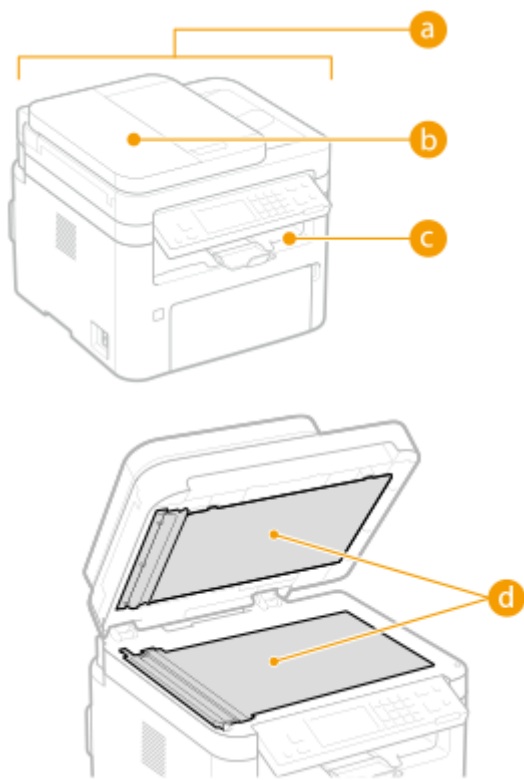

**a** Exterior of the machine and ventilation slots

▶ **Cleaning the Exterior(P. 433)**

**b** Feeder

▶ **Cleaning the Feeder(P. 435)**

**c** Interior of the machine and fixing assembly

▶ **Cleaning the Fixing Assembly(P. 439)**

▶ **Cleaning the Machine Interior(P. 440)**

**d** Platen glass and the underside of the feeder

▶ **Cleaning the Platen Glass(P. 434)**

## Cleaning the Exterior

---

2KUU-081

Regularly wipe the exterior of the machine, especially around the ventilation slots, to keep the machine in good condition.

### 1 Turn OFF the machine, and unplug the power cord from the AC power outlet.

- Turning the printer OFF erases any queued print data. Data such as documents received and held in memory, documents waiting to be sent, and reports that are automatically printed after sending or receiving faxes are not deleted.

### 2 Clean the exterior of the machine and the ventilation slots.

- Use a soft, well-wrung-out cloth dampened with water or a mild detergent diluted with water.
- To locate the ventilation slots, see [▶Front Side\(P. 95\)](#) .



### 3 Wait for the exterior of machine to dry completely.

### 4 Reconnect the power cord and turn ON the machine.



## Cleaning the Platen Glass

2KUU-082

Regularly wipe off the dust from the platen glass and the underside of the feeder to prevent smudges to be printed on originals or printouts.

### 1 Turn OFF the machine, and unplug the power cord from the AC power outlet.

- Turning the printer OFF erases any queued print data. Data such as documents received and held in memory, documents waiting to be sent, and reports that are automatically printed after sending or receiving faxes are not deleted.

### 2 Open the feeder.

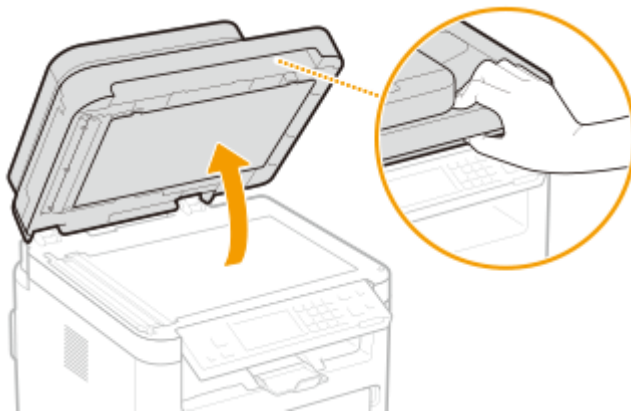

### 3 Clean the platen glass and the underside of the feeder.

- Clean the areas with a cloth dampened with water. Then, wipe the area with a soft, dry cloth.



### 4 Wait for the cleaned area to dry completely.

### 5 Gently close the feeder.

### 6 Reconnect the power cord and turn ON the machine.

# Cleaning the Feeder

2KUU-083

Graphite powder or dust on the rollers inside the feeder or on the original scanning area may cause smudges to appear on printouts. If this occurs or if a paper jam occurs frequently, clean the feeder.

## NOTE

### Feeder scan area cleaning notification

- To display a message for soiling on the original scanning area, <Menu> (  ) ▶ <Preferences> ▶ <Display Settings> ▶ <Notify to Clean Original Scanning Area> ▶ <On>.

### 1 Turn off the machine and unplug it from the power outlet.

- Turning the printer OFF erases any queued print data. Data such as documents received and held in memory, documents waiting to be sent, and reports that are automatically printed after sending or receiving faxes are not deleted.

### 2 Open the original supply tray.

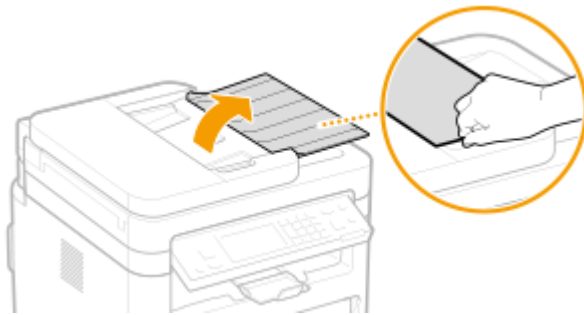

### 3 Open the feeder cover.

MF269dw

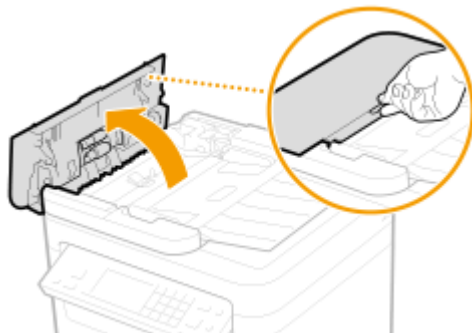

MF267dw / MF264dw

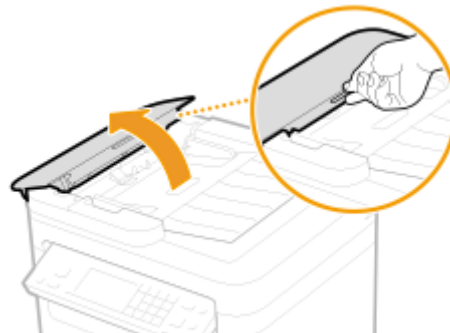

### 4 Wipe roller (a) inside feeder.

- Wipe the rollers with a cloth that has been moistened with water and wrung out. Then wipe with a dry cloth.

MF269dw

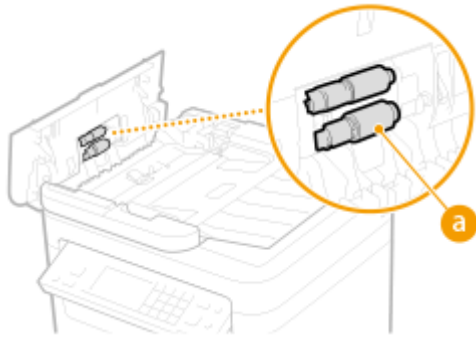

MF267dw / MF264dw

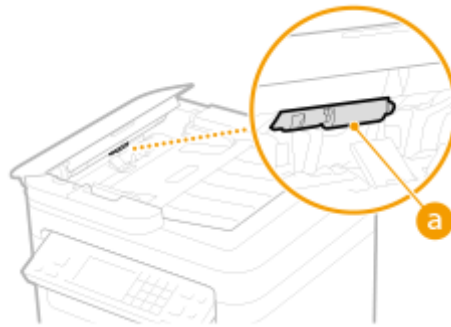

**IMPORTANT:**

- If the rollers and surrounding areas are very dirty, clean them out. To do this, wet a cloth with water and wring it out well, then wipe the dirty areas. Afterwards, wipe the areas with a soft and dry cloth.

MF269dw



MF267dw / MF264dw



**5** Close the feeder cover and original supply tray.

**6** Open the feeder.

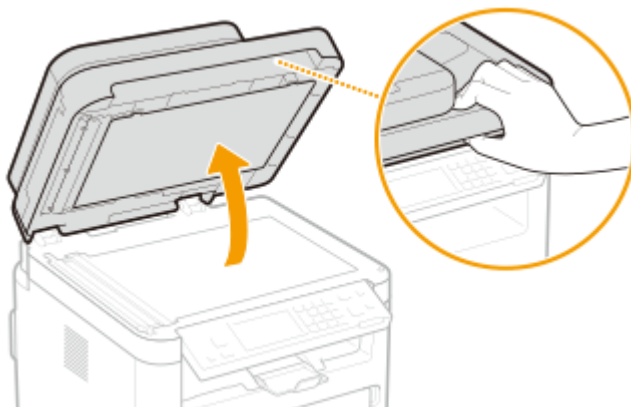

**7** Wipe the original scanning area.

- Wipe with a cloth that has been moistened with water and wrung out, and then wipe with a dry cloth.

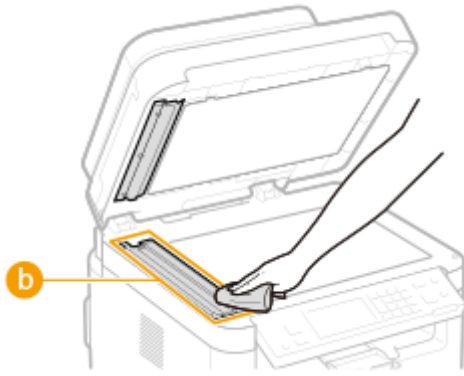

**IMPORTANT:**

- When wiping the transparent plastic part (b), take care not to bend the plastic.

**■If the problem persists**

Remove the transparent plastic part (b) and wipe it.

- 1 Hold the tabs (c) at both ends of the transparent plastic part, and remove the plastic part by gently lifting the rearward end first.

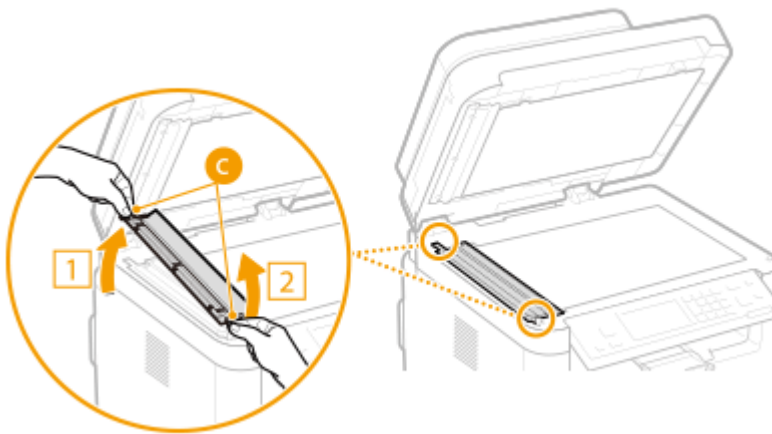

**IMPORTANT:**

- The plastic part (b) is rather damageable. When removing it, be careful not to bend it.

- 2 Wipe the original scanning area (d).

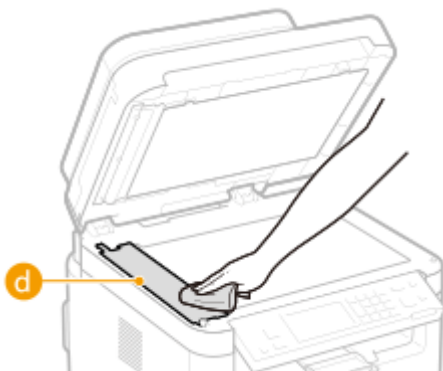

- 3 Wipe the back side of the transparent plastic part.

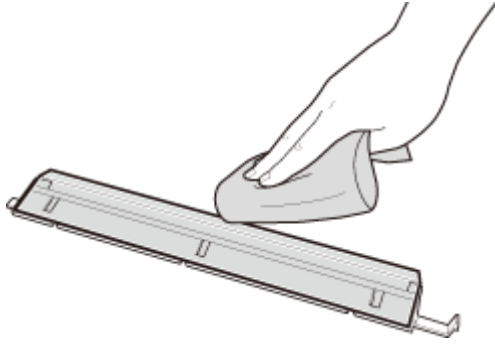

- 4** Wait for the plastic part to dry completely.
- 5** Place the transparent plastic part back into position.
  - Make sure of the proper orientation, then hold the tabs and place the plastic part back into position by gently lowering the frontward end first.
  
- 8** Wait for the cleaned area to dry completely.
  
- 9** Gently close the feeder cover.
  
- 10** Plug the machine back into the power outlet and switch it on.

# Cleaning the Fixing Assembly

2KUU-084

Dirt may adhere to the fixing assembly inside the machine and cause black streaks to appear on printouts. To clean the fixing assembly, perform the following procedure. Note that you cannot clean the fixing assembly when the machine has documents waiting to be printed. To clean the fixing assembly, you need plain A4 or Letter size paper. Set the paper in the drawer before performing the following procedure. **▶ Loading Paper(P. 132)**

## NOTE

- Cleaning consumes the toner cartridge and the drum cartridge. Make sure that there is sufficient amount remaining in the toner cartridge and the drum cartridge beforehand. **▶ Checking the Remaining Amount of Consumables(P. 451)**

### 1 Display the <Menu> screen. **▶ Home Screen(P. 111)**

#### Touch Panel Model

Select <Menu> in the Home screen.

#### 5 Lines LCD Model

Press .

### 2 Select <Adjustment/Maintenance>.

### 3 Select <Clean Fixing Assembly>.

### 4 Check that the size and type of paper displayed on the screen is loaded in the machine, and select <Start>.

▢ Cleaning starts.

# Cleaning the Machine Interior

2KUU-085

Clean the interior of the machine regularly so that toner/paper dust does not collect.

## 1 Turn off the machine and unplug it from the power outlet.

- Turning the printer OFF erases any queued print data. Data such as documents received and held in memory, documents waiting to be sent, and reports that are automatically printed after sending or receiving faxes are not deleted.

## 2 Lift the operation panel.

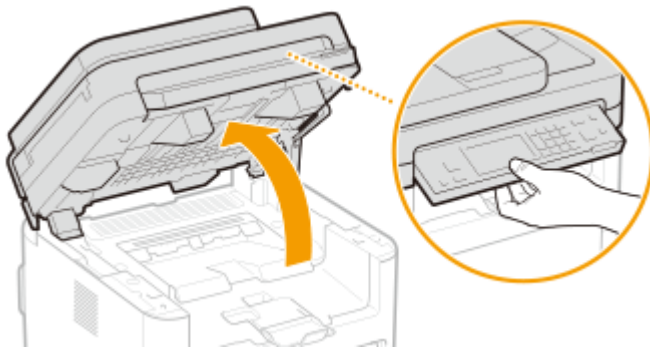

### NOTE:

#### If you cannot lift the operation panel

- Make sure the feeder is completely closed. If a thick original such as a book is placed on the platen glass, remove the original. Forcing the operation panel up may cause damage.

## 3 Open the toner cover.

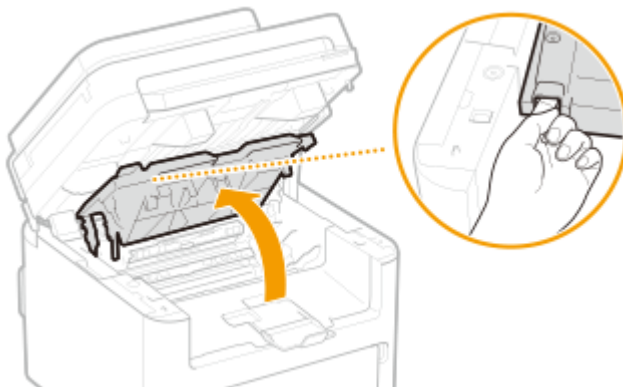

## 4 Remove the toner cartridge.

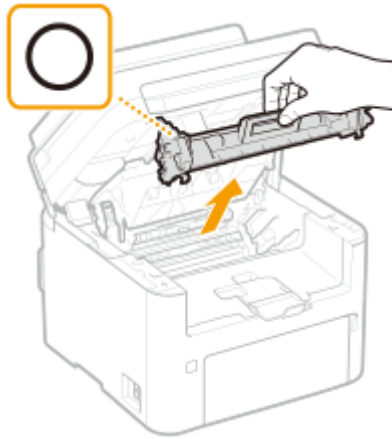

**IMPORTANT:**

- Do not shake or tilt the toner cartridge. Also, make sure to avoid applying shocks to the toner cartridge, such as by hitting it against something. Doing so may cause the toner left in the toner cartridge to leak. Remove the toner cartridge gently at the same angle as the slot.

**5 Remove the drum cartridge.**

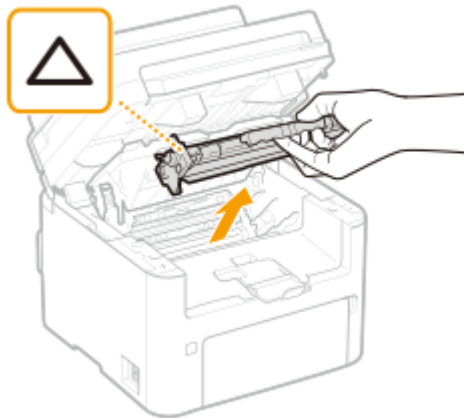

**IMPORTANT:**

- Do not shake or tilt the drum cartridge. Also, make sure to avoid applying shocks to the drum cartridge, such as by hitting it against something. Doing so may cause the toner left in the drum cartridge to leak. Remove the drum cartridge gently at the same angle as the slot.

**6 Using a lint-free clean, soft, dry cloth, wipe away toner/paper dust from the inside.**

**7 Insert the drum cartridge.**



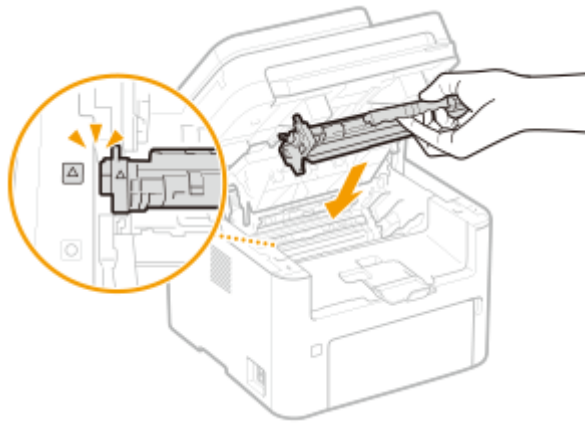

**8** Insert the toner cartridge.

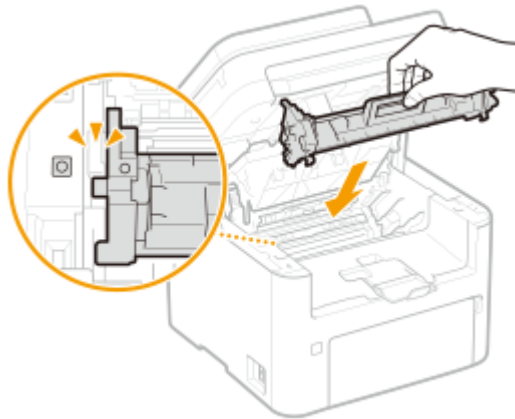

**9** Close the toner cover.

**10** Lower the operation panel.

**11** Reconnect the power cord and turn ON the machine.

# Replacing the Toner Cartridge

2KUU-086

The machine displays a message when the amount remaining in the toner cartridge is low. Note that the print quality may suffer if you continue printing without resolving this issue. You can check the amount remaining in the toner cartridge on the display ( **Checking the Remaining Amount of Consumables(P. 451)** ).

**When a Message Appear(P. 443)**

**Procedure for Replacing the Toner Cartridge(P. 444)**

## When a Message Appear

The message that is displayed depends on the amount remaining in the toner cartridge. Depending on which message is displayed, prepare a new toner cartridge ( **Consumables(P. 460)** ) or replace the current toner cartridge with a new one ( **Procedure for Replacing the Toner Cartridge(P. 444)** ).

### <Preparing a toner cartridge is recommended.>/<Preparing a toner cart. is recommended.>

This message notifies you that the toner cartridge needs to be replaced soon. Make sure that you have a replacement toner cartridge ready. Replace the toner cartridge if you see this message before you start to print a large job.

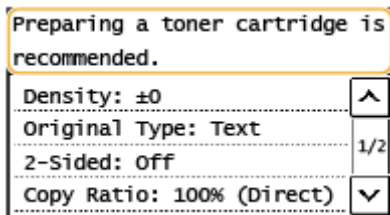

## NOTE

### When this message is displayed

- When printing, you can continue printing the original.

### Specify when this message is displayed

- You can set any value as the percentage of the amount remaining in the toner cartridge that triggers this message. **<Displ. Timing for Cartridge Prep. Notif.>(P. 415)**

### <Toner cart. end of lifetime. Replacement is recommended.>/<Toner cart. life end. Replcmt. recommended.>

This message notifies you that the toner cartridge has reached the end of its lifetime. It is recommended that you replace the toner cartridge with a new one. You can continue printing, but the print quality cannot be guaranteed.

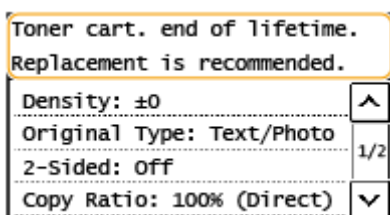

**<Status Monitor>**

 ▶ <Error Information/Notification> ▶ <Toner Cartridge End of Lifetime> to display the procedure for replacing the toner cartridge.

**NOTE****To replace a consumable**

- Press and hold . Select <Consumables Status Report>, print the consumables status report to find out the cartridge name.  **Printing Reports and Lists (P. 455)**

**Procedure for Replacing the Toner Cartridge**

When you replace the toner cartridge, simple instructions on the replacement procedure are displayed on the screen. See the on-screen instructions as well as the following procedure.

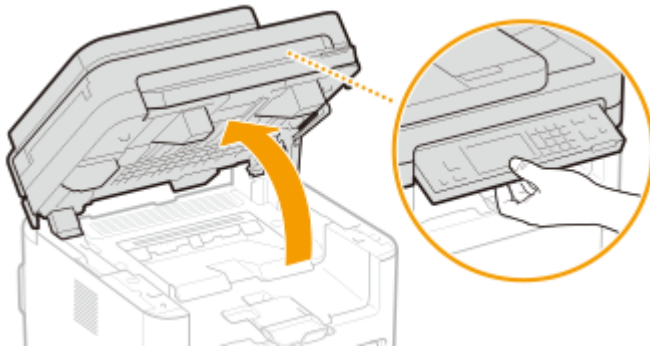
**1 Lift the operation panel.****NOTE:****If you cannot lift the operation panel**

- Make sure the feeder is completely closed. If a thick original such as a book is placed on the platen glass, remove the original. Forcing the operation panel up may cause damage.

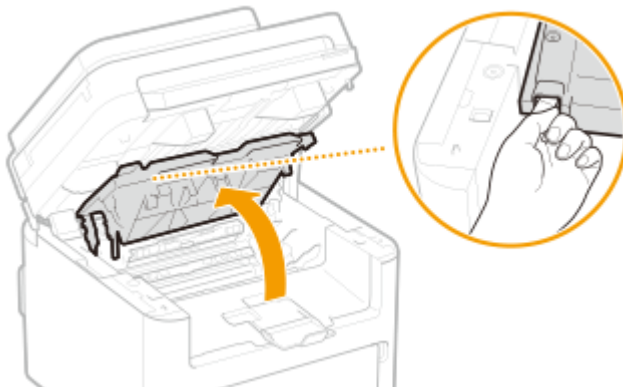
**2 Open the toner cover.****3 Remove the toner cartridge.**

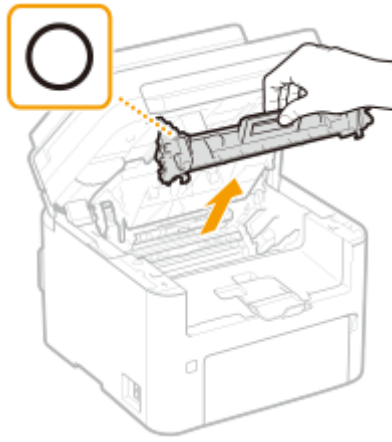

**IMPORTANT:**

- Do not shake or tilt the toner cartridge. Also, make sure to avoid applying shocks to the toner cartridge, such as by hitting it against something. Doing so may cause the toner left in the toner cartridge to leak. Remove the toner cartridge gently at the same angle as the slot.

**4 Remove the new toner cartridge from the protective package.**

- 1** Pull the tab of the protective package on a flat place.

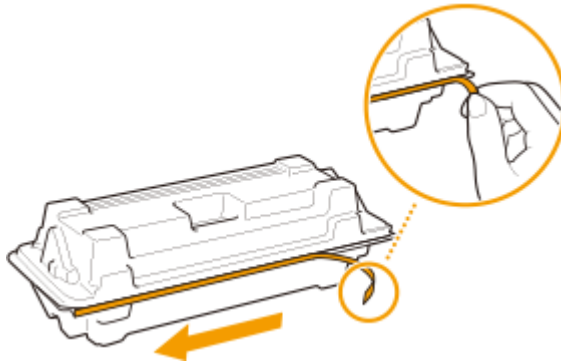

- 2** Pull out the toner cartridge.

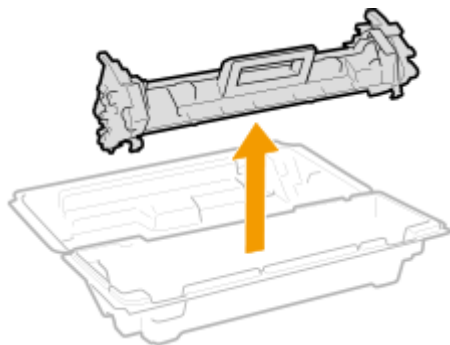

**5 Shake the toner cartridge 5 or 6 times as shown below to evenly distribute the toner inside the cartridge, and then place it on a flat surface.**

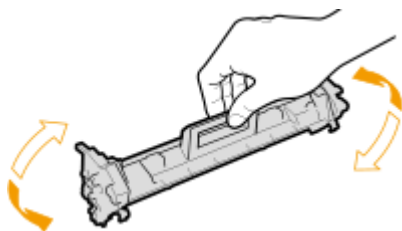

**6** Replace the toner cartridge.

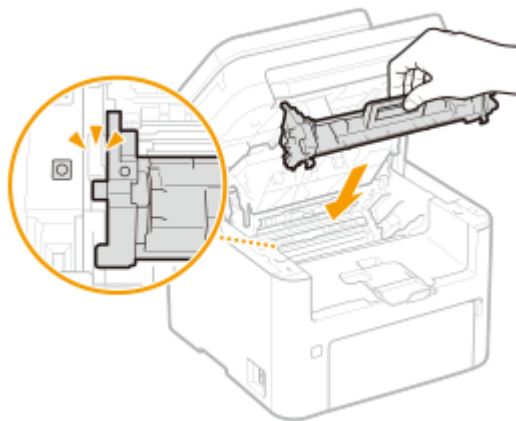

**7** Close the toner cover.

**8** Lower the operation panel.

LINKS

---

▶ Consumables(P. 460)

# Replacing the Drum Cartridge

2KUU-087

The machine displays a message when the amount remaining in the drum cartridge is low. Note that the print quality may suffer if you continue printing without resolving this issue. You can check the amount remaining in the drum cartridge on the display ( [▶Checking the Remaining Amount of Consumables\(P. 451\)](#) ).

- ▶[When a Message Appear\(P. 447\)](#)
- ▶[Procedure for Replacing the Drum Cartridge\(P. 448\)](#)

## When a Message Appear

The message that is displayed depends on the amount remaining in the drum cartridge. Depending on which message is displayed, prepare a new drum cartridge ( [▶Consumables\(P. 460\)](#) ) or replace the current drum cartridge with a new one ( [▶Procedure for Replacing the Drum Cartridge\(P. 448\)](#) ).

### <Preparing a drum cartridge is recommended.>/<Preparing a drum cart. is recommended.>

This message notifies you that the drum cartridge needs to be replaced soon. Make sure that you have a replacement drum cartridge ready. Replace the drum cartridge if you see this message before you start to print a large job.

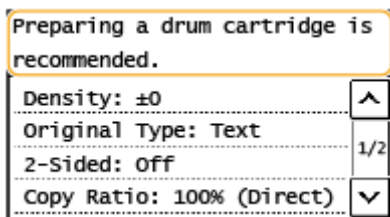

## NOTE

### When this message is displayed

- When printing, you can continue printing the original.

### Specify when this message is displayed

- You can set any value as the percentage of the amount remaining in the drum cartridge that triggers this message. [▶<Displ. Timing for Cartridge Prep. Notif.>\(P. 415\)](#)

### <Drum cart. end of lifetime. Replacement is recommended.>/<Drum cart. life end. Replcmt. recommended.>

This message notifies you that the drum cartridge has reached the end of its lifetime. It is recommended that you replace the drum cartridge with a new one. You can continue printing, but the print quality cannot be guaranteed.

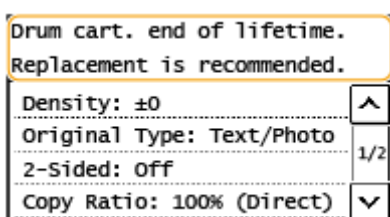

**<Status Monitor>**

 ▶ <Error Information/Notification> ▶ <Drum Cartridge End of Lifetime> to display the procedure for replacing the drum cartridge.

**NOTE****To replace a consumable**

- Press and hold . Select <Consumables Status Report>, print the consumables status report to find out the cartridge name.  **Printing Reports and Lists (P. 455)**

**Procedure for Replacing the Drum Cartridge**

When you replace the drum cartridge, simple instructions on the replacement procedure are displayed on the screen. See the on-screen instructions as well as the following procedure.

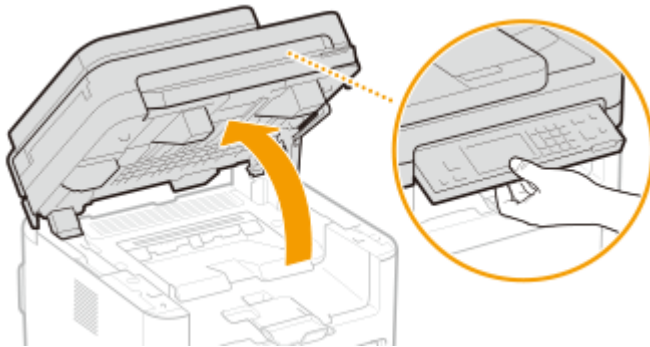
**1 Lift the operation panel.****NOTE:****If you cannot lift the operation panel**

- Make sure the feeder is completely closed. If a thick original such as a book is placed on the platen glass, remove the original. Forcing the operation panel up may cause damage.

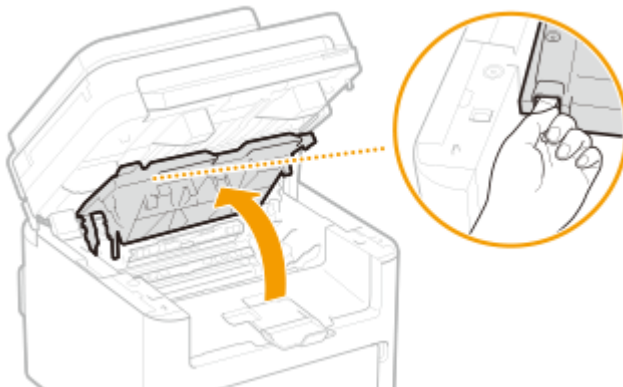
**2 Open the toner cover.****3 Remove the toner cartridge.**

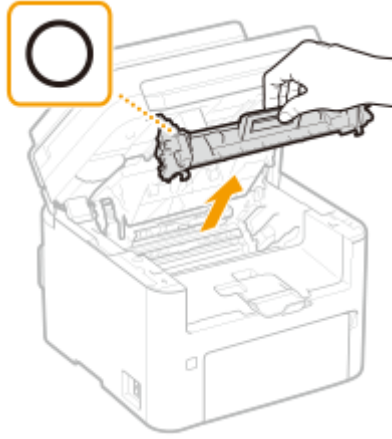
**IMPORTANT:**

Do not shake or tilt the toner cartridge. Also, make sure to avoid applying shocks to the toner cartridge, such as by hitting it against something. Doing so may cause the toner left in the toner cartridge to leak. Remove the toner cartridge gently at the same angle as the slot.

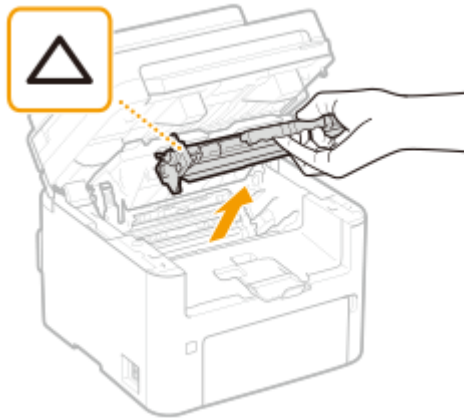
**4 Remove the drum cartridge.****IMPORTANT:**

Do not shake or tilt the drum cartridge. Also, make sure to avoid applying shocks to the drum cartridge, such as by hitting it against something. Doing so may cause the toner left in the drum cartridge to leak. Remove the drum cartridge gently at the same angle as the slot.

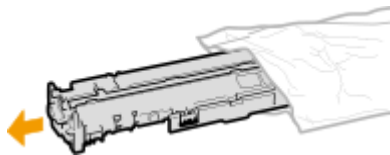
**5 Remove the new drum cartridge from the protective bag.****6 Replace the drum cartridge.**



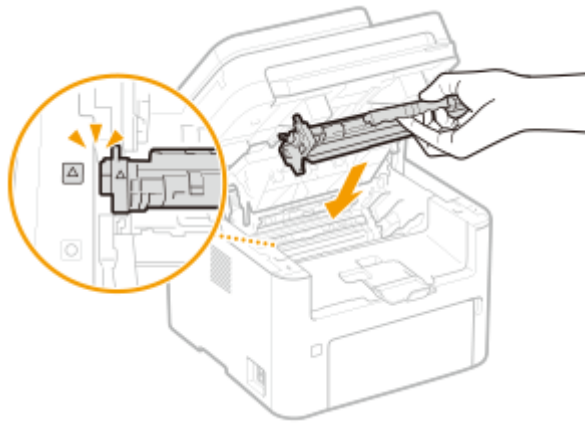

**7** Insert the toner cartridge.

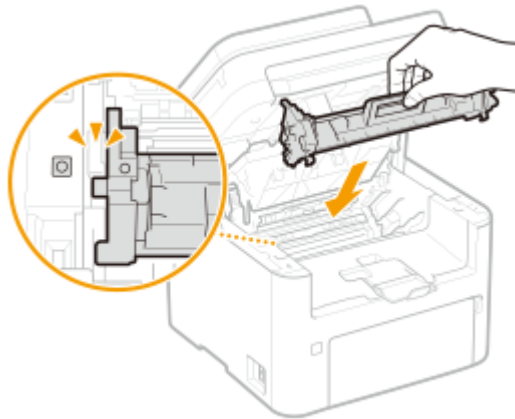

**8** Close the toner cover.

**9** Lower the operation panel.

LINKS

---

▶ Consumables(P. 460)

## Checking the Remaining Amount of Consumables

2KUU-088

Use the procedure below to check the amount remaining in the toner cartridge, etc. It is particularly important to check whether you need to have a new toner cartridge or a new drum cartridge ready before starting a large print job.

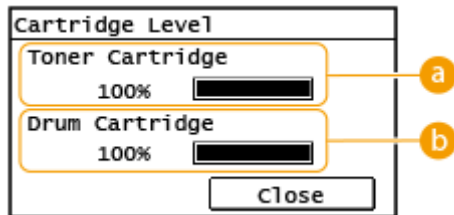

### **a** Amount Remaining in Toner Cartridge

Displays the amount remaining in the toner cartridge.

### **b** Amount Remaining in Drum Cartridge

Displays the amount remaining in the drum cartridge.

## NOTE

- The displayed amount remaining in the toner cartridge or the drum cartridge can be used only as a guide and may differ from the actual amount.
- Other internal parts may reach the end of their lifetime before the amount remaining in the toner cartridge or the drum cartridge reaches its lifetime.

## LINKS

- ▶ [Replacing the Toner Cartridge\(P. 443\)](#)
- ▶ [Replacing the Drum Cartridge\(P. 447\)](#)
- ▶ [Consumables\(P. 460\)](#)

# Relocating the Machine

2KUU-089

The machine is heavy. Make sure to follow the procedure below when moving the machine to avoid injury.

## 1 Turn OFF the machine and computer.

- Turning the printer OFF erases any queued print data. Data such as documents received and held in memory, documents waiting to be sent, and reports that are automatically printed after sending or receiving faxes are not deleted.

## 2 Disconnect the cables and cord from the machine in numerical order as in the illustration below.

- Whether the cables with "\*" are connected depends on your environment.

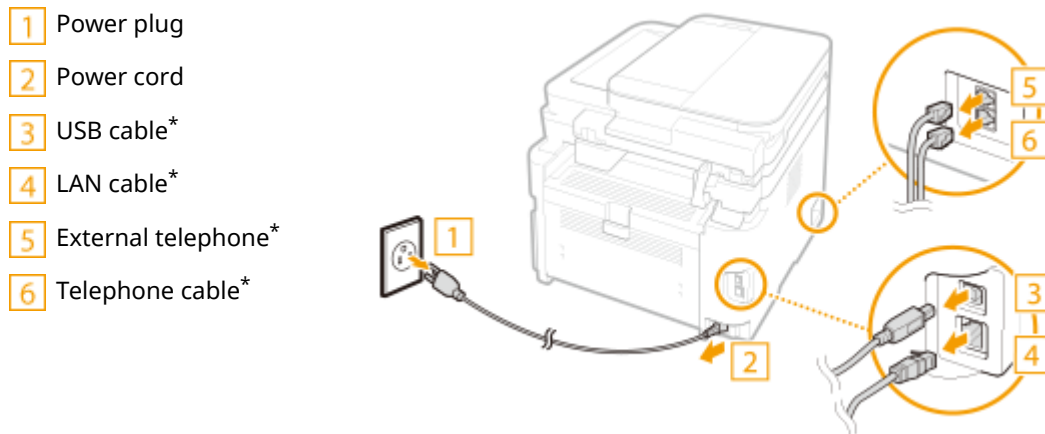

## 3 When transporting the machine across a long distance, remove the toner cartridge and the drum cartridge.

- ▶ Procedure for Replacing the Toner Cartridge(P. 444)
- ▶ Procedure for Replacing the Drum Cartridge(P. 448)

## 4 Open the front cover and remove any paper.

- If the paper guides are extended, return them so that they fit in the drawer.



## 5 Close the front cover, paper stopper, and all similar parts, and then move the machine to a new location.

- Check how heavy the machine is and carry it without straining. ▶ Main Unit(P. 533)

- Hold the lift handles, and lift up the machine.

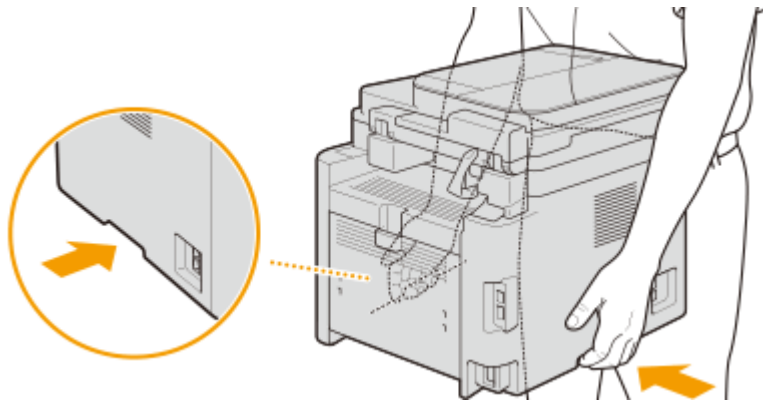

## 6 Carefully place the machine at the new installation site.

- For information about how to install the machine after relocating it, see "Getting Started." [▶ Manuals and Their Contents\(P. 549\)](#)

## Viewing the Counter Value

---

2KUU-08A

You can check total for the number of pages used for printouts. The number of printouts includes printouts of the list as well as printouts of data from computers.

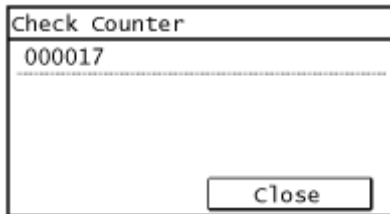
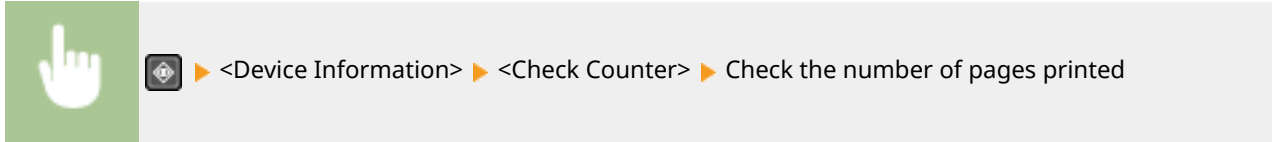

# Printing Reports and Lists

2KUU-08C

You can print reports and lists to check information such as machine settings.

- ▶ **Setting Reports on the Communication Results(P. 455)**
- ▶ **Printing Lists of Settings(P. 456)**
- ▶ **Printing Reports and Lists on the Usage Status of the Machine(P. 457)**

## Setting Reports on the Communication Results

You can print reports on the results of sending by e-mail and sending/receiving by fax, as well as results of saving to a shared folder. Some reports can be printed automatically while others are only printed when an error occurs.

### NOTE

- If "Result" in a printed list contains "NG," you can check details of the error from a three-digit number prefixed with "#" displayed in the next to the result. ▶ **Countermeasures for Each Error Code(P. 504)**
- Reports printed for e-mail indicate the transmission result between the machine and the mail server, not between the machine and the destination address.

### Communication Management Report (Touch Panel Model)

You can check the fax and e-mail logs of sent and received documents by printing a Communication Management Report. The report can be printed automatically after every 40 transmissions, or you can print it manually.



<Menu> ▶ <Output Rprt.> ▶ <Report Settings> ▶ <Communication Management Report> ▶ Configure report settings

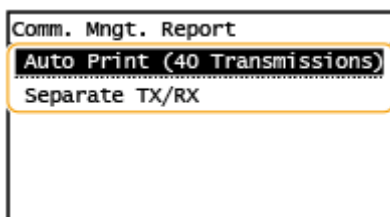

#### <Auto Print (40 Transmissions)>

Select <On> to print the report automatically after every 40 transmissions, or <Off> if you do not want to print the report automatically.

#### <Separate TX/RX>

Select <On> to print sent and received reports separately, or <Off> to print both reports on one sheet.

#### ■ Print the report manually



<Menu> ▶ <Output Rprt.> ▶ <Print List> ▶ <Communication Management Report> ▶ Check that the size and type of paper displayed on the screen is loaded in the machine, and select <OK> ▶ <Yes>

### Fax TX Result Report (Touch Panel Model)

You can check the fax logs of sent documents by printing a Fax TX Result Report. The report can be printed either every time a transmission is completed or only when a sending error occurs.



<Menu> ▶ <Output Rprt.> ▶ <Report Settings> ▶ <Fax TX Result Report> ▶ Select <On> or <Only When Error Occurs> ▶ Select <Off> or <On>

### E-Mail/File TX Result Report (Touch Panel Model)

You can check the e-mail logs of sent documents as well as documents saved to a shared folder by printing an E-Mail/File TX Result Report. The report can be printed either every time a transmission is completed or only when a sending error occurs.



<Menu> ▶ <Output Rprt.> ▶ <Report Settings> ▶ <E-Mail/File TX Result Report> ▶ Select <On> or <Only When Error Occurs>

## NOTE

### Communication result

- If an error occurs during transmission by e-mail or saving to a shared folder, the report does not show the error code. To check the error code, print a Communication Management Report. ▶ **Communication Management Report (Touch Panel Model)(P. 455)**

### RX Result Report (Touch Panel Model)

You can check the logs of received fax documents by printing an RX Result Report. The report can be printed either every time a transmission is completed or only when a receiving error occurs.



<Menu> ▶ <Output Rprt.> ▶ <Report Settings> ▶ <RX Result Report> ▶ Select <On> or <Only When Error Occurs>

## Printing Lists of Settings

You can print information and settings registered in the machine as a list.

## Address Book List (Touch Panel Model)

You can check the list of destinations registered in the Address Book as <Coded Dial>, <One-Touch>, and <Group> by printing an Address Book List.



<Menu> ▶ <Output Rprt.> ▶ <Print List> ▶ <Address Book List> ▶ Select the setting you want to print out ▶ Check that the size and type of paper displayed on the screen is loaded in the machine, and select <OK> ▶ <Yes>

## User Data List

You can check the list of the settings (  **Setting Menu List(P. 361)** ) as well as the content that has been registered in the machine by printing a User Data List. The list include the firmware version and the paper size and type registered in the machine.

### Touch Panel Model



<Menu> ▶ <Output Rprt.> ▶ <Print List> ▶ <User Data List> ▶ Check that the size and type of paper displayed on the screen is loaded in the machine, and select <OK> ▶ <Yes>

### 5 Lines LCD Model



 ▶ <Output Report> ▶ <User Data List> ▶ Check that the size and type of paper displayed on the screen is loaded in the machine, and select <OK> ▶ <Yes>

## Printing Reports and Lists on the Usage Status of the Machine

You can print the machine status report, the usage log of consumables, and the list of fonts available in PCL mode.

### Eco Report

You can check the monthly total volume of printouts and the power consumption with a report. This report includes tips that are useful for saving paper and power consumption based on the usage status.

### Touch Panel Model



<Menu> ▶ <Output Rprt.> ▶ <Print List> ▶ <Eco Report> ▶ Check that the size and type of paper displayed on the screen is loaded in the machine, and select <OK> ▶ <Yes>

### 5 Lines LCD Model





 ▶ <Output Report> ▶ <Eco Report> ▶ Check that the size and type of paper displayed on the screen is loaded in the machine, and select <OK> ▶ <Yes>

## Consumables Status Report

You can check the consumables status installed in the machine with a report.

### Touch Panel Model



<Menu> ▶ <Output Rprt.> ▶ <Print List> ▶ <Consumables Status Report> ▶ Check that the size and type of paper displayed on the screen is loaded in the machine, and select <OK> ▶ <Yes>

### 5 Lines LCD Model



 ▶ <Output Report> ▶ <Consumables Status Report> ▶ Check that the size and type of paper displayed on the screen is loaded in the machine, and select <OK> ▶ <Yes>

## PCL Font List

You can check the list of fonts available in PCL mode with a report.

### Touch Panel Model



<Menu> ▶ <Output Rprt.> ▶ <Print List> ▶ <PCL Font List> ▶ Check that the size and type of paper displayed on the screen is loaded in the machine, and select <OK> ▶ <Yes>

### 5 Lines LCD Model



 ▶ <Output Report> ▶ <PCL Font List> ▶ Check that the size and type of paper displayed on the screen is loaded in the machine, and select <OK> ▶ <Yes>

## Cartridge Log Report

You can check the usage logs of toner cartridge and the drum cartridge with a report.

### Touch Panel Model



<Menu> ▶ <Output Rprt.> ▶ <Print List> ▶ <Cartridge Log Report> ▶ Check that the size and type of paper displayed on the screen is loaded in the machine, and select <OK> ▶ <Yes>

### 5 Lines LCD Model



▶ <Output Report> ▶ <Cartridge Log Report> ▶ Check that the size and type of paper displayed on the screen is loaded in the machine, and press **OK** ▶ <Yes>

# Consumables

2KUU-08E

The following is a guide to the estimated replacement time for the consumables used in this machine. Purchase consumables at your local authorized Canon dealer. Observe safety and health precautions when storing and handling consumables. For optimum print quality, using Canon genuine Toner, Cartridge and Parts is recommended.



## NOTE

- To handle and store consumables, observe precautions in "Getting Started" provided for this product.
- Depending on the installation environment, printing paper size, or original type, you may need to replace consumables before the end of the estimated lifetime.

### ■ Toner Cartridges

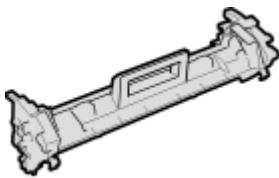

#### Supplied Toner Cartridge

The average yield and the weight of the toner cartridge that comes with the machine are shown below.

- Average yield\*  
1,700 sheets
- Weight  
Approx. 0.3 Kg

#### Replacement Toner Cartridges

For optimum print quality, using Canon genuine toner cartridges is recommended.

Canon Genuine Toner Cartridge	Average yield and weight of toner cartridge
Canon Toner Cartridge 051	<ul style="list-style-type: none"> <li>• Average yield* 1,700 sheets</li> <li>• Weight Approx. 0.3 Kg</li> </ul>
Canon Toner Cartridge 051H	<ul style="list-style-type: none"> <li>• Average yield* 4,100 sheets</li> <li>• Weight Approx. 0.4 Kg</li> </ul>

\*The average yield is based on "ISO/IEC 19752" (the global standard related to "Method for the determination of toner cartridge yield for monochromatic electrophotographic printers and multi-function devices that contain printer components" issued by ISO [International Organization for Standardization]) when printing A4 size paper with the default print density setting.

## IMPORTANT

### Be careful of counterfeit toner cartridges

- Please be aware that there are counterfeit Canon toner cartridges in the marketplace. Use of counterfeit toner cartridge may result in poor print quality or machine performance. Canon is not responsible for any malfunction, accident or damage caused by the use of counterfeit toner cartridge. For more information, see [canon.com/counterfeit](http://canon.com/counterfeit).

## NOTE

- When replacing toner cartridge, see [▶ Replacing the Toner Cartridge \(P. 443\)](#).

### ■ Drum Cartridge

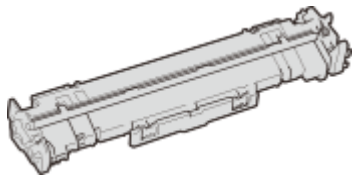

#### Supplied Drum Cartridge

The average yield and the weight of the drum cartridge that comes with the machine are shown below.

- Average yield\*  
23,000 sheets
- Weight  
Approx. 0.2 Kg

#### Replacement Drum Cartridges

For optimum print quality, using Canon genuine drum cartridges is recommended.

Canon Genuine Drum Cartridge	Average yield and weight of drum cartridge
Canon Drum Cartridge 051	<ul style="list-style-type: none"> <li>• Average yield* 23,000 sheets</li> <li>• Weight Approx. 0.2 Kg</li> </ul>

\*The average yield is on the basis of our evaluation criteria when printing at 2-sheet intervals (2-sheet intermittent) of plain A4 size paper.

## IMPORTANT

### Be careful of counterfeit drum cartridges

- Please be aware that there are counterfeit Canon drum cartridges in the marketplace. Use of counterfeit drum cartridge may result in poor print quality or machine performance. Canon is not responsible for any malfunction, accident or damage caused by the use of counterfeit drum cartridge. For more information, see [canon.com/counterfeit](http://canon.com/counterfeit).

## NOTE

- When replacing drum cartridge, see [▶ Replacing the Drum Cartridge\(P. 447\)](#) .

# Troubleshooting

<b>Troubleshooting</b> .....	464
<b>Common Problems</b> .....	466
Installation/Settings Problems .....	467
Copying/Printing Problems .....	471
Faxing/Telephone Problems .....	474
<b>When You Cannot Print Properly</b> .....	476
Printing Results Are Not Satisfactory .....	478
Paper Creases or Curls .....	487
Paper Is Fed Incorrectly .....	489
<b>A Message or a Number Starting with "#" (an Error Code) Is Displayed</b> .....	490
Countermeasures for Each Message .....	491
Countermeasures for Each Error Code .....	504
<b>Clearing Paper Jams</b> .....	510
Paper Jams in the Feeder .....	511
Paper Jams inside the Machine .....	514
<b>When a Problem Cannot Be Solved</b> .....	518

# Troubleshooting

---

2KUU-08F

When a problem occurs, check this chapter to find out solutions before contacting Canon.

## ■ Common Problems

This section describes how to take action when you suspect that the machine is malfunctioning. ▶ **Common Problems(P. 466)**



## ■ When You Cannot Print Properly

This section describes how to take action when printing results are not satisfactory or the paper creases or curls. ▶ **When You Cannot Print Properly(P. 476)**



## ■ A Message or a Number Starting with "#" (an Error Code) is Displayed

This section describes how to take action when a message or error code (three digits) appears on the display. ▶ **A Message or a Number Starting with "#" (an Error Code) Is Displayed(P. 490)**



## ■ Clearing Paper Jams

This section describes how to take action when a paper is jammed. ▶ **Clearing Paper Jams(P. 510)**



## ■ When a Problem Cannot Be Solved

If a problem persists, see ▶ **When a Problem Cannot Be Solved(P. 518)** to find out where to contact.

## Troubleshooting





## Common Problems

---

2KUU-08H

If you encounter problems when using the machine, check the items in this section before contacting us. If the problems persist, contact your local authorized Canon dealer or the Canon help line.

### Check the Following

#### → Is the machine turned ON? Is the power cord connected?

- If the machine is turned ON but does not respond, turn it OFF, check whether the power cord is connected correctly, and turn it back ON. For information on connecting the power cord, see Getting Started. ▶ **Manuals and Their Contents(P. 549)**

#### → Are the phone cord, LAN cable and USB cable connected correctly?

- Check whether these cables are connected correctly. Use care not to mistake the phone cord's port for the other cables' ports.
  - ▶ **Connecting the Telephone Line(P. 74)**
  - ▶ **Parts and Their Functions(P. 94)**

#### → Is sleep mode activated?

- If you leave the machine unattended for a specific period of time, it enters sleep mode for power conservation, not allowing you to operate it.  
To cancel sleep mode, press any key other than the power switch.

#### → Is any message displayed on the screen?

- If a problem occurs, a message is displayed. ▶ **Countermeasures for Each Message(P. 491)**

#### If a problem persists even after checking

---

Click the link that corresponds to the problem.

- ▶ **Installation/Settings Problems(P. 467)**
- ▶ **Copying/Printing Problems(P. 471)**
- ▶ **Faxing/Telephone Problems(P. 474)**

## Installation/Settings Problems

2KUU-08J

See [▶Common Problems\(P. 466\)](#) also.

- ▶[Problems with the Wireless/Wired LAN Connection\(P. 467\)](#)
- ▶[Problem with the USB Connection\(P. 470\)](#)
- ▶[Problem with the Print Server\(P. 470\)](#)

### Problems with the Wireless/Wired LAN Connection

#### The wireless LAN and wired LAN cannot be connected at the same time.

- The wireless LAN and wired LAN cannot be connected at the same time. The following can be used at the same time: a USB cable and a wireless LAN, or a USB cable and a wired LAN.

#### Remote UI is not displayed.

- Are <Use HTTP> and <Use Remote UI> set to <On>?
  - ▶[Disabling HTTP Communication\(P. 332\)](#)
  - ▶[Disabling Remote UI\(P. 333\)](#)
- If the machine is connected to a wireless LAN on a touch panel model, check that the Wi-Fi icon is displayed in the Home screen and that the IP address is set correctly, and then start the Remote UI again.
  - ▶[Home Screen\(P. 111\)](#)
  - ▶[Viewing Network Settings\(P. 38\)](#)
- If the machine is connected to a wired LAN, check that the cable is connected firmly and the IP address is set correctly, and then start the Remote UI again.
  - ▶[Connecting to a Wired LAN\(P. 17\)](#)
  - ▶[Viewing Network Settings\(P. 38\)](#)
- Are you using a proxy server? If so, add the machine's IP address to the [Exceptions] list (addresses that do not use the proxy server) in the Web browser's proxy settings dialog.
- Is communication not limited by the firewall on your computer? If IP addresses are or an MAC address is incorrectly entered, the Remote UI cannot be displayed. In that case, you need to use the operation panel to set <IPv4 Address Filter>, <IPv6 Address Filter>, or <MAC Address Filter> to <Off>.
  - ▶[Restricting Communication by Using Firewalls\(P. 299\)](#)
  - ▶[<IPv4 Address Filter>\(P. 422\)](#)
  - ▶[<IPv6 Address Filter>\(P. 422\)](#)
  - ▶[<MAC Address Filter>\(P. 423\)](#)

#### A connection to a network cannot be established.

- The IP address may not be set correctly. Set the IP address again.
  - ▶[Setting IP Addresses\(P. 31\)](#)
- When you connect the machine to a computer via wireless LAN, check whether the machine is properly installed and ready to connect to the network.
  - ▶[When the Machine Cannot Connect to the Wireless LAN\(P. 468\)](#)

## You are unsure of the set IP address. ▶ Viewing Network Settings(P. 38)

### The connection method cannot be switched between a wired LAN and a wireless LAN.

- Did you select a wired LAN or a wireless LAN on the operation panel on the machine as well? This selection is required to have the machine switch to your selection.
  - ▶ **Selecting Wired LAN or Wireless LAN(P. 16)**

### You are unsure of the SSID or the network key of the wireless router to be connected. The SSID is not displayed on the screen.

- Check whether the SSID can be found on the wireless router or package box.
- Check the SSID or the network key of the wireless router by using Canon MF/LBP Wireless Setup Assistant.
  - ▶ **Checking the SSID and Network Key(P. 30)**

### The SSID of the wireless router to be connected is not displayed in the access point list.

- Check whether the SSID is correct.
  - ▶ **Checking the SSID and Network Key(P. 30)**
- If the SSID of the wireless router is hidden (using a stealth mode\*), set the SSID to be visible on the wireless router.

\* A mode that disables the SSID auto-detection of other devices.

- Check whether the machine is properly installed and ready to connect to the network.
  - ▶ **When the Machine Cannot Connect to the Wireless LAN(P. 468)**

### The machine dials up to an unintended connection destination (if a dialup router is connected to a network).

- If a dialup router does not need to pass broadcast packets, set the dialup router so that the broadcast packets will not pass. If the dialup router needs to pass broadcast packets, check whether the settings are correct.
- If a DNS server is located in an external network, set the IP address to be connected, not the host name, even if connecting to the devices that are on the network that is connected to the machine.
- If a DNS server is located on a network that is connected to the machine and the information about the devices that are connected to an external network is registered to the DNS server, check whether the settings are correct.

## When the Machine Cannot Connect to the Wireless LAN



### 1 Check the status of your computer.

- Have the settings of the computer and the wireless router been completed?
- Are the cables of the wireless router (including the power cord and LAN cable) correctly plugged in?
- Is the wireless router turned on?

**If the problem persists even after checking the above:**

- Turn off the devices, and then turn them on again.
- Wait for a while, and try again to connect to the network.



**Check whether the machine is turned ON.**

- If the machine is turned ON, turn it OFF, and then turn it back ON.



**Check the installation site of the machine and the wireless router.**

- Is the machine too far from the wireless router?
- Are there any obstacles such as walls between the machine and the wireless router?
- Are there any appliances such as microwave ovens or digital cordless phones that emit radio waves near the machine?

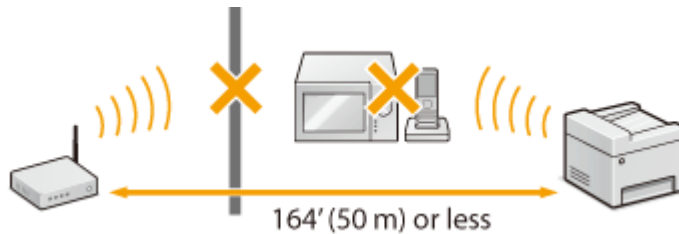

**Perform one of the following settings again.**

- ▶ **Setting Up Connection Using WPS Push Button Mode(P. 20)**
- ▶ **Setting Up Connection Using WPS PIN Code Mode(P. 22)**
- ▶ **Setting Up Connection by Selecting a Wireless Router(P. 24)**
- ▶ **Setting Up Connection by Specifying Detailed Settings(P. 27)**

**NOTE**

**When you need to manually set up the connection**

If the wireless router is set as described below, manually enter all the required information for the wireless LAN connection ( ▶ **Setting Up Connection by Specifying Detailed Settings(P. 27)** ).

- ANY connection refusal\* is activated.
- The WEP key that was automatically generated (hexadecimal) is selected.
- The stealth mode is activated.

\* A function in which the wireless router refuses the connection if the SSID on the device to be connected is set to "ANY" or is blank.

**When you need to change the settings of the wireless router**

If the wireless router is set as described below, change the settings of the router.

- The MAC address packet filtering is set.

- When only IEEE 802.11n is used for the wireless communication, WEP is selected or the WPA/WPA2 encryption method is set to TKIP.

## Problem with the USB Connection

### Cannot communicate.

- Change the USB cable. If you are using a long USB cable, replace it with a short one.
- If you are using a USB hub, connect the machine directly to your computer using a USB cable.

## Problem with the Print Server

### You cannot find the print server to connect to.

- Are the print server and computer connected correctly?
- Is the print server running?
- Do you have user rights to connect to the print server? If you are not sure, contact the server administrator.
- Is [Network discovery] enabled?
  - ▶ **Enabling [Network discovery](P. 556)**

### You cannot connect to a shared printer.

- On the network, does the machine appear among the printers of the print server? If it is not displayed, contact the network or server administrator.
  - ▶ **Displaying Shared Printers in the Print Server(P. 557)**

## Copying/Printing Problems

2KUU-08K

See [▶Common Problems\(P. 466\)](#) also.

### Printing/copy results are not satisfactory. Paper creases or curls. [▶When You Cannot Print Properly\(P. 476\)](#)

#### You cannot print.

- Can you print a Windows test page? If you can print a Windows test page, there is no problem with the machine or the printer driver. Check the print settings of your application.

#### [▶Printing a Test Page in Windows\(P. 558\)](#)

If you cannot print a test page, check the following according to your environment.

#### ■ Wireless LAN connection

- Check the connection status (signal strength) of the wireless LAN.

#### [▶Viewing Network Settings\(P. 38\)](#)

### NOTE:

- If the connection is poor, try the following.
  - Change the channel of your wireless LAN router. If you have more than one router, set the channels to be at least five channels apart.
  - If you can change the radio output power of your wireless LAN router, raise the output power.
- If your computer is connected to a wireless LAN, are the computer and this machine using the same wireless LAN router SSID? If they are different, reset the wireless LAN connection settings of this machine.
  - [▶Viewing Network Settings\(P. 38\)](#)
  - [▶Checking the SSID to Which Your Computer is Connected\(P. 563\)](#)
  - [▶Connecting to a Wireless LAN\(P. 18\)](#)

### NOTE:

#### When you reset wireless LAN connection settings

- As the wireless LAN router, select the one with the SSID to which the computer is connected.
  - Have you selected the correct port? If there is no port to use, create a port.
    - [▶Checking the Printer Port\(P. 561\)](#)
    - [▶Configuring Printer Ports\(P. 45\)](#)
  - Is communication not limited by the firewall on your computer? If IP addresses are incorrectly entered, you will be not able to access the machine. In that case, you need to use the operation panel to set <IPv4 Address Filter>, <IPv6 Address Filter>, or <MAC Address Filter> to <Off>.
    - [▶Restricting Communication by Using Firewalls\(P. 299\)](#)
    - [▶<IPv4 Address Filter> \(P. 422\)](#)
    - [▶<IPv6 Address Filter> \(P. 422\)](#)
    - [▶<MAC Address Filter> \(P. 423\)](#)
  - Disable security software and other resident software.
  - Reinstall the printer driver.
    - [▶Installing Drivers\(P. 69\)](#)

- Can you print from other computers on the network? If you also cannot print from other computers, contact your local authorized Canon dealer or the Canon help line.

■ **Wired LAN connection**

- Have you selected the correct port? If there is no port to use, create a port.
  - ▶ **Checking the Printer Port(P. 561)**
  - ▶ **Configuring Printer Ports(P. 45)**
- Is communication not limited by the firewall on your computer? If IP addresses are or an MAC address is incorrectly entered, you will be not able to access the machine. In that case, you need to use the operation panel to set <IPv4 Address Filter>, <IPv6 Address Filter>, or <MAC Address Filter> to <Off>.
  - ▶ **Restricting Communication by Using Firewalls(P. 299)**
  - ▶ **<IPv4 Address Filter> (P. 422)**
  - ▶ **<IPv6 Address Filter> (P. 422)**
  - ▶ **<MAC Address Filter> (P. 423)**
- Disable security software and other resident software.
- Reinstall the printer driver.
  - ▶ **Installing Drivers(P. 69)**
- Can you print from other computers on the network? If you also cannot print from other computers, contact your local authorized Canon dealer or the Canon help line.

■ **USB connection**

- Have you selected the correct port? If there is no port to use or you are not sure, reinstall the printer driver. When you reinstall the printer driver, the correct port is created automatically.
  - ▶ **Checking the Printer Port(P. 561)**
  - ▶ **Installing Drivers(P. 69)**
- Is bidirectional communication enabled? Enable bidirectional communication, and restart the computer.
  - ▶ **Checking Bidirectional Communication(P. 562)**
- Disable security software and other resident software.
- Connect to another USB port on the computer.
- Can you print from a USB connection to another computer? If you also cannot print from other computers, contact your local authorized Canon dealer or the Canon help line.

■ **Via print server**

- Can you print from the print server? If you can print from the print server, check the connection between the print server and your computer.
  - ▶ **Problem with the Print Server(P. 470)**
- Disable security software and other resident software.
- Reinstall the printer driver.
  - ▶ **Installing Drivers(P. 69)**
- Can you print from other computers via the print server? If you also cannot print from other computers, contact your local authorized Canon dealer or the Canon help line.

- Has an error occurred? Check the job log.
  - ▶ **Checking the Copying Status and Log(P. 179)**
  - ▶ **Checking the Printing Status and Log(P. 228)**

**Printing seems to be slow. \***

- Print or delete data in memory.

\* When the free space in memory is running low, the processing speed of the machine becomes slow, just as a computer does. There is nothing abnormal.

### **You cannot print with Google Cloud Print. Using Google Cloud Print(P. 286)**

#### **It takes a long time before printing starts.**

- Did you print to narrow width paper? After you print to narrow width paper, the machine may cool itself to maintain the print quality. As a result, it may take some time before the next job is printed. Wait until the machine is ready to print. Printing will resume when the temperature inside the machine has fallen.



# Faxing/Telephone Problems

2KUU-08L

See **Common Problems(P. 466)** also.

**Sending Problems(P. 474)**

**Receiving Problems(P. 475)**

## Sending Problems

### A fax cannot be sent.

- Is an external phone line busy? Wait until the line becomes free.
- Has an error occurred? Print and check a Communication Management Report.
  - ▶ **Communication Management Report (Touch Panel Model)(P. 455)**
- Is a telephone line set correctly?
  - ▶ **Connecting the Telephone Line(P. 74)**
- When sending the fax overseas, insert pauses in the fax number.
  - ▶ **Basic Operations for Sending Faxes(P. 195)**

### A fax cannot be sent with a destination in the history specified.

- Did you turn OFF the machine? If so, the stored history was deleted.
- Did you set <Restrict New Destinations> to <On>? If so, the history before you set was deleted.
- Did you set <Restrict Resending from Log> to <On>? If so, the destinations in the history cannot be specified.

### A fax cannot be sent on an optical fiber line.

- The machine is compliant with use on analog lines. When using an optical fiber line or IP phone line, the machine may not work correctly depending on the connection environment or connected devices. In such a case, contact the provider of the optical fiber line or IP phone.

### The results of a sent fax are not satisfactory.

- Clean the platen glass or feeder. If cleaning does not improve the results, the recipient's fax machine may be a cause.
  - ▶ **Cleaning the Platen Glass(P. 434)**
  - ▶ **Cleaning the Feeder(P. 435)**

## Receiving Problems

**The results of received fax are not satisfactory. Paper creases or curls. ▶When You Cannot Print Properly(P. 476)**

### Telephone and fax cannot be switched automatically.

- Check that the receive mode is set to <Fax/Tel (Auto Switch)>, <Answering Machine>, or <DRPD: Select Fax>.
  - ▶**Selecting the Receive Mode(P. 73)**
- Free space in memory may be running low. Print or delete data in memory.
  - ▶**Checking/Forwarding/Deleting Documents in Memory(P. 214)**
  - ▶**Printing Documents in Memory(P. 213)**

### A fax cannot be received automatically.

- Check that the receive mode is set to <Fax/Tel (Auto Switch)>, <Auto>, <Answering Machine>, or <DRPD: Select Fax>.
  - ▶**Selecting the Receive Mode(P. 73)**
- Free space in memory may be running low. Print or delete data in memory.
  - ▶**Checking/Forwarding/Deleting Documents in Memory(P. 214)**
  - ▶**Printing Documents in Memory(P. 213)**

### A fax cannot be received on an optical fiber line.

- The machine is compliant with use on analog lines. When using an optical fiber line or IP phone line, the machine may not work correctly depending on the connection environment or connected devices. In such a case, contact the provider of the optical fiber line or IP phone.

## When You Cannot Print Properly

2KUU-08R

If printing results are not satisfactory, or paper creases or curls, try the following solutions. If the problems persist, contact your local authorized Canon dealer or the Canon help line.

### ■ Problems with Image Quality ▶ Printing Results Are Not Satisfactory(P. 478)

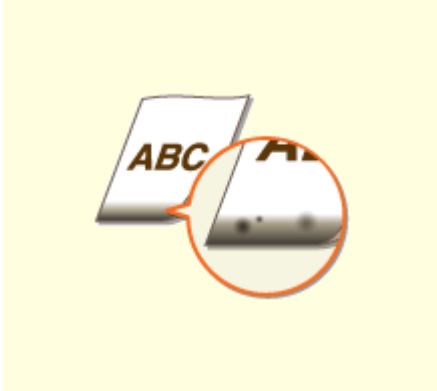

▶ Smudge Marks Appear on the Edge of Printouts(P. 478)



▶ Smudges Appear on Printouts(P. 478)



▶ Afterimages Appear in Blank Areas(P. 479)



▶ Toner Smudges and Splatters Appear(P. 479)



▶ Printouts Are Faded(P. 480)

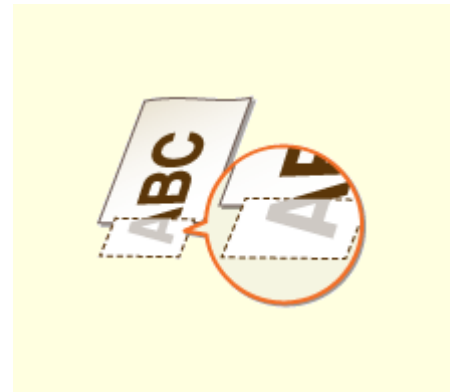

▶ A Portion of the Page Is Not Printed(P. 482)



▶ Streaks Appear/Printing is Uneven(P. 482)

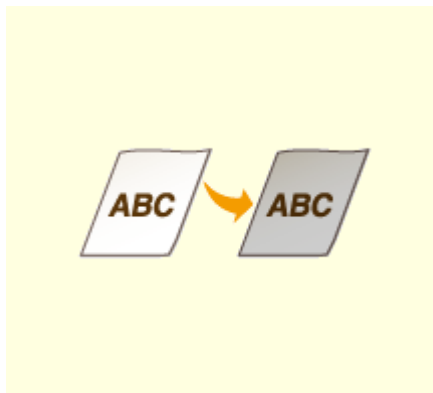

▶ Printouts Are Entirely or Partially Grayish(P. 483)



▶ White Spots Appear(P. 484)



▶ Spots Appear(P. 485)



▶ Reverse Side of Paper is Smudged(P. 486)

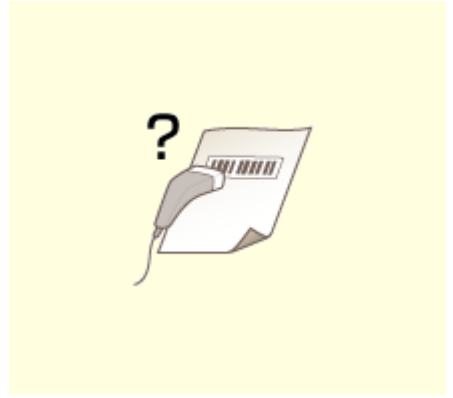

▶ Printed Barcode Cannot Be Read(P. 486)

■ Problems with Printout Paper ▶ Paper Creases or Curls(P. 487)



▶ Paper Creases(P. 487)



▶ Paper Curls(P. 487)

■ Problems with Paper Feed ▶ Paper Is Fed Incorrectly(P. 489)

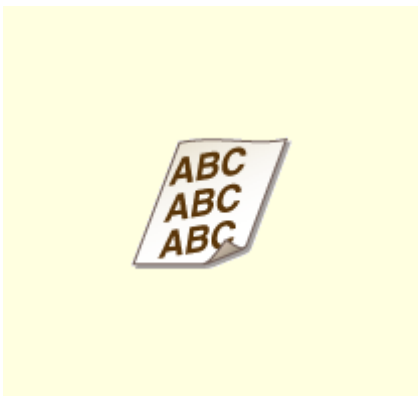

▶ Printouts Are Skewed(P. 489)



▶ Paper Is Not Fed/Two or More Sheets Are Fed Together(P. 489)

# Printing Results Are Not Satisfactory

2KUU-08S

Dirt inside the machine may affect printing results. Perform care and cleaning to the machine first. **▶Regular Cleaning(P. 432)**

## Smudge Marks Appear on the Edge of Printouts

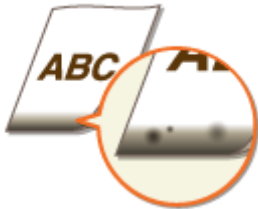

### → Are you using appropriate paper?

- Check the supported paper types and replace with an appropriate type. Also, set the paper size and type correctly.
  - ▶ **Available Paper(P. 538)**
  - ▶ **Loading Paper(P. 132)**
  - ▶ **Specifying Paper Size and Type(P. 145)**

### → Do you print data without margins?

- This symptom occurs if a margin is set to none in the printer driver. A margin of 1/4" (5 mm) or less around the edge of paper or 3/8" (10 mm) or less around the edge of envelopes is not printable with the machine. Make sure to have margins around the document to print.

[Finishing] tab ▶ [Advanced Settings] ▶ [Expand Print Region and Print] ▶ [Off]

## Smudges Appear on Printouts



### → Are you using appropriate paper?

- Check usable paper, and replace with appropriate paper.
  - ▶ **Available Paper(P. 538)**
  - ▶ **Loading Paper(P. 132)**
- If using the appropriate paper still does not solve the problem, changing the <Special Printing Mode A> or <Special Printing Mode Z> setting may solve the problem. <Mode 2> can improve the quality more significantly than <Mode 1>.

▶<Special Processing>(P. 416)

## Afterimages Appear in Blank Areas



### → Are you using appropriate paper?

- Check usable paper, and replace with appropriate paper.
  - ▶ Available Paper(P. 538)
  - ▶ Loading Paper(P. 132)

### → Is the amount remaining in the toner cartridge running low?

- Check how much the amount remaining in the toner cartridge is left, and replace the toner cartridge as necessary.
- Regardless of the amount remaining in the toner cartridge, the toner cartridge may reach the end of its lifetime depending on the use environment or the deterioration of materials inside the toner cartridge.
  - ▶ Replacing the Toner Cartridge(P. 443)

### → Is the amount remaining in the drum cartridge running low?

- Check how much the amount remaining in the drum cartridge is left, and replace the drum cartridge as necessary.
- Regardless of the amount remaining in the drum cartridge, the drum cartridge may reach the end of its lifetime depending on the use environment or the deterioration of materials inside the drum cartridge.
  - ▶ Replacing the Drum Cartridge(P. 447)

## Toner Smudges and Splatters Appear



### → Are you using appropriate paper?

- Check usable paper, and replace with appropriate paper.
  - ▶ Available Paper(P. 538)
  - ▶ Loading Paper(P. 132)

- Setting <Special Printing Mode U> to <On> may solve the problem.  
▶<Special Processing>(P. 416)

### → Are you using paper containing much paper dust or other dust particles?

- Smudges may appear in a printout when the paper has a lot of paper dust or other dust particles. Setting <Special Printing Mode L> to <On> may solve the problem.  
▶<Special Processing>(P. 416)

### → Is the amount remaining in the toner cartridge running low?

- Check how much the amount remaining in the toner cartridge is left, and replace the toner cartridge as necessary.
- Regardless of the amount remaining in the toner cartridge, the toner cartridge may reach the end of its lifetime depending on the use environment or the deterioration of materials inside the toner cartridge.  
▶<Replacing the Toner Cartridge>(P. 443)

### → Is the amount remaining in the drum cartridge running low?

- Check how much the amount remaining in the drum cartridge is left, and replace the drum cartridge as necessary.
- Regardless of the amount remaining in the drum cartridge, the drum cartridge may reach the end of its lifetime depending on the use environment or the deterioration of materials inside the drum cartridge.  
▶<Replacing the Drum Cartridge>(P. 447)

## Printouts Are Faded



### → Are you using appropriate paper?

- Check usable paper, and replace with appropriate paper. Also, specify the paper size and type settings properly.  
▶<Available Paper>(P. 538)  
▶<Loading Paper>(P. 132)  
▶<Specifying Paper Size and Type>(P. 145)

### → Are you using paper containing much paper dust?

- Using paper containing much paper dust may result in a faded or streaky printout. Setting <Special Printing Mode G> to <On> may solve the problem.  
▶<Special Processing>(P. 416)

### → Are you using rough-surface paper?

- Printed images may be faint when they are printed on rough-surface paper. Setting <Special Printing Mode Q> to <On> may solve the problem.  
▶<Special Processing>(P. 416)

#### NOTE:

- Setting this to <On> may affect the image quality.

### → Are you using the machine in an environment with high humidity?

- Setting <Special Printing Mode T> to <On> may solve the problem.  
▶<Special Processing>(P. 416)

#### NOTE:

- Printed images or text may be blurred when you set this to <On> and print in a low-humidity environment.

### → Did you print on the back of a printed sheet?

- Printing may be faint when you print on the back of a printed sheet. Setting <Special Printing Mode R> to <On> may solve the problem.  
▶<Special Processing>(P. 416)

#### NOTE:

- If you set to <On>, image quality may be affected or a paper jam may occur when a certain length of time elapses after printing on the front side or depending on the ambient humidity.

### → Is the machine installed in the appropriate environment?

- Install the printer in an appropriate location.  
▶Relocating the Machine(P. 452)

### → Is the amount remaining in the toner cartridge running low?

- Check how much the amount remaining in the toner cartridge is left, and replace the toner cartridge as necessary.
- Regardless of the amount remaining in the toner cartridge, the toner cartridge may reach the end of its lifetime depending on the use environment or the deterioration of materials inside the toner cartridge.  
▶Replacing the Toner Cartridge(P. 443)

### → Is the amount remaining in the drum cartridge running low?

- Check how much the amount remaining in the drum cartridge is left, and replace the drum cartridge as necessary.
- Regardless of the amount remaining in the drum cartridge, the drum cartridge may reach the end of its lifetime depending on the use environment or the deterioration of materials inside the drum cartridge.  
▶Replacing the Drum Cartridge(P. 447)



## A Portion of the Page Is Not Printed

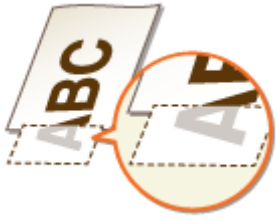

### → Do you print data without margins?

- This symptom occurs if a margin is set to none in the printer driver. A margin of 1/4" (5 mm) or less around the edge of paper or 3/8" (10 mm) or less around the edge of envelopes is not printable with the machine. Make sure to have margins around the document to print.

[Finishing] tab ▶ [Advanced Settings] ▶ [Expand Print Region and Print] ▶ [Off]

### → Do the paper guides align with the edges of the paper?

- If the paper guides are too loose or too tight, part of a document may not be printed.
  - ▶ **Loading Paper(P. 132)**

## Streaks Appear/Printing is Uneven



### → Are you using appropriate paper?

- Check usable paper, and replace with appropriate paper.
  - ▶ **Available Paper(P. 538)**
  - ▶ **Loading Paper(P. 132)**

### → Is the platen glass dirty?

- Clean the platen glass and the underside of the feeder.
  - ▶ **Cleaning the Platen Glass(P. 434)**

### → Have you cleaned the fixing unit?

- Clean the fixing unit.
  - ▶ **Cleaning the Fixing Assembly(P. 439)**

### → Are you using rough-surface paper?

- Printed images may be faint when they are printed on rough-surface paper. Setting <Special Printing Mode Q> to <On> may solve the problem.  
▶<Special Processing>(P. 416)

#### NOTE:

- Setting this to <On> may affect the image quality.

### → Are you using the machine in an environment with high humidity?

- Change the setting for <Special Printing Mode T>. Setting this item to <On> may solve the problem.  
▶<Special Processing>(P. 416)

#### NOTE:

- Printed images or text may be blurred when you set this to <On> and print in a low-humidity environment.

### → Are you using paper containing much paper dust?

- Using paper containing much paper dust may result in a faded or streaky printout. Setting <Special Printing Mode G> to <On> may solve the problem.  
▶<Special Processing>(P. 416)

### → Is the amount remaining in the toner cartridge running low?

- Check how much the amount remaining in the toner cartridge is left, and replace the toner cartridge as necessary.
- Regardless of the amount remaining in the toner cartridge, the toner cartridge may reach the end of its lifetime depending on the use environment or the deterioration of materials inside the toner cartridge.  
▶**Replacing the Toner Cartridge(P. 443)**

### → Is the amount remaining in the drum cartridge running low?

- Check how much the amount remaining in the drum cartridge is left, and replace the drum cartridge as necessary.
- Regardless of the amount remaining in the drum cartridge, the drum cartridge may reach the end of its lifetime depending on the use environment or the deterioration of materials inside the drum cartridge.  
▶**Replacing the Drum Cartridge(P. 447)**

## Printouts Are Entirely or Partially Grayish



→ Is <Correct Density> in <Copy Settings> set too dark?

- Adjust the setting so that density is lighter.  
 ▶<Correct Density>(P. 388)

→ Does the original have background color, is it stained, or are you copying an original such as a newspaper that is printed on thin paper so that text or images on the other side are visible through the paper?

- Check the original and then adjust the density to the correct settings.  
 ▶Basic Copy Operations(P. 173)

→ Are you using a specific type of paper?

- The printed side may come out in grayish color for certain type of paper. Check the type of paper you are using and try a different type.  
 ▶Available Paper(P. 538)
- Setting <Special Printing Mode U> or <Special Printing Mode G> to <On> may solve the problem.  
 ▶<Special Processing>(P. 416)

**NOTE:**

- A desirable effect may not be attained even with these settings applied.

→ Is the machine installed in the appropriate environment?

- Install the printer in an appropriate location.
- Store the toner cartridge in an appropriate location for two to three hours, then try printing again. This may solve the problem. If the problem persists, replace the toner cartridge.  
 ▶Replacing the Toner Cartridge(P. 443)

→ Has the drum cartridge been left in direct sunlight for a long period of time?

- Store the drum cartridge in an appropriate location for two to three hours, then try printing again. This may solve the problem. If the problem persists, replace the drum cartridge.  
 ▶Replacing the Drum Cartridge(P. 447)

White Spots Appear



→ **Are you using paper that has absorbed moisture?**

- Replace with appropriate paper.  
▶ **Loading Paper(P. 132)**

→ **Are you using appropriate paper?**

- Check usable paper, and replace with appropriate paper.  
▶ **Available Paper(P. 538)**  
▶ **Loading Paper(P. 132)**

→ **Is the amount remaining in the toner cartridge running low?**

- Check how much the amount remaining in the toner cartridge is left, and replace the toner cartridge as necessary.
- Regardless of the amount remaining in the toner cartridge, the toner cartridge may reach the end of its lifetime depending on the use environment or the deterioration of materials inside the toner cartridge.  
▶ **Replacing the Toner Cartridge(P. 443)**

→ **Is the amount remaining in the drum cartridge running low?**

- Check how much the amount remaining in the drum cartridge is left, and replace the drum cartridge as necessary.
- Regardless of the amount remaining in the drum cartridge, the drum cartridge may reach the end of its lifetime depending on the use environment or the deterioration of materials inside the drum cartridge.  
▶ **Replacing the Drum Cartridge(P. 447)**

Spots Appear



→ **Have you cleaned the fixing unit?**

- Clean the fixing unit.  
▶ **Cleaning the Fixing Assembly(P. 439)**

## Reverse Side of Paper is Smudged



### → Have you loaded paper that is smaller than the size of the print data?

- Check to make sure that the paper size matches the size of the print data.

### → Have you cleaned the fixing unit?

- Clean the fixing unit.  
 ▶ **Cleaning the Fixing Assembly(P. 439)**

### → Do smudges appear on 2-sided printed paper?

- The back side of the paper may become smudged during 2-sided printing. Setting <Special Printing Mode R> to <On> may solve the problem.  
 ▶ **<Special Processing>(P. 416)**

### NOTE:

- If you set to <On>, image quality may be affected or a paper jam may occur when a certain length of time elapses after printing on the front side or depending on the ambient humidity.

## Printed Barcode Cannot Be Read



### → Are you trying to read a small barcode or one with thick lines?

- Enlarge the barcode.
- Changing the <Select Line Width> setting may solve the problem.  
 ▶ **<Special Processing>(P. 416)**

# Paper Creases or Curls

2KUU-08U

## Paper Creases



### → Is paper loaded correctly?

- If paper is not loaded below the load limit line or is loaded obliquely, it may crease.  
▶ **Loading Paper(P. 132)**

### → Are you using paper that has absorbed moisture?

- Replace with appropriate paper.  
▶ **Loading Paper(P. 132)**

### → Are you using appropriate paper?

- Check usable paper, and replace with appropriate paper.  
▶ **Available Paper(P. 538)**  
▶ **Loading Paper(P. 132)**

## Paper Curls



### → Are you using appropriate paper?

- Check usable paper, and replace with appropriate paper. Also, specify the paper size and type settings properly.  
▶ **Available Paper(P. 538)**  
▶ **Loading Paper(P. 132)**  
▶ **Specifying Paper Size and Type(P. 145)**
- Change the setting of <Paper Type> to a setting for thinner paper. For example, if the current setting is <Plain (19 lb Bond-23 lb Bond)>, change it to <Plain L (17 lb Bond-18 lb Bond)> or <Plain L2 (16 lb Bond)>.

▶ **Specifying Paper Size and Type(P. 145)**

▶ **Available Paper(P. 538)**

- Reload the paper by changing the side to print on (front side/back side).

### **IMPORTANT:**

- In rare cases the symptom may become worse depending on the paper. If this occurs, change the side to print on back to the previous side.

### **→ Are you using paper that has absorbed moisture?**

- Replace with appropriate paper.
  - ▶ **Loading Paper(P. 132)**

## Paper Is Fed Incorrectly

2KUU-08W

### Printouts Are Skewed



#### → Do the paper guides align with the edges of the paper?

- If the paper guides are too loose or too tight, the printouts are skewed.  
▶ **Loading Paper(P. 132)**

#### → Are you printing on curled envelopes?

- Uncurl the envelopes, and print again.  
▶ **Loading Envelopes(P. 141)**

### Paper Is Not Fed/Two or More Sheets Are Fed Together



#### → Is paper loaded correctly?

- Fan the paper stack thoroughly so that paper is not stuck together.
- Check whether paper is loaded correctly.  
▶ **Loading Paper(P. 132)**
- Check whether the number of sheets of paper loaded is appropriate and whether the appropriate paper is used.  
▶ **Available Paper(P. 538)**  
▶ **Loading Paper(P. 132)**
- Check whether mixed sizes and types of paper are loaded together.
- There are cases where the paper does not load properly depending on its thickness. If this occurs, reverse the paper orientation, or flip the paper over.



## A Message or a Number Starting with "#" (an Error Code) Is Displayed

---

2KUU-08X

When a message appears on the machine's display, or a number (error code) prefixed with "#" appears, see the following sections to check the solution.

- ▶ **Countermeasures for Each Message(P. 491)**
- ▶ **Countermeasures for Each Error Code(P. 504)**

## Countermeasures for Each Message

2KUU-08Y

If you cannot send a fax or the memory is full, or you encounter operation problems, a message appears on the display. Find out more information about messages in the following list.

A counterfeit or non-Canon drum cartridge may be in use. The amount remaining in the cartridge cannot be displayed correctly./A counterfeit or non-Canon drum cartridge may be in use.

**The drum cartridge used may not be a genuine Canon product.**

- Only genuine Canon drum cartridges should be used as replacement drum cartridges.  
▶ **Consumables(P. 460)**

A counterfeit or non-Canon toner cartridge may be in use. The amount remaining in the cartridge cannot be displayed correctly./A counterfeit or non-Canon toner cartridge may be in use.

**The toner cartridge used may not be a genuine Canon product.**

- Only genuine Canon toner cartridges should be used as replacement toner cartridges.  
▶ **Consumables(P. 460)**

Amount remaining in drum cart. cannot be displayed correctly./Amount in cart. cannot be displ. correctly. (for drum cartridge)

**The drum cartridge is not installed correctly, or there is possible trouble on the drum cartridge.**

- Reinstall the drum cartridge. If this message does not disappear after reinstalling several times, the drum cartridge might be possibly broken. Contact the store where you purchased the drum cartridge, or consult the Canon Customer Help Center.  
▶ **Replacing the Drum Cartridge(P. 447)**

**You might not be using a Canon genuine drum cartridge.**

- We recommend Canon genuine drum cartridges as replacement drum cartridges.  
▶ **Consumables(P. 460)**

Amount remaining in tnr. cart. cannot be displayed correctly./Amount in cart. cannot be displ. correctly. (for toner cartridge)

**The toner cartridge is not installed correctly, or there is possible trouble on the toner cartridge.**

- Reinstall the toner cartridge. If this message does not disappear after reinstalling several times, the toner cartridge might be possibly broken. Contact the store where you purchased the toner cartridge, or consult the Canon Customer Help Center.  
 ▶ **Replacing the Toner Cartridge(P. 443)**

**You might not be using a Canon genuine toner cartridge.**

- We recommend Canon genuine toner cartridges as replacement toner cartridges.  
 ▶ **Consumables(P. 460)**

**Cannot change the destination type of any destination that is registered to a group.**

**A selected destination could not be edited because it was registered to Group Dial.**

- To change the type of destination that is registered to Group Dial, first delete the registered destination from Group Dial. Next, change the destination type, and then register the destination to Group Dial again.

**Cannot connect using Direct Connection.**

**An error has occurred while starting Access Point Mode.**

- Set an IP address other than "192.168.22.xx". If you still cannot connect, check the subnet mask setting. For details, contact your Network Administrator.  
 ▶ **Setting IPv4 Address(P. 32)**

**Cannot connect using Direct Connection. Check the network connection.**

**Access Point Mode was started without the device being connected to the access point.**

- Start Access Point Mode after connecting the device with the access point.

**Cannot export. An error has been detected during file creation.**

**Exporting the address book failed.**

- Check the USB cable connecting the machine to a computer.
- Check if you have access permission to the destination folder of the address book on the computer.  
 ▶ **Importing/Exporting Address Book Data with the Supplied Software(P. 353)**

**NOTE:**

You cannot access or edit the address book if you do not have access permission to the destination folder of the address book. If you do not have permission, log on as a user with access privileges, or change the destination for saving the address book.

## Cannot find the access point.

**When automatic setting with WPS was attempted, a wireless router could not be detected within a specific period of time.**

- Connect again paying attention to the time limit.
  - ▶ **Setting Up Connection Using WPS Push Button Mode(P. 20)**
  - ▶ **Setting Up Connection Using WPS PIN Code Mode(P. 22)**

**An SSID of a wireless router was entered, but the entry was incorrect.**

- Check the SSID and enter the correct one again.
  - ▶ **Checking the SSID and Network Key(P. 30)**
  - ▶ **Setting Up Connection by Specifying Detailed Settings(P. 27)**

**A wireless router could not be detected due to setting problems of the network to be connected.**

- Check whether the machine is properly installed and ready to connect to the network.
  - ▶ **Installation/Settings Problems(P. 467)**
- If the problem persists, check the security settings of the wireless router.

## Cannot import. A file error has been detected.

**Importing the address book failed.**

- Check the USB cable connecting the machine to a computer.
- Check if the contents of address book to be imported is correct.
  - ▶ **Importing/Exporting Address Book Data with the Supplied Software(P. 353)**

## Cannot print RX data.

**A received document cannot be printed due to the following:**

- Replacement period of the toner cartridge or the drum cartridge is near.
- A cover is opened.
- The toner cartridge or the drum cartridge is not set.
- Paper is not set.
- An original or paper jams.
- An error has occurred.
- Check whether the problems above are occurring. If messages including causes and solutions appear on the display, check the contents.

## Cannot receive the fax. Make sure the fax was sent correctly by the sender.

**The recipient's machine did not respond within 35 seconds.**

- Ask the sender to send the fax again. If you hear a beep, select <Start Receiving> to receive the fax.
  - ▶ **Receiving Faxes(P. 203)**

## Cannot send because more than one destination is specified.

### **Sending a fax to multiple destinations is disabled.**

- To specify multiple destinations, you need to set <Restrict Sequential Broadcast> to <Off> or <Confirm Sequential Broadcast>. For more information, contact your Administrator.  
 ▶ **Restricting Sequential Broadcasts(P. 329)**

## Cannot specify a group.

### **Group Dial was specified as a destination after pressing <Hook>.**

- Once you select <Hook>, you cannot specify destinations in Group Dial. Select <End> on the <Specify destination.> screen, and specify destinations to send fax documents without selecting <Hook>.

## Cannot use Google Cloud Print. Server authentication failed./Google Cloud Print not avail. Server auth err

### **Cloud Print could not perform server authentication, or could not acquire information for registration.**

- Check whether the date and time settings are correctly specified.  
 ▶ **<Date/Time Settings>(P. 381)**

## Cannot use Google Cloud Print. Server communication error./Google Cloud Print not avail. Server comm err

### **Cloud Print is unavailable due to an error.**

Check whether the machine is correctly connected to a wired LAN or a wireless LAN.

- ▶ **Connecting to a Wired LAN(P. 17)**
- ▶ **Connecting to a Wireless LAN(P. 18)**

- A port that is used for Cloud Print may be blocked by a firewall or other protection. Check whether the 5222 port is available with your computer.
- If a proxy server is used on the network, check whether the proxy settings on the machine and the server are correct. For details, contact your Network Administrator.  
 ▶ **Setting a Proxy(P. 306)**

## Cartridge communication error. A counterfeit or non-Canon drum cartridge may be in use./Cart. Comm. Error A counterfeit or non-Canon drum cart. may be in use.

### **The drum cartridge may not be installed correctly or may be faulty.**

- Re-install the drum cartridge. If re-installing the drum cartridge fails to clear the error message, the drum cartridge may be faulty. Contact the store where you purchased the drum cartridge or consult the Canon Customer Help Center.  
 ▶ **Procedure for Replacing the Drum Cartridge(P. 448)**

**Cartridge communication error. A counterfeit or non-Canon toner cartridge may be in use./Cart. Comm. Error A counterfeit or non-Canon toner cart. may be in use.**

**The toner cartridge may not be installed correctly or may be faulty.**

- Re-install the toner cartridge. If re-installing the toner cartridge fails to clear the error message, the toner cartridge may be faulty. Contact the store where you purchased the toner cartridge or consult the Canon Customer Help Center.  
 ▶ **Procedure for Replacing the Toner Cartridge(P. 444)**

**Check the authentication settings.**

**The authentication method set on the machine does not match the authentication method set on the RADIUS server.**

- Check that the same authentication method is set on this machine and the RADIUS server, and set the correct authentication method.  
 ▶ **Configuring IEEE 802.1X Authentication Settings(P. 318)**

**Cooling down... Wait a moment, then try again.**

**The temperature of the fixing assembly is high.**

- Wait for a while until the fixing assembly cools down. After the temperature of the fixing assembly falls, try the operation again.

**Cooling down... Wait a moment.**

**The temperature of the fixing assembly is high.**

- Wait for a while until the fixing assembly cools down. After the temperature of the fixing assembly falls, the message will disappear.

**Could not connect. (for Access Point Mode connection)**

**Connection in Access Point Mode failed due to an error.**

- Wait a few moments and try again. If you still cannot connect, turn OFF the machine, and then turn it back on again.  
 ▶ **Connecting Directly (Access Point Mode)(P. 269)**

## Could not connect. (for Easy Connection via PC connection)

### An error has occurred while starting Easy Connection via PC (cableless setup mode).

- Press  to return to the previous screen, and then try <Easy Connection via PC> again.
- If the same message still appears after retrying <Easy Connection via PC>, turn OFF the machine, and then turn it back on again.

## Could not connect. Check the PSK settings.

### The network key (PSK) of a wireless router to be connected is not set to the machine correctly.

- Check the network key (PSK) of the wireless router, and set it to the machine again.
  - ▶ **Checking the SSID and Network Key(P. 30)**
  - ▶ **Setting Up Connection by Selecting a Wireless Router(P. 24)**
  - ▶ **Setting Up Connection by Specifying Detailed Settings(P. 27)**
- If the problem persists even after checking the network key, check whether the machine is properly installed and ready to connect to the network.
  - ▶ **Installation/Settings Problems(P. 467)**

## Could not connect using the wireless LAN. Turn the main power OFF and ON, then configure the settings again./Could not connect using the wireless LAN.

### A connection failed due to an error while setting wireless LAN connection.

- Restart the machine and set again.
- If the problem persists even after restarting the machine, check whether the machine is properly installed and ready to connect to the network.
  - ▶ **Installation/Settings Problems(P. 467)**
- If the problem persists even after checking the wireless LAN connection, check the security settings of the wireless router.

## Could not connect using WPS. Wait a moment, then configure the settings again./Could not connect using WPS.

### When automatic setting with WPS was attempted, the connection failed due to an error.

- Wait for a while, and set again. If the problem persists, check whether the wireless router supports WPS.

#### If WPS is supported:

Check whether the machine is properly installed and ready to connect to the network.

- ▶ **Installation/Settings Problems(P. 467)**

#### If WPS is not supported:

Set using another connecting method.

- ▶ **Connecting to a Wireless LAN(P. 18)**

## Could not detect any connections from wireless devices.

**It was not possible to detect any mobile device within the predetermined length of time.**

- Connect again paying attention to the time limit.
  - ▶ **Connecting Directly (Access Point Mode)(P. 269)**

## Could not perform cleaning.

**Paper jammed during cleaning.**

- Remove the jammed paper, set paper correctly, and perform cleaning again.
  - ▶ **Paper Jams inside the Machine(P. 514)**
  - ▶ **Cleaning the Fixing Assembly(P. 439)**

## Could not perform Shared Key authentication. Check the WEP settings./ Could not perform Shared Key auth. Check WEP settings.

**The network key (the WEP key) of a wireless router to be connected is not set to the machine correctly.**

- Check the network key (the WEP key) of the wireless router, and set it to the machine again.
  - ▶ **Checking the SSID and Network Key(P. 30)**
  - ▶ **Setting Up Connection by Specifying Detailed Settings(P. 27)**
- Connect again by selecting a wireless router or by manually changing the WEP authentication method to <Open System>.
  - ▶ **Setting Up Connection by Selecting a Wireless Router(P. 24)**
  - ▶ **Setting Up Connection by Specifying Detailed Settings(P. 27)**

**The authentication method of the machine is set to <Shared Key>, but that of the wireless router is set to "Open System."**

- Change the WEP authentication method to "Shared Key" at the wireless router, and connect again. For more information about how to change, see the instruction manuals for your networking devices or contact your manufacturer.

## Could not set the current date and time.

**The communication failed due to a network error and a timeout occurred.**

- Check the network environment that the machine connects with.
- Use <Current Date/Time Settings> to set the time manually, or, in [SNTP Settings], clear the [Use SNTP] check box.
  - ▶ **Setting the Current Date and Time(P. 11)**
  - ▶ **Configuring SNTP(P. 67)**



Could not update the device time because its battery has run out. Cannot use Google Cloud Print if the time settings are incorrect.

**The machine's battery has run out and the correct time settings could not be kept.**

- Set the correct time again.
  - ▶ **Setting the Current Date and Time(P. 11)**

Direct Connection terminated.

**Connection with the mobile device was interrupted.**

- Establish Direct Connection again.
  - ▶ **Connecting Directly (Access Point Mode)(P. 269)**

Direct Connection terminated. Check the network connection./Direct Connection terminated. Check network connection.

**Connection with the mobile device was interrupted.**

- Establish Direct Connection again.
  - ▶ **Connecting Directly (Access Point Mode)(P. 269)**

Drum cart. end of lifetime. Replacement is recommended./Drum cart. life end. Replcmt. recommended.

**The drum cartridge has reached the end of its lifetime.**

- Replacement of the drum cartridge is recommended.
  - ▶ **Replacing the Drum Cartridge(P. 447)**

Easy Connection via PC ended because the session timed out./Easy Connection via PC ended due to timeout.

**A connection to the computer has not been established for 30 minutes since Easy Connection via PC (cableless setup mode) started.**

- Press  to return to the previous screen, and then try <Easy Connection via PC> again.

Insert the drum cartridge.

**The drum cartridge is not set or properly set.**

- Properly set the drum cartridge.  
 ▶ **Replacing the Drum Cartridge(P. 447)**

**Insert the toner cartridge.**

**The toner cartridge is not set or properly set.**

- Properly set the toner cartridge.  
 ▶ **Replacing the Toner Cartridge(P. 443)**

**Maximum number of wireless devices connected using Direct Connection has been reached. To connect other devices, terminate some of the current connections./Maximum number of wireless devices connected w/ Direct Connection has been reached. To connect other devices, terminate some of current connections.**

**The number of directly connected mobile devices is at a maximum.**

- To connect other devices by Direct Connection, disconnect current device(s) and try connecting again.  
 ▶ **Connecting Directly (Access Point Mode)(P. 269)**

**No Paper: XXXX\***

\* <Drawer 1> or <MP Tray> is displayed for XXXX.

**Paper is not loaded in the drawer or the multi-purpose tray.**

- Load the paper.  
 ▶ **Loading Paper(P. 132)**

**Paper on which reports or lists can be printed is not loaded.**

- Reports or lists can be printed on A4 or Letter size paper. Load A4 or Letter size paper and set its size.  
 ▶ **Loading Paper(P. 132)**  
 ▶ **Specifying Paper Size and Type(P. 145)**

**Paper on which received documents can be printed is not loaded.**

- Received documents can be printed on A4 or Letter size paper. Load A4 or Letter size paper and set its size. Also, set the paper type to <Plain (19 lb Bond-23 lb Bond)>, <Plain L (17 lb Bond-18 lb Bond)>, or <Recycled (19 lb Bond-23 lb Bond)> depending on the loaded paper.  
 ▶ **Loading Paper(P. 132)**  
 ▶ **Specifying Paper Size and Type(P. 145)**

**NOTE:**

If you print received documents on paper other than A4 or Letter size, some portions of the image may be missing or the image may be divided and printed onto several sheets.

## No reply from the destination.

**A network cable may be disconnected, or there may be a problem in a switch.**

- Check the status of the network cables and switches.

## No response from the host./No response from host.

**The machine is not connected to a network correctly.**

- Check the machine and network settings, and connect again.  
▶ **Setting Up the Network Environment(P. 14)**

## Paper jammed.

**Paper jams.**

- Remove the jammed paper, and print again (Printing may resume automatically).  
▶ **Clearing Paper Jams(P. 510)**

## Preparing a drum cartridge is recommended./Preparing a drum cart. is recommended.

**Drum cartridge replacement time is near.**

- Replace the drum cartridge if you see this message before you start to print a large job.  
▶ **Consumables(P. 460)**

## Preparing a toner cartridge is recommended./Preparing a toner cart. is recommended.

**Toner cartridge replacement time is near.**

- Replace the toner cartridge if you see this message before you start to print a large job.  
▶ **Consumables(P. 460)**

## Set the correct authentication information.

**The client authentication information (key and certificate, user name and password, or CA certificate) is not set correctly.**

- Check the specified authentication method and authentication information (key and certificate, user name and password, and CA certificate).  
▶ **Configuring IEEE 802.1X Authentication Settings(P. 318)**

## Size/Settings Mismatch

**The paper size setting on the operation panel does not match the loaded paper size.**

- Match the paper size setting specified in <Paper Settings> and the size of the paper that is actually loaded.

### To use the loaded paper

Change the setting of <Paper Settings> to match the loaded paper size.

▶ **Specifying Paper Size and Type(P. 145)**

### NOTE:

If printing from a computer, check whether the paper size setting in the printer driver matches the loaded paper size.

### To load paper without changing the settings

Load the paper with the size that is set to <Paper Settings>.

▶ **Loading Paper(P. 132)**

## Specifying and registering new destinations is restricted.

**Only destinations that are registered in the Address Book can be specified to send a fax or e-mail.**

- To enter a new destination with the operation panel, or add or edit it in the Address Book, you need to set <Restrict New Destinations> to <Off>. For more information, contact your Administrator.

▶ **Restricting New Destinations that Can Be Specified(P. 327)**

## The connection with the PC has been lost. Check the connection.

**The connection to the computer was lost during a scan.**

- Check the connection between the machine and the computer.

▶ **Preparing to Use the Machine as a Scanner(P. 77)**

## The drum cartridge has reached the end of its lifetime./Drum cart. reached end of lifetime.

**The drum cartridge has reached the end of its lifetime.**

- Replace the drum cartridge with a new one.

▶ **Replacing the Drum Cartridge(P. 447)**

## The memory is full.

**A fax could not be sent or received, or an original could not be scanned due to insufficient memory space.**

- If a sending or printing job is queued, wait until the job is completed.
- If a received document is stored to memory, print or delete it.

- ▶ **Saving Received Documents into the Machine (Memory Reception)(P. 213)**
- If sending an original with many pages, divide it into multiple sections.
- If sending a fax, reduce the resolution to scan the original.
- ▶ **Basic Operations for Sending Faxes(P. 195)**
- If scanning, change the file format to reduce its file size.
- ▶ **Basic Operations for Scanning Originals(P. 233)**

The memory is full. Scanning will be canceled. Do you want to print?/The memory is full. Scanning will be canceled. Print?

**The document being printed contains a page with a very large amount of data.**

- Select whether to print as far as the portion scanned into memory or to cancel the job.
- Copy the document in two or more parts.

The number of entered characters is incorrect or invalid characters are used./Incorrect number of characters/invalid characters entered.

**The network key (the WPA/WPA2-PSK or WEP key) of a wireless router is not entered correctly.**

- Check the network key (the WPA/WPA2-PSK or WEP key) of the wireless router, and set it to the machine again. For more information about how to check the network key, see the instruction manuals for your networking devices or contact your manufacturer.
- ▶ **Checking the SSID and Network Key(P. 30)**
- ▶ **Setting Up Connection by Selecting a Wireless Router(P. 24)**
- ▶ **Setting Up Connection by Specifying Detailed Settings(P. 27)**

The WEP key is not set correctly. Check the WEP settings.

**The network key (the WEP key) of a wireless router to be connected is not set to the machine correctly.**

- Check the network key (the WEP key) of the wireless router, and set it to the machine again.
- ▶ **Checking the SSID and Network Key(P. 30)**
- ▶ **Setting Up Connection by Selecting a Wireless Router(P. 24)**
- ▶ **Setting Up Connection by Specifying Detailed Settings(P. 27)**

**The authentication method of the machine is set to <Shared Key>, but that of the wireless router is set to "Open System."**

- Connect again by selecting a wireless router or by manually changing the WEP authentication method to <Open System>.
- ▶ **Setting Up Connection by Selecting a Wireless Router(P. 24)**
- ▶ **Setting Up Connection by Specifying Detailed Settings(P. 27)**
- Change the WEP authentication method to "Shared Key" at the wireless router, and connect again. For more information about how to change, see the instruction manuals for your networking devices or contact your manufacturer.

Toner cart. end of lifetime. Replacement is recommended./Toner cart. life end. Replcmt. recommended.

**The toner cartridge has reached the end of its lifetime.**

- Replacement of the toner cartridge is recommended.
- ▶ **Replacing the Toner Cartridge(P. 443)**

Toner cartridge has reached the end of its lifetime./Toner cart. reached end of lifetime.

**The toner cartridge has reached the end of its lifetime.**

- Replace the toner cartridge with a new one.
- ▶ **Replacing the Toner Cartridge(P. 443)**

Turn the main power OFF and ON. If the device does not recover, contact your dealer or service representative.

**An error has occurred with the machine.**

- Turn OFF the power switch, wait 10 seconds, and turn it back ON. If the problem persists, turn OFF the power switch, disconnect the power cord, and contact your local authorized Canon dealer or the Canon help line. Be sure to provide the displayed <Ennn-nnnn>.

Use Remote UI to set the information necessary for authentication./Use Remote UI to set info. necessary for authentication.

**The IEEE 802.1X settings are incorrect.**

- Check whether [Login Name] is set correctly.
- Check whether the [Use TLS], [Use TTLS], or [Use PEAP] check box is selected.
- If using TLS, check whether a "key and certificate" is registered.
- If using TTLS or PEAP, check whether a user name and password are set correctly.
- ▶ **Configuring IEEE 802.1X Authentication Settings(P. 318)**

# Countermeasures for Each Error Code

2KUU-090

If printing is not successful or you cannot send or receive a fax or scanned document, or another error occurs, that error appears on a report or a message on the <Status Monitor> screen as a three-digit number (error code). Check the following to find out causes and solutions for each error code. For how to print an error report and information in the report, see **▶<Status Monitor> Screen(P. 115)** .

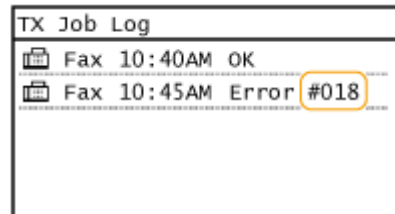
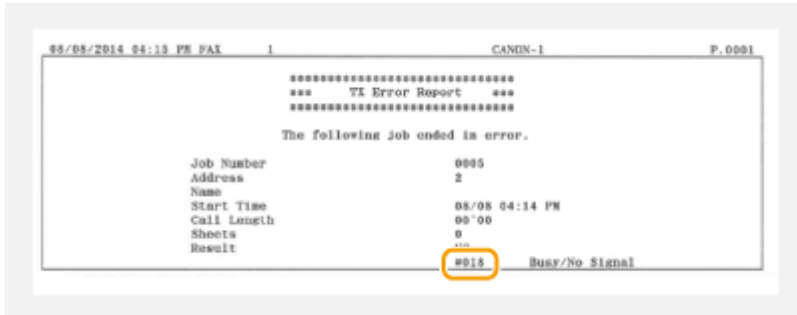

## #001

**An original jams in the feeder.**

- Remove the jammed original.
  - ▶**Paper Jams in the Feeder(P. 511)**

## #003

**A fax could not be sent or received due to its large data size.**

- When sending a fax: Reduce the resolution, and scan the original a portion at a time.
  - ▶**Basic Operations for Sending Faxes(P. 195)**
- When receiving a fax: Ask the sender to divide the original into multiple sections or reduce the resolution before sending.

## #005

**A fax could not be sent because the recipient's machine did not respond within 35 seconds.**

- When the recipient's machine is turned OFF or the line is busy, a fax may not be sent. Ask the recipient to check the machine status. When sending the fax overseas, insert pauses in the fax number.
  - ▶**Basic Operations for Sending Faxes(P. 195)**

## #012

**A fax could not be sent because the recipient's machine ran out of paper.**

- Ask the recipient to reload the paper.

## #018

**A fax could not be sent since the recipient's machine did not respond because the line was busy or for other reasons.**

- When the recipient's machine is turned OFF or the line is busy, a fax may not be sent. Ask the recipient to check the machine status. When sending the fax overseas, insert pauses in the fax number.
  - ▶ **Basic Operations for Sending Faxes(P. 195)**

## #022

**Sending of a fax from a computer is disabled.**

- To send a fax from a computer, you need to set <Allow Fax Driver TX> to <On>. For more information, contact your Administrator.
  - ▶ **Restricting Fax Sending from a Computer(P. 329)**

**A fax could not be forwarded because the specified destination was deleted from the Address Book.**

- Register the forwarding destination again. If the documents that failed to be forwarded remain in memory, you can forward it again.
  - ▶ **Registering Destinations(P. 161)**
  - ▶ **Printing/Resending/Deleting Documents that Failed to be Forwarded(P. 215)**

## #037

**Memory is full.**

- If a sending or printing job is queued, wait until the job is completed.
- If a received document is stored to memory, print or delete it.
  - ▶ **Saving Received Documents into the Machine (Memory Reception)(P. 213)**
- If sending a document with many pages, divide it into multiple sections.
- If sending a fax, reduce the resolution to scan the document.
  - ▶ **Basic Operations for Sending Faxes(P. 195)**
- If several destinations are specified in the fax driver, specify only one destination.

## #054

**A fax could not be sent because the specified destination fax number exceeded 40 digits.**

- Specify the destination fax number within 40 digits.

## #099

**Printing, sending, or receiving was canceled.**



- When you cancel an operation, this error code is displayed, but this is not abnormal. Print, send, or receive documents again as necessary.

## #752

### E-mail sending was impossible because an incorrect SMTP server name was set.

- Check the SMTP server name, and correct the setting.
  - ▶ **Configuring Basic E-Mail Settings(P. 79)**
  - ▶ **Configuring E-Mail Communication Settings(P. 82)**

### E-mail sending was impossible because an incorrect domain name was set.

- Check the domain name, and correct the setting.
  - ▶ **Configuring DNS(P. 57)**

### E-mail sending was impossible because the machine was not connected to a network correctly.

- Check whether the machine is properly installed and correctly connected to the network.
  - ▶ **Installation/Settings Problems(P. 467)**

## #753

### Scanned data could not be sent as e-mail or stored in the shared folder because the LAN cable is disconnected.

- Check whether the LAN cable is connected correctly.
  - ▶ **Connecting to a Wired LAN(P. 17)**

## #755

### Scanned data could not be sent as e-mail or stored in the shared folder because TCP/IP was not working correctly.

- Check <TCP/IP Settings>, and set correctly.
  - ▶ **<Network Settings>(P. 363)**

### An IP address is not set.

- Set the IP address correctly.
  - ▶ **Setting IP Addresses(P. 31)**

### The machine cannot communicate with devices on a network immediately after the machine starts up because the waiting time for the start of the communication is set.

- The machine cannot start communicating immediately after it is turned ON. Wait until the set time for <Waiting Time for Connection at Startup> passes after turning ON the machine, and send again.
  - ▶ **Setting a Wait Time for Connecting to a Network(P. 56)**

## #801

### When communicating with an SMTP server to send an e-mail, a timeout error occurred from the server.

- Check whether SMTP is running on the network correctly.
- Check whether the machine is properly installed and correctly connected to the network.  
**▶Installation/Settings Problems(P. 467)**

**When communicating with the SMTP server, an error returned from the server.**

- Check whether the SMTP server is set correctly.

**A destination is not set correctly.**

- Check whether the destination is set correctly.

**When storing a scanned original into the shared folder, an error occurred from the folder.**

- Check whether the shared folder and the computer that has the shared folder are running correctly.

**The incorrect folder name or password was specified when storing to the shared folder.**

- Check the destination settings.

## #802

**The SMTP/POP3 server name is not set correctly.**

- Set the SMTP/POP3 server name correctly.  
**▶Configuring Basic E-Mail Settings(P. 79)**  
**▶Configuring E-Mail Communication Settings(P. 82)**

## #804

**No access privileges to access the shared folder are granted.**

- Assign the privilege for writing data to the storage folder to the sender (user name registered in the destination). For details, contact your Network Administrator.

**The incorrect folder name was specified when storing to the shared folder.**

- Check the destination settings.

## #806

**When storing data to a shared folder, an incorrect user name or password was specified.**

- The same user name and password as those registered in a shared folder must be registered in the Address Book.  
**▶Setting a Shared Folder as a Save Location(P. 86)**  
**▶Registering Destinations from Remote UI(P. 347)**

**When sending an e-mail, an incorrect destination was specified.**

- Enter the correct e-mail address, and send the message again. If the destination that was registered in the Address Book was used, check whether the e-mail address is correct.  
**▶Registering Destinations(P. 161)**

## #810

**An error has been returned from the POP3 server when sending an e-mail.**

- Check whether the POP3 server is set correctly.
- Check whether your mail server and network are running correctly. For more information, contact your Network Administrator.

## #813

**The login name or the password that is used on the POP3 server is not set correctly.**

- Correctly enter login name or the password that is used on the POP3 server.

## #839

**A user name and password that are used for SMTP authentication are not set correctly.**

- Set the user name and password correctly.
  - ▶ **Configuring Basic E-Mail Settings(P. 79)**
  - ▶ **Configuring E-Mail Communication Settings(P. 82)**

## #841

**When sending an e-mail, an encryption algorithm that is common to the mail server is not present.**

- Clear the [Use TLS for SMTP] check box for the SMTP server.
  - ▶ **Configuring E-Mail Communication Settings(P. 82)**
- Add the common encryption algorithm to the mail server settings.

**A TLS server certificate verification error has occurred during communication with the SMTP server.**

- Check that the CA certificate that signed the TLS server certificate on the SMTP server side is registered to the machine by using the Remote UI.
- Check that the TLS server certificate on the SMTP server side is valid.
- Check that the TLS server certificate is not a self-signed certificate.

## #844

**TLS encrypted communication to a POP3 server failed when sending an e-mail with POP before SMTP.**

- Check the TLS encrypted communication settings in the POP3 server.
- Clear the [Use TLS for POP] check box for the POP3 server. If the problem persists, clear the [Use POP Authentication Before Sending] check box, and set the communication setting to a setting other than POP before SMTP.
  - ▶ **Configuring E-Mail Communication Settings(P. 82)**

**When verifying a TLS server certificate to communicate to the POP3 server, a verification error occurred.**

- Check that the CA certificate that signed the TLS server certificate on the POP3 server side is registered to the machine by using the Remote UI.
- Check that the TLS server certificate on the POP3 server side is valid.
- Check that the TLS server certificate is not a self-signed certificate.

#846

**An e-mail could not be sent due to a POP authentication failure.**

- Check the setting, and try again.  
 ▶ **Configuring E-Mail Communication Settings(P. 82)**

#852

**The machine turns OFF for some reason.**

- Check whether the power plug is inserted into an outlet firmly.

#853

**A document could not be printed because its data size exceeded the machine's upper processing capability.**

- The machine may not be able to print documents with many pages. Reduce the number of pages per printing, or print when no print job is queued or no document is being printed. If you are still unable to print, check the document data for any defects.

**Printing was canceled from the computer.**

- If you cancel an operation when the print data is being sent to the machine from a computer, this error code is displayed, but this is not abnormal. Print again as necessary.

**A PC fax was sent after setting a resolution not guaranteed on the machine.**

- Reduce the resolution setting in the fax driver.

#995

**A document waiting to be sent was canceled.**

- Send the document again as necessary.

# Clearing Paper Jams

2KUU-091

If a paper jams, <Paper jammed.> is displayed on the screen. Press <Next> (▶) to display simple solutions. If it is difficult to understand the procedures on the display, see the following sections to clear jams.

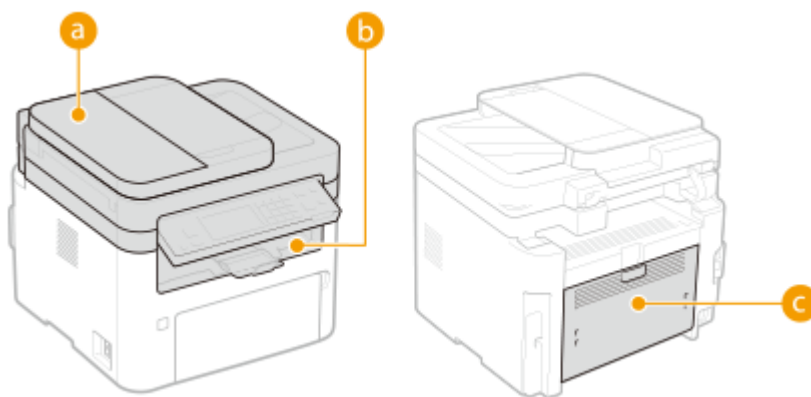
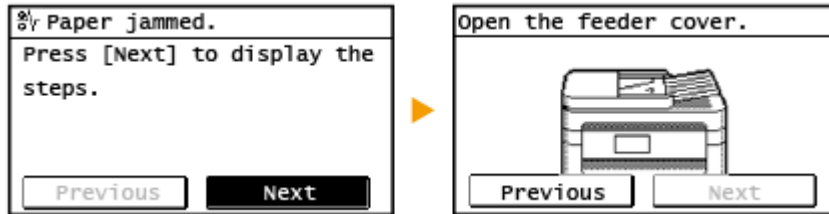

- a Feeder**
  - ▶ Paper Jams in the Feeder(P. 511)
- b Inside of the machine**
  - ▶ Paper Jams inside the Machine(P. 514)
- c Back side**
  - ▶ Paper Jams inside the Machine(P. 514)

## IMPORTANT

### When removing the jammed paper, do not turn OFF the machine

- Turning OFF the machine deletes the data that is being printed. Be especially careful when receiving fax documents.

### If paper tears

- Remove all the paper fragments to prevent them from becoming jammed.

### If paper jams repeatedly

- Tap the paper stack on a flat surface to even the edges of the paper before loading it into the machine.
- Check that the paper is appropriate for the machine. ▶ Available Paper(P. 538)
- Check that no jammed paper fragments remain in the machine.
- If you use paper with a coarse surface, set <Paper Type> to <Bond 1 (16 lb Bond-27 lb Bond)> or <Bond 2 (28 lb Bond-60 lb Cover)>.
  - ▶ Specifying Paper Size and Type in the Drawer(P. 146)
  - ▶ Specifying Paper Size and Type in the Multi-Purpose Tray(P. 147)
  - ▶ Printing from a Computer(P. 224)

### Do not forcibly remove the jammed paper from the machine

- Forcibly removing the paper may damage parts. If you are not able to remove the paper, contact your local authorized Canon dealer or the Canon help line. ▶ When a Problem Cannot Be Solved(P. 518)

# Paper Jams in the Feeder

2KUU-092

If there are originals placed in the feeder, remove them first. Then, follow the procedure below. Do not forcibly remove jammed paper from the machine. If the jammed paper cannot be removed easily, proceed to the next step.

- ▶ Paper Jams in the Feeder (MF269dw)(P. 511)
- ▶ Paper Jams in the Feeder (MF267dw / MF264dw)(P. 512)

## Paper Jams in the Feeder (MF269dw)

### 1 Remove the jammed original from the feeder cover.

- 1 Open the feeder cover.

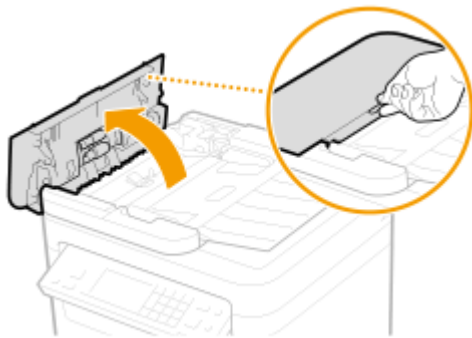

- 2 Move the lever to unlock.

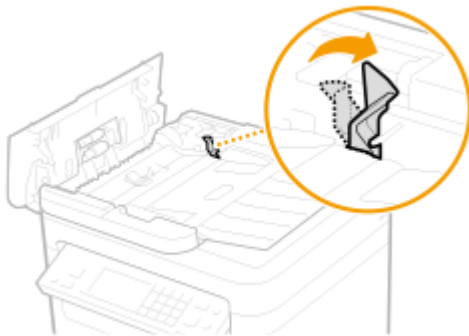

- 3 Gently pull out the original.

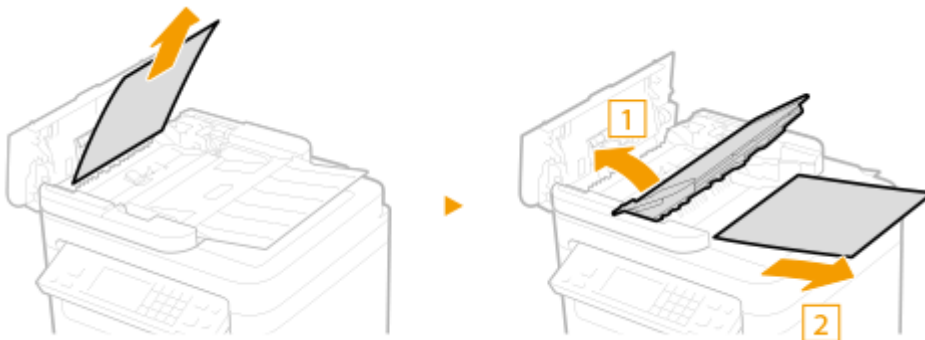

## 2 Remove the jammed original from the inner cover inside the feeder.

- 1 Hold the green knob, and open the inner cover.

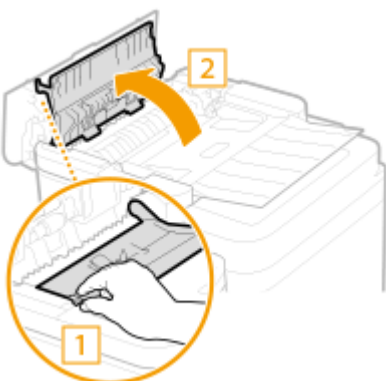

- 2 Gently pull out the original.



- 3 Close the inner cover.

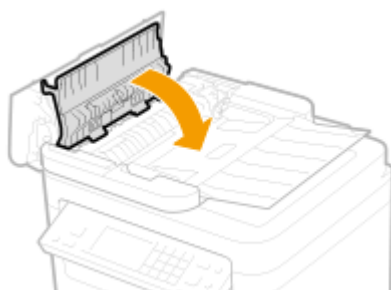

## 3 Return the lever back in place, and close the feeder cover.

## 4 Place the original again.

### Paper Jams in the Feeder (MF267dw / MF264dw)

- 1 Open the feeder cover.

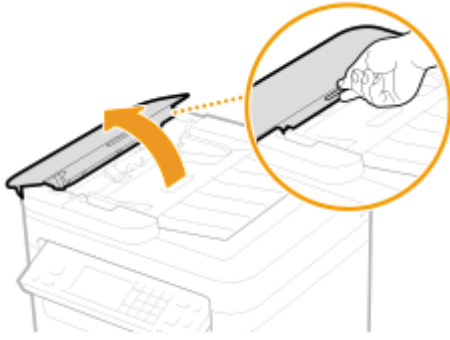

**2** Gently pull out the original.



**3** Close the feeder cover.

**4** Place the original again.



# Paper Jams inside the Machine

2KUU-093

Remove the jammed paper according to the procedure below. Do not forcibly remove jammed paper from the machine. If the jammed paper cannot be removed easily, proceed to the next step.

## 1 Lift the operation panel.

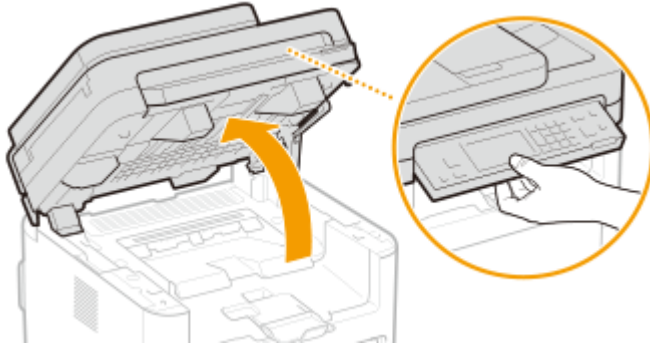

### IMPORTANT:

- The operation panel cannot be opened if the feeder is not completely closed. Forcing the operation panel up may cause damage.

## 2 Open the toner cover.

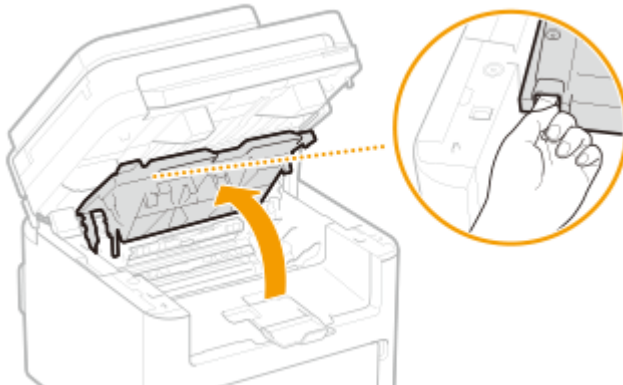

## 3 Remove the cartridges.

- 1 Remove the toner cartridge.

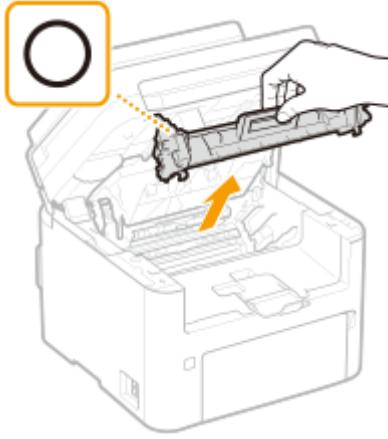

**IMPORTANT:**

Do not shake or tilt the toner cartridge. Also, make sure to avoid applying shocks to the toner cartridge, such as by hitting it against something. Doing so may cause the toner left in the toner cartridge to leak. Remove the toner cartridge gently at the same angle as the slot.

- 2 Remove the drum cartridge.

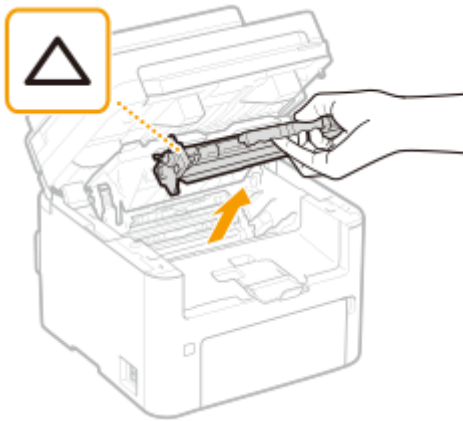

**IMPORTANT:**

Do not shake or tilt the drum cartridge. Also, make sure to avoid applying shocks to the drum cartridge, such as by hitting it against something. Doing so may cause the toner left in the drum cartridge to leak. Remove the drum cartridge gently at the same angle as the slot.

- 4 Gently pull out the paper.

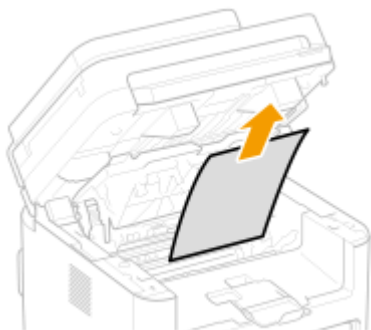

- 5 Check whether paper is jammed inside the paper exit guide.

- 1 Pull out toward you while pressing the button (a) to open the paper exit guide.

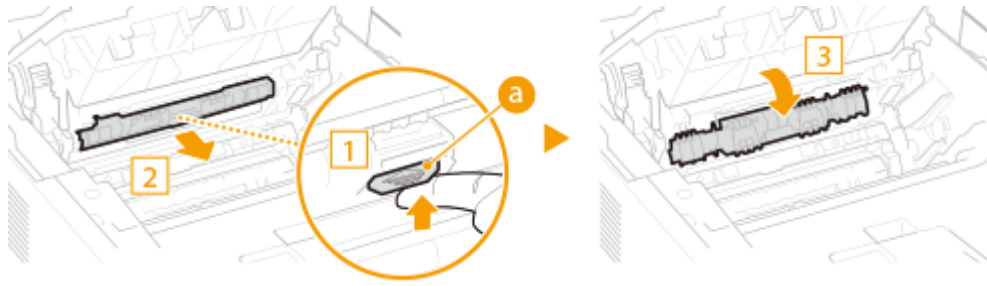

**2** Gently pull out the paper.

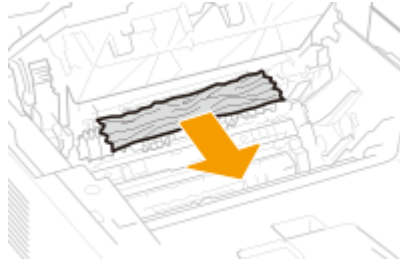

**3** Close the paper exit guide.

## **6** Check whether paper is jammed inside the machine.

**1** Gently pull out the paper.

- Hold both edges of the paper, pull the leading edge of the paper down, and then pull it out.

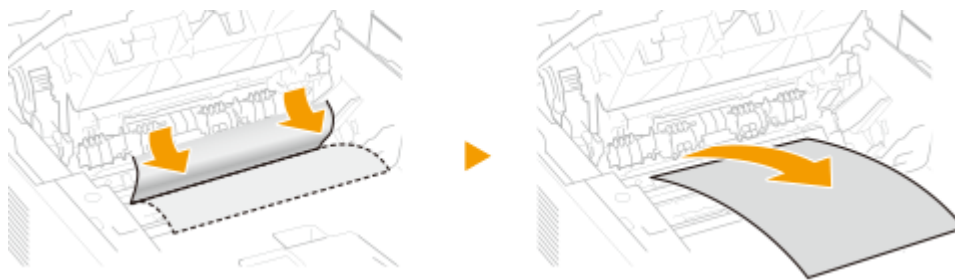

## **7** Check whether paper is jammed in the back cover.

**1** Open the back cover.

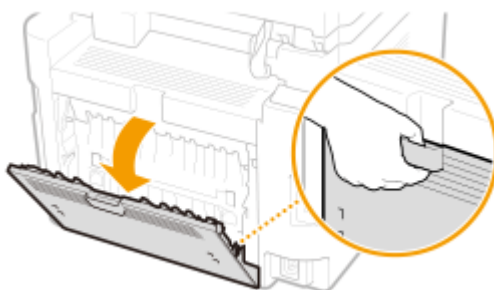

**2** Gently pull out the paper.

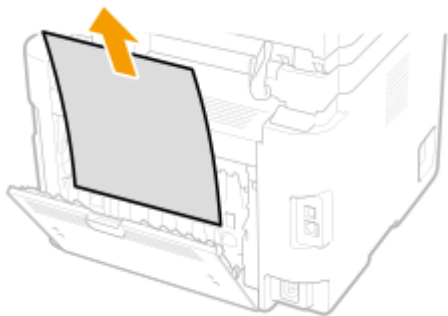

**3** Close the back cover.

## **8** Insert the cartridges.

**1** Insert the drum cartridge.

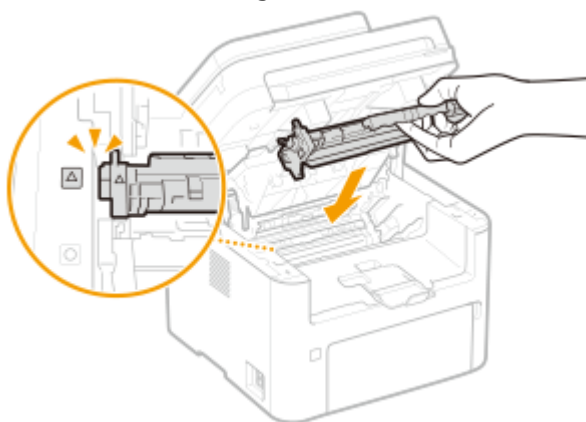

**2** Insert the toner cartridge.

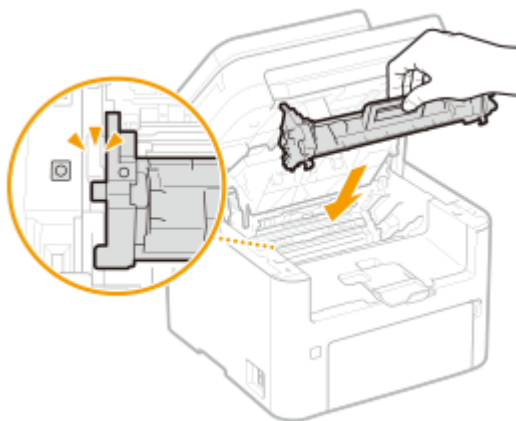

## **9** Close the toner cover, and lower the operation panel.

⇒ The paper jam message disappears, and the machine is ready to print.

## When a Problem Cannot Be Solved

2KUU-094

If you cannot solve a problem by referring to the information in this chapter, contact your local authorized Canon dealer or the Canon help line.

### IMPORTANT

#### Do not disassemble or repair the machine yourself

- If you disassemble or repair the machine yourself, it may not be covered by warranty.

#### Customer Support (U.S.A.)

If you cannot solve a problem by referring to the information in this chapter, contact the Canon Customer Care Center at 1-800-OK-CANON, Monday through Friday, between 8:00 A.M. and 8:00 P.M. EST. On-line support is available 24 hours a day at <http://www.canontechsupport.com>.

#### Customer Support (Canada)

Canon Canada Inc., offers a full range of customer technical support options\*:

- To perform step-by-step troubleshooting, send an e-mail to technical support, download drivers or support documents, or view answers to frequently asked questions, visit <http://www.canon.ca/>.
- Free live technical support is available from 9 A.M. to 8 P.M. EST, Monday through Friday (excluding holidays), for products still under warranty 1-800-OK-CANON.
- To find the location of the authorized service facility nearest you, visit <http://www.canon.ca/> or call 1-800-OK-CANON.
- If the problem cannot be corrected via these technical support options, repair options are available from the technical support personnel via the Web site at <http://www.canon.ca/>.

\*Available support options are subject to change without notice.

### ■ When Contacting Canon

When contacting us, have the following information ready:

- Product name (MF269dw / MF267dw / MF264dw)
- Dealer where you purchased the machine
- Details about your problem (such as what you did and what happened as a result)
- Serial number (found on the label on the back side of the machine)

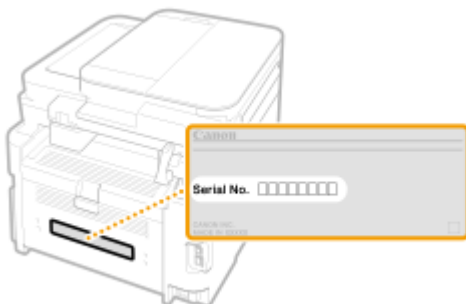

## NOTE

### Checking the serial number from the operation panel

- Press  ▶ <Device Information> ▶ <Serial Number>.

# Appendix

<b>Appendix</b> .....	521
<b>Third Party Software</b> .....	522
<b>Feature Highlights</b> .....	523
Going Green and Saving Money .....	524
Improving Efficiency .....	526
Going Digital .....	528
So Much More .....	530
<b>Specifications</b> .....	532
Main Unit .....	533
Feeder .....	536
Available Paper .....	538
Fax Function .....	541
Scan Function .....	542
Printer Functions .....	543
Management Functions .....	545
System Environment .....	546
Network Environment .....	548
<b>Manuals and Their Contents</b> .....	549
<b>Using User's Guide</b> .....	550
Screen Layout of User's Guide .....	551
Viewing User's Guide .....	554
<b>Basic Windows Operations</b> .....	556
<b>Menu Route Map</b> .....	564
<b>Notice</b> .....	565

# Appendix

---

2KUU-095

This chapter contains technical specifications of this machine, instructions on how to use the User's Guide, disclaimers, copyright information, and other important information for customers.

## ■ Machine Specifications

See the following section(s) when you want to check the specifications of the machine, network environment, print function, and so on.



▶ **Specifications(P. 532)**

## ■ Referencing the Manual of This Machine

See the first of the following sections when you want to be sure of the kinds of the manuals describing the functions of the machine and how to operate the machine. When you want to know how to read and use the User's Guide (this manual), see the second section.



▶ **Manuals and Their Contents(P. 549)**

▶ **Using User's Guide(P. 550)**

## ■ Others

See the following section(s) when you want to get useful information, and check the disclaimers and copyright information.



▶ **Third Party Software(P. 522)**

▶ **Feature Highlights(P. 523)**

▶ **Basic Windows Operations(P. 556)**

▶ **Menu Route Map(P. 564)**

▶ **Notice(P. 565)**



## Third Party Software

---

2KUU-096

For information related to third-party software, click the following icon(s).



## Feature Highlights

---

2KUU-097

This section describes tips for leveraging the features of the machine by category. You can make use of the features according to your intended purposes and operating environment.

- ▶ **Going Green and Saving Money(P. 524)**
- ▶ **Improving Efficiency(P. 526)**
- ▶ **Going Digital(P. 528)**
- ▶ **So Much More(P. 530)**

## Going Green and Saving Money

2KUU-098



There are lots of ways to cut back on paper, toner, power, and expenses.

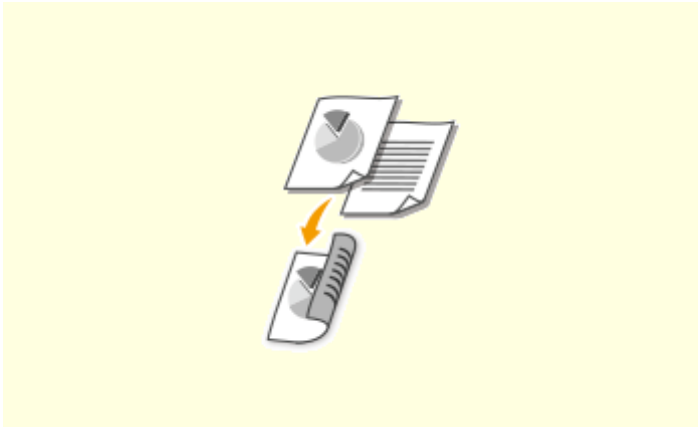

### 2-Sided Printing

You can use 2-sided printing for copies, print jobs sent from your computer, and even incoming faxes. Because you'll only be using half the paper you would otherwise, you can cut your paper costs in half. To save even more, combine 2-sided printing with N on 1 printing of multiple pages on one sheet of paper. You can print up to 32 pages on a single sheet, which is both economical and environmentally friendly.

- ▶ **Basic Copy Operations(P. 173)**
- ▶ **Printing from a Computer(P. 224)**
- ▶ **<Fax Settings>(P. 389)** ▶ **<RX Print Settings>** ▶ **<Print on Both Sides>**



### Print Multiple Pages on a Single Sheet

To really start saving paper, shrink multiple pages onto one side of a sheet - 2 or 4 pages for copies, and up to 16 pages for print jobs sent from your computer. This is even more effective when used together with 2-sided printing.

- ▶ **Copying Multiple Documents onto One Sheet (N on 1)(P. 185)**
- ▶ **Printing from a Computer(P. 224)**

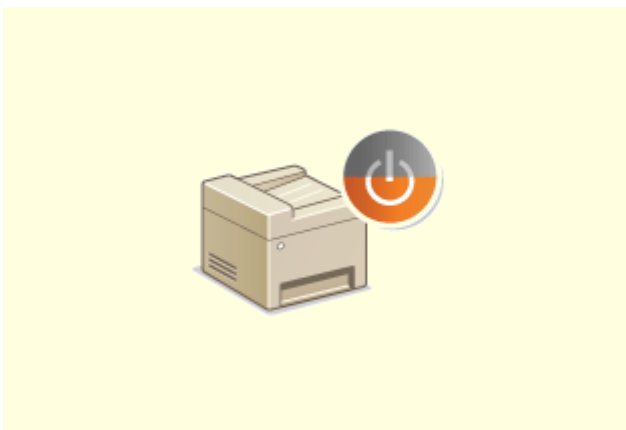

### Sleep Mode



### Paperless Faxing

For saving energy and money, a sleep mode that powers down a machine when nobody is using it has become an essential feature. This machine will enter sleep mode automatically, and can also be put to sleep whenever you want. Press  once to put the machine to sleep. Press it again to instantly wake the machine back into action.

▶ **Entering Sleep Mode(P. 159)**

Assume you need paper to fax? Those old paper printouts you always make are a thing of the past. Send documents by fax just as they are, created on your computer. It's paperless, so it's fast. And, received documents are first stored in memory, allowing you to print out only those needed and eliminating worry about paper getting used on direct mailings, etc.

▶ **Sending Faxes from Your Computer (PC Fax)(P. 219)**

▶ **Saving Received Documents into the Machine (Memory Reception)(P. 213)**

Canon strives to be environmentally and energy conscious in all aspects of its operations. Click [here](#) to learn about the ways in which Canon is helping to protect the environment.



## Improving Efficiency

2KUU-099



Here are some simple operations that can make complicated tasks more efficient.

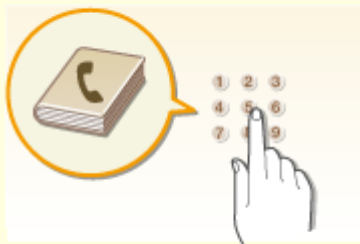



### Address Book

Entering fax and e-mail addresses in the Address Book saves you the inconvenience of entering them number-by-number, letter-by-letter every time you have something to send. Display the addresses you use most frequently with the <One-Touch> feature to quickly and easily send what you need to the people who need it. You can save your Address Book data on your computer and feel secure knowing that your important contact information is backed up.

- ▶ **Registering Destinations(P. 161)**
- ▶ **Registering Destinations from Remote UI(P. 347)**
- ▶ **Basic Operations for Sending Faxes(P. 195)**
- ▶ **Basic Operations for Scanning Originals(P. 233)**
- ▶ **Saving/Loading Address Book from Remote UI(P. 351)**



### Shortcut Keys for Copying and Scanning

Take advantage of the shortcut keys on the operation panel so you don't have to reconfigure the same settings over and over again. Use <Paper Save> (  ) to save paper by copying two or four pages onto one sheet. If you are using a machine capable of 2-sided printing, you can also copy on both sides of the sheet. For scanning, use <Scan -> PC1> (  ) or <Scan -> PC2> to preset your favorite save destinations, scan types, and file formats. Just place your originals and press the shortcut to scan.

- ▶ **Using <Paper Save Copy>(P. 187)**
- ▶ **Scanning Using the Shortcut Key(P. 236)**

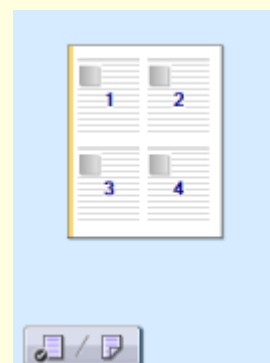

### **Remote Management with Remote UI**

Remote UI lets you manage a lot from your computer, all without having to go over to the machine. Configure settings and keep an eye on the machine's status with an intuitive, easy-to-understand Web browser interface that you'll master immediately. Save your time and energy for things other than taking care of the machine.

▶ **Managing the Machine from a Computer (Remote UI)**  
**(P. 334)**

### **Make Print Settings Quickly with Intuitive Operation**

You can easily specify the page layout as well as binding position, switching between 1-sided and 2-sided printing, etc. intuitively on the preview image in the printer driver. The simple click-operation allows you to conveniently make settings while viewing how settings are applied.

▶ **Printing from a Computer(P. 224)**

## Going Digital

2KUU-09A



Digitalizing a document enables editing using a computer as well as reducing cost and time by using e-mail.



### Scan and E-Mail

E-mail scanned originals without even turning on your computer. Just convert your scanned original into an e-mail attachment right from the machine. If you're one of those people who'd rather send a fax than mess around with a computer, this feature is for you.

▶ **Basic Operations for Scanning Originals(P. 233)**



### Scan and Share

Say you've got a paper copy of a report for a company-wide meeting. Scan it, convert it, and now everyone can see it. It's saved directly in a shared folder on your network, so there's no need to print out copies and pass them out. Once you start talking about hundreds of pages of documents that everyone needs, there's just no other way to go.

▶ **Basic Operations for Scanning Originals(P. 233)**



### Scan Only What You Need



### Searchable PDFs

What if you're scanning a whole page of a newspaper but all you're really interested in is a headline and a photo? Use ScanGear MF. You can select what you want from a preview, and then have the scanner disregard the rest. Otherwise you'll have to use an editing program to crop out everything you don't need.

▶ **Using ScanGear MF(P. 264)**

## IMPORTANT

- Using your product to scan, print or otherwise reproduce certain documents, and the use of such images as scanned, printed or otherwise reproduced by your product, may be prohibited by law and may result in criminal and/or civil liability. If you are uncertain about the legality of using your product to scan, print or otherwise reproduce any particular document, and/or of the use of the images scanned, printed or otherwise reproduced, you should consult in advance with your legal advisor for guidance.

Searching of text in a PDF can be done with a "searchable PDF." By scanning an original with both text and images, text portions are converted by OCR into text data. In addition to being able to search for text information, you can also copy required portions into an Excel spreadsheet or Word document in Microsoft Office. Eliminate the need to type in customer data, addresses, etc. from scratch.

▶ **Basic Operations for Scanning Originals(P. 233)**

▶ **Using Your Computer to Scan (Remote Scan) (P. 261)**



### Add Images to a Work in Progress

Some applications work with the machine to let you easily import scanned images directly into documents you're working on. This way you can skip the steps of opening a separate application just for receiving the scanned images and then exporting them to the application you're really using.

▶ **Scanning Documents from an Application(P. 262)**



## So Much More

2KUU-09C



There are a variety of features for whatever you need to do - at home, in the office, or even on the road.



### Using a smartphone/tablet

At times such as when you want to quickly print out a proposal you completed on a tablet while travelling to a business destination, Canon PRINT Business comes in handy. Even in environments without a wireless LAN router, you can connect to the machine with a mobile device wirelessly and directly.

PCless, quick, and easy! An even broader range of possibilities for work/play with functionality made for this age of speed.

▶ **Linking with Mobile Devices(P. 266)**



### Easy Printing with Google Cloud Print

Hook up to Google Cloud Print with your laptop or cell phone, send your data, and out come your printed documents. With this machine, Google Cloud Print, and your mobile device, print whenever you want from wherever you want.

▶ **Using Google Cloud Print(P. 286)**



### Go Wireless



### Get Faxes Wherever You Go

No cables, easy installation, simple maintenance. If you've got a WPS wireless LAN router, bypass the settings process altogether and be ready to go before you know it. Enjoy the kind of clutter-free and easy to use document system that you can only get from wireless. Compatible with IEEE 802.11b/g/n for stress-free wireless, and also supports WEP and WPA/WPA2-PSK (TKIP/AES-CCMP) for tighter security.

▶ **Connecting to a Wireless LAN(P. 18)**

Never worry about missing a fax when you're out of the office. Set a forwarding destination and any fax that comes in on the machine will go right to you. Better yet, make the forwarding destination the e-mail address for your tablet or mobile.

▶ **Forwarding the Received Documents Automatically(P. 215)**

# Specifications

---

2KUU-09E

Specifications are subject to change without notice for product improvement or future release.

## ■ Machine Specifications

- ▶ Main Unit(P. 533)
- ▶ Feeder(P. 536)
- ▶ Available Paper(P. 538)

## ■ Functional Specifications

- ▶ Fax Function(P. 541)
- ▶ Scan Function(P. 542)
- ▶ Printer Functions(P. 543)
- ▶ Management Functions(P. 545)

## ■ Environment To Use the Machine

- ▶ System Environment(P. 546)
- ▶ Network Environment(P. 548)

# Main Unit

2KUU-09F

## NOTE

- For information on paper sizes and types for each paper source, see " [▶ Available Paper\(P. 538\)](#) . "

<b>Name</b>	Canon imageCLASS MF269dw / MF267dw / MF264dw
<b>Type</b>	Desktop
<b>Color Supported</b>	Black and White
<b>Resolution for Reading</b>	600 dpi x 600 dpi
<b>Resolution for Writing</b>	600 dpi x 600 dpi
<b>Number of Tones</b>	256
<b>Acceptable Originals</b>	Up to 8 1/2" x 11 3/4" (215.9 mm x 297.0 mm) Maximum thickness of original: 1 5/8" (40 mm)
<b>Copy Size/Copy Paper</b>	<p><b>Paper Sizes</b></p> <ul style="list-style-type: none"> <li>Max: 8 1/2" x 14" (215.9 mm x 355.6 mm)*<sup>1</sup></li> <li>Min: 3" x 5" (76.2 mm x 127 mm)*<sup>1</sup></li> </ul> <p><b>Margin</b></p> <p><b>Top:</b></p> <ul style="list-style-type: none"> <li>When copying via the platen glass 1/4" ± 1/8" (5 mm ± 2.0 mm)</li> <li>When copying via the feeder 1/4" ± 1/8" (5 mm ± 3.0 mm)</li> </ul> <p><b>Left or Right:</b></p> <ul style="list-style-type: none"> <li>When copying via the platen glass 1/4" ± 1/8" (5 mm ± 2.0 mm)</li> <li>When copying via the feeder 1/4" ± 1/8" (5 mm ± 3.0 mm)</li> </ul> <p><b>Paper Weight</b></p> <ul style="list-style-type: none"> <li>16 lb Bond to 60 lb Cover (60 g/m<sup>2</sup> to 163 g/m<sup>2</sup>)</li> </ul>
<b>Paper Type</b>	<a href="#">▶ Available Paper(P. 538)</a>
<b>Warm-Up Time</b> * <sup>2</sup>	<p><b>After Powering ON</b></p> <p>15.0 seconds or less</p> <p><b>Returning from the Sleep mode</b></p>

Appendix

	1.6 seconds or less
<b>First Copy Time</b> (Letter)	Approx. 8.0 seconds
<b>Copy Speed</b> *3 (Letter)	30.0 sheets/minute
<b>Scanning Speed</b> (Letter)	2.5 seconds or less (300 dpi x 600 dpi)
<b>Magnification</b>	25 % to 400 % (in 1 % increments)
<b>Paper Feeding System/Capacity</b> *4	<b>Drawer</b> 250 sheets (21 lb Bond (80 g/m <sup>2</sup> ))/250 sheets (17 lb Bond (64 g/m <sup>2</sup> )) <b>Multi-Purpose Tray</b> 1 sheet (21 lb Bond (80 g/m <sup>2</sup> ))/1 sheet (17 lb Bond (64 g/m <sup>2</sup> ))
<b>Paper Output System/Capacity</b> *4	100 sheets (18 lb Bond (68 g/m <sup>2</sup> ))
<b>Multiple Copies</b>	999 sheets
<b>Power Source</b>	AC 120 V - 127 V, 3.9 A, 60 Hz
Power Consumption *2	<b>Maximum Power Consumption</b> 1,080 W or less <b>During Sleep Mode</b> <ul style="list-style-type: none"> <li>● Approx. 0.7 W (USB connection)</li> <li>● Approx. 0.7 W (wired LAN connection)</li> <li>● Approx. 0.7 W (wireless LAN connection)</li> </ul> <b>With the Main Power Turned OFF</b> 0.5 W or less
<b>Dimensions</b> (W x D x H)	<b>MF269dw:</b> 15 3/8" x 16" x 14 3/4" (390 mm x 405 mm x 375 mm) <b>MF267dw:</b> 15 3/8" x 16" x 14 3/4" (390 mm x 405 mm x 375 mm) <b>MF264dw:</b> 15 3/8" x 16" x 14 3/4" (390 mm x 405 mm x 375 mm)
<b>Weight</b>	<b>MF269dw:</b> <b>Main Unit</b> *5 Approx. 29.3 lb (13.3 kg) <b>Consumables</b>

	<p>➤ <b>Consumables(P. 460)</b>  <b>MF267dw / MF264dw:</b></p> <p><b>Main Unit</b> *5  Approx. 27.3 lb (12.4 kg)</p> <p><b>Consumables</b></p> <p>➤ <b>Consumables(P. 460)</b></p>
<b>Installation Space</b>	<p>See "Getting Started"</p> <p>➤ <b>Manuals and Their Contents(P. 549)</b></p>
<b>Memory Capacity</b>	<b>RAM:</b> 256 MB
<b>Environmental Conditions</b>	<p>Temperature: 50°F to 86°F (10°C to 30°C)</p> <p>Humidity: 20 % to 80 % RH (no condensation)</p>

\*1Including multi-purpose tray

\*2May vary depending on the environment and conditions under which the machine is being used.

\*3Copy/print speeds are measured based on internal testing using Letter size paper copied/printed with 100% copy/print ratio to original on one-sided paper. Internal testing involved continuously copying/printing the same one page of content on plain paper (copy speed is tested by copying on the platen glass). Copy/print speeds may vary depending on paper type, paper size or paper feeding direction.

The device may automatically pause or slow down in order to adjust printer condition such as controlling temperature of a certain unit or limiting impact to image quality during continuous copying/printing.

\*4May vary depending on the installation environment and paper to use.

\*5The toner cartridge and the drum cartridge are not included.

# Feeder

2KUU-09H

<b>Original Feeding Mechanism</b>	<b>MF269dw:</b> Automatic 2-Sided Document Feeder <b>MF267dw / MF264dw:</b> Automatic 1-Sided Document Feeder
<b>Original Size <sup>*1</sup> /Type</b>	<b>MF269dw:</b> <b>Size of Originals</b> <ul style="list-style-type: none"> <li>• <b>Max :</b> 8 1/2" x 14" (216 mm x 356 mm)</li> <li>• <b>Min :</b> 5 1/2" x 5" (140 mm x 127 mm)</li> </ul> <b>Weight of Originals</b> <ul style="list-style-type: none"> <li>• <b>1-Sided Originals:</b> 13 lb Bond to 27.9 lb Bond (50 g/m<sup>2</sup> to 105 g/m<sup>2</sup>) (1 Sheet: 13 lb Bond to 47 lb Cover (50 g/m<sup>2</sup> to 128 g/m<sup>2</sup>))</li> <li>• <b>2-Sided Originals:</b> 16 lb Bond to 27.9 lb Bond (60 g/m<sup>2</sup> to 105 g/m<sup>2</sup>)</li> </ul> <b>MF267dw / MF264dw:</b> <b>Size of Originals</b> <ul style="list-style-type: none"> <li>• <b>Max:</b> 8 1/2" x 14" (216 mm x 356 mm)</li> <li>• <b>Min:</b> 5 7/8" x 4 1/8" (148 mm x 105 mm)</li> </ul> <b>Weight of Originals</b> <ul style="list-style-type: none"> <li>• <b>1-Sided Originals:</b> 13 lb Bond to 27.9 lb Bond (50 g/m<sup>2</sup> to 105 g/m<sup>2</sup>) (1 Sheet: 13 lb Bond to 47 lb Cover (50 g/m<sup>2</sup> to 128 g/m<sup>2</sup>))</li> </ul>
<b>Original Tray Capacity</b>  (Letter)	<b>MF269dw:</b> 50 sheets (21 lb Bond (80 g/m <sup>2</sup> )) <b>MF267dw / MF264dw:</b> 35 sheets (21 lb Bond (80 g/m <sup>2</sup> ))
<b>Original Scanning Speed</b>	<b>MF269dw:</b> <b>Copying (300 dpi x 600 dpi, Letter)</b> <b>1-Sided Scanning:</b> 23.0 pages/minute <b>2-Sided Scanning:</b> 8.0 pages/minute <b>Scanning (300 dpi x 600 dpi, Letter) *2</b> <b>1-Sided Scanning:</b> <ul style="list-style-type: none"> <li>• <b>Full Color (PDF):</b> 7.7 pages/minute</li> <li>• <b>Black and White (TIFF):</b> 11.6 pages/minute</li> </ul> <b>2-Sided Scanning:</b> <ul style="list-style-type: none"> <li>• <b>Full Color (PDF):</b> 2.4 pages/minute</li> <li>• <b>Black and White (TIFF):</b> 4.0 pages/minute</li> </ul> <b>MF267dw / MF264dw:</b>

	<p><b>Copying (300 dpi x 600 dpi, Letter)</b></p> <p>21.0 pages/minute</p> <p><b>Scanning (300 dpi x 600 dpi, Letter) *2</b></p> <ul style="list-style-type: none"><li>● <b>Full Color (PDF):</b> 8.0 pages/minute</li><li>● <b>Black and White (TIFF):</b> 10.6 pages/minute</li></ul>
--	---

\*1To maintain the optimum image quality, it is recommended to scan A6 size original(s) from the platen glass.

\*2May vary depending on the environment and conditions under which the machine is being used.



## Available Paper

2KUU-09J

The paper types that can be used with this machine are shown in the following table.

### ■ Supported Paper Sizes

✓ : Available    — : Unavailable

Paper Sizes	Drawer	Multi-Purpose Tray	Automatic 2-Sided Printing <sup>*1</sup>
A4 <sup>*2</sup>	✓	✓	✓
B5	✓	✓	—
A5 <sup>*3</sup>	✓	✓	—
A6 <sup>*4</sup>	✓	✓	—
Legal	✓	✓	✓
Letter <sup>*2</sup>	✓	✓	✓
Statement	✓	✓	—
Executive	✓	✓	—
Oficio	✓	✓	✓
Oficio (Brazil)	✓	✓	✓
Oficio (Mexico)	✓	✓	✓
Letter (Government)	✓	✓	—
Legal (Government)	✓	✓	—
Foolscap	✓	✓	✓
Foolscap (Australia)	✓	✓	—
Legal (India)	✓	✓	✓
3x5inch	✓	✓	—

Paper Sizes	Drawer	Multi-Purpose Tray	Automatic 2-Sided Printing <sup>*1</sup>
F4A	✓	✓	✓
Envelope No. 10 (COM10)	✓	✓	—
Envelope Monarch	✓	✓	—
Envelope C5	✓	✓	—
Envelope DL	✓	✓	—
Custom	✓ <sup>*5</sup>	✓ <sup>*5</sup>	—

<sup>\*1</sup>Automatic 2-sided printing is available without replacing paper.

<sup>\*2</sup>Allows you to print received fax documents.

<sup>\*3</sup>If feeding in landscape orientation, can be specified only from the printer driver.

<sup>\*4</sup>Available only from the printer driver.

<sup>\*5</sup>The custom size ranging from 3" x 5" (76.2 x 127.0 mm) to 8 1/2" x 14" (215.9 x 355.6 mm) is available.

## ■ Supported Paper Types

Chlorine-free paper can be used with this machine.

✓ : Available — : Unavailable

Paper Type		Drawer	Multi-Purpose Tray	Automatic 2-Sided Printing <sup>*1</sup>
Plain	19 to 23 lb Bond (71 to 89 g/m <sup>2</sup> )	✓	✓	✓ <sup>*2</sup>
Plain L	17 to 18 lb Bond (61 to 70 g/m <sup>2</sup> )	✓	✓	✓ <sup>*2</sup>
Plain L2	16 lb Bond (60 g/m <sup>2</sup> )	✓	✓	✓ <sup>*2</sup>
Heavy 1	24 to 28 lb Bond (90 to 105 g/m <sup>2</sup> )	✓	✓	✓ <sup>*2</sup>
Heavy 2	29 to 32 lb Bond (106 to 120 g/m <sup>2</sup> )	✓	✓	—
Heavy 3	33 to 60 lb Cover (121 to 163 g/m <sup>2</sup> )	✓	✓	—
Heavy 4 <sup>*3</sup>	33 to 60 lb Cover (121 to 163 g/m <sup>2</sup> )	✓	✓	—
Recycled	19 to 23 lb Bond (71 to 89 g/m <sup>2</sup> )	✓	✓	✓ <sup>*2</sup>
Bond 1	16 to 27 lb Bond (60 to 104 g/m <sup>2</sup> )	✓	✓	✓ <sup>*2</sup>

Appendix

Paper Type		Drawer	Multi-Purpose Tray	Automatic 2-Sided Printing <sup>*1</sup>
<b>Bond 2</b>	28 lb Bond to 60 lb Cover (105 to 163 g/m <sup>2</sup> )	✓	✓	—
<b>Index Card</b>	33 to 60 lb Cover (121 to 163 g/m <sup>2</sup> )	✓	✓	—
<b>Labels</b>		✓	✓	—
<b>Envelope</b>		✓	✓	—
<b>Envelope H <sup>*4</sup></b>		✓	✓	—

<sup>\*1</sup>Automatic 2-sided printing is available without replacing paper.

<sup>\*2</sup>Usable paper sizes are A4, Legal, Letter, Oficio, Oficio (Brazil), Oficio (Mexico), Legal (India), Foolscap/Folio, and F4A.

<sup>\*3</sup>When using paper of 33 to 60 lb Cover (121 to 163 g/m<sup>2</sup>) with <Heavy 3> specified, select this paper type if toner is not fully fixed and the printouts are faded.

<sup>\*4</sup>Select this paper type if toner is not fully fixed and the printouts are faded when the paper type is set to <Envelope>.

# Fax Function

2KUU-09K

<b>Telephone Line Used</b> *1	Public Switched Telephone Network (PSTN)
<b>Scan Line Density</b>	<p><b>Normal</b></p> <p><b>G3:</b> 8 pels<sup>*2</sup>/mm x 3.85 line/mm</p> <p><b>Fine</b></p> <p><b>G3:</b> 8 pels<sup>*2</sup>/mm x 7.7 line/mm</p> <p><b>Superfine</b></p> <p><b>G3:</b> 8 pels<sup>*2</sup>/mm x 15.4 line/mm</p>
<b>Transmission Speed</b> *3	<p><b>Super G3:</b> 33.6 kbps</p> <p><b>G3:</b> 14.4 kbps</p>
<b>Compression Method</b>	MH, MR, MMR
<b>Transmission Type</b>	Super G3, G3
<b>Max. Sending Original Sizes</b>	Letter
<b>Receiving Paper Sizes</b>	🔴 <b>Available Paper(P. 538)</b>
<b>Transmission Times</b>	Approx. 3.0 seconds/page <sup>*4</sup>

\*1 Depending on your locale or your telephone connection, you may be unable to perform data communication. In this case, contact your local authorized Canon dealer or the Canon help line.

\*2 Pels stands for picture elements (pixels).

\*3 With the Automatic Fallback function.

\*4 Based on ITU-T (ITU Telecommunication Standardization Sector) Standard Chart No. 1, JBIG standard mode.

# Scan Function

2KUU-09L

<b>Type</b>	Color Scanner
<b>Original Scanning Size (Max)</b>	<p><b>Scanning on Platen Glass</b></p> <p>Same as "Acceptable Originals" in "Main Unit"</p> <p>▶ <b>Main Unit(P. 533)</b></p> <p><b>Scanning from Feeder</b></p> <p>Same as "Size of Originals" in "Feeder"</p> <p>▶ <b>Feeder(P. 536)</b></p>
<b>Resolution (Max)</b>	600 dpi x 600 dpi
<b>Scanning Speed</b>	<p><b>Scanning on Platen Glass</b></p> <p>Same as "Scanning Speed" in "Main Unit"</p> <p>▶ <b>Main Unit(P. 533)</b></p> <p><b>Scanning from Feeder</b></p> <p>Same as "Original Scanning Speed" in "Feeder"</p> <p>▶ <b>Feeder(P. 536)</b></p>
<b>Interface</b>	<p><b>USB</b></p> <p>USB 1.1 Full-Speed, USB 2.0 Hi-Speed</p> <p><b>Wired LAN</b></p> <p>10BASE-T, 100BASE-TX (IEEE 802.3 compliant)</p> <p><b>Wireless LAN</b></p> <p>IEEE 802.11b, IEEE 802.11g, IEEE 802.11n</p>
<b>Protocol Supported *</b>	SMB (TCP/IP), SMTP, TCP/IP, USB
<b>Output Format (Push Scan)</b>	TIFF (MMR), JPEG (Single-Page), PDF

\* Some formats are not supported depending on the function.

## Printer Functions

2KUU-09R

### ■ UFR II-LT Printer Function

Type	Internal
Print Size	▶ <b>Available Paper(P. 538)</b>
Print Speed	Same as "Copy Speed" in "Main Unit" ▶ <b>Main Unit(P. 533)</b>
Resolution	<b>Data Processing</b> 1200 dpi x 1200 dpi, 600 dpi x 600 dpi
Page Description Language (PDL)	UFR II-LT
Protocol Supported	TCP/IP: LPD, Port9100, IPP, IPPS, WSD
Resident Fonts	None
Interface	<b>USB</b> USB 1.1 Full-Speed, USB 2.0 Hi-Speed <b>Wired LAN</b> 10BASE-T, 100BASE-TX (IEEE 802.3 compliant) <b>Wireless LAN</b> IEEE 802.11b, IEEE 802.11g, IEEE 802.11n

### ■ PCL Printer Function

Type	Internal
Print Size	▶ <b>Available Paper(P. 538)</b>
Print Speed	Same as "Copy Speed" in "Main Unit" ▶ <b>Main Unit(P. 533)</b>
Resolution	<b>Data Processing</b> 1200 dpi x 1200 dpi, 600 dpi x 600 dpi
Page Description Language (PDL)	PCL6, PCL5e
Protocol Supported	TCP/IP: LPD, Port9100, IPP, IPPS, WSD

## Appendix

<b>Resident Fonts</b>	45 Roman
<b>Interface</b>	<b>USB</b> USB 1.1 Full-Speed, USB 2.0 Hi-Speed <b>Wired LAN</b> 10BASE-T, 100BASE-TX (IEEE 802.3 compliant) <b>Wireless LAN</b> IEEE 802.11b, IEEE 802.11g, IEEE 802.11n

# Management Functions

2KUU-09S

## ■ Firewall Settings

- Up to 4 IP addresses (or ranges of IP addresses) can be specified for both IPv4 and IPv6.
- Up to 10 MAC addresses can be specified.

## ■ Registration of Keys and Certificates

- If you install a key or CA certificate from a computer, make sure that they meet the following requirements:

<b>Format</b>	<ul style="list-style-type: none"> <li>• Key: PKCS#12<sup>*1</sup></li> <li>• CA certificate: X.509 DER/PEM</li> </ul>
<b>File extension</b>	<ul style="list-style-type: none"> <li>• Key: ".p12", ".pfx"</li> <li>• CA certificate: ".cer"</li> </ul>
<b>Public key algorithm (and key length)</b>	<ul style="list-style-type: none"> <li>• RSA (512 bits<sup>*2</sup>, 1024 bits, 2048 bits, 4096 bits)</li> <li>• ECDSA (P256, P384, P521)</li> </ul>
<b>Certificate signature algorithm</b>	<ul style="list-style-type: none"> <li>• RSA: SHA1<sup>*3</sup>, SHA256, SHA384<sup>*4</sup>, SHA512<sup>*4</sup>, MD2<sup>*5</sup>, MD5<sup>*5</sup></li> <li>• ECDSA: SHA1<sup>*3</sup>, SHA256, SHA384, SHA512</li> </ul>

<sup>\*1</sup>Requirements for the certificate contained in a key are pursuant to CA certificates.

<sup>\*2</sup>The signature algorithm is available only for SHA1-RSA or SHA256-RSA.

<sup>\*3</sup>Available only for a generated key and certificate signature request (CSR) or installation from the Remote UI.

<sup>\*4</sup>Available only when the key algorithm is 1024 bits or more.

<sup>\*5</sup>Available only for installation from the Remote UI.

## NOTE

- The machine does not support use of a certificate revocation list (CRL).



# System Environment

2KUU-09U

<b>System Environment for WSD Scan</b>	<ul style="list-style-type: none"> <li>• Windows Vista</li> <li>• Windows 7</li> <li>• Windows 8.1</li> <li>• Windows 10</li> </ul>
<b>System Requirements for the Remote UI <sup>*1</sup></b>	<p><b>Windows</b></p> <ul style="list-style-type: none"> <li>• Windows Vista / 7 / 8.1 / 10: Internet Explorer 11 or later</li> <li>• Windows 10: Edge</li> </ul> <p><b>macOS</b></p> <ul style="list-style-type: none"> <li>• Mac OS X 10.6 and later</li> <li>• Safari 3.2.1 and later</li> </ul> <p><b>iOS</b></p> <ul style="list-style-type: none"> <li>• Safari</li> </ul> <p><b>Android</b></p> <ul style="list-style-type: none"> <li>• Chrome</li> </ul>
<b>File Servers Available as Destinations for File Transmission</b>	<p><b>SMB</b></p> <ul style="list-style-type: none"> <li>• Windows Vista SP2 / 7 / 8 / 8.1 / 10</li> <li>• Windows Server 2008 / Server 2012</li> <li>• Solaris Version 2.6 and later</li> <li>• Red Hat Linux 7.2 and later</li> <li>• Mac OS X 10.6 and later</li> </ul> <p><b>SMTP</b></p> <ul style="list-style-type: none"> <li>• Sendmail 8.12.5 and later</li> <li>• Sendmail 8.13.x</li> <li>• Sendmail 8.14.x</li> <li>• Exchange Server 2003 / 2007 / 2010</li> <li>• Lotus Domino 6.x / 7.x / 8.x</li> </ul>
<b>System Requirements for the Send Function Setting Tool</b>	<ul style="list-style-type: none"> <li>• Windows 7 / 8.1 / 10 / Server 2003 / Server 2008: Internet Explorer 7 or later</li> <li>• Windows 10: Edge</li> </ul>
<b>System Requirements for the User's Guide</b>	<p><b>Windows</b></p> <ul style="list-style-type: none"> <li>• Internet Explorer 9 and later</li> <li>• Microsoft Edge</li> <li>• Firefox</li> <li>• Firefox ESR</li> <li>• Chrome<sup>*2</sup></li> </ul> <p><b>macOS</b></p> <ul style="list-style-type: none"> <li>• Safari</li> <li>• Firefox</li> <li>• Chrome<sup>*2</sup></li> </ul>

	<p><b>Linux</b></p> <ul style="list-style-type: none"><li>• Firefox</li></ul> <p><b>iOS</b></p> <ul style="list-style-type: none"><li>• Safari*<sup>2</sup></li></ul> <p><b>Android</b></p> <ul style="list-style-type: none"><li>• Chrome*<sup>2</sup></li></ul>
--	---

\*<sup>1</sup>Before changing the settings of the machine, set your Web browser to enable all cookies and use JavaScript.

\*<sup>2</sup>Only when viewing manuals on the Internet

# Network Environment

2KUU-09W

## ■ Common Specifications

<b>Protocol Supported</b>	<b>TCP/IP</b> <ul style="list-style-type: none"> <li>● <b>Frame type:</b> Ethernet II</li> <li>● <b>Print applications:</b> LPD, Raw, IPP, IPPS, WSD, Mopria, Google Cloud Print, AirPrint, Windows10 Mobile Print</li> </ul>
---------------------------	---

## ■ Wired LAN Specifications

<b>Interface</b>	10BASE-T, 100BASE-TX (RJ-45)
------------------	------------------------------





## ■ Wireless LAN Specifications

<b>Standard</b>	IEEE 802.11b, IEEE 802.11g, IEEE 802.11n
<b>Transmission Scheme</b>	IEEE 802.11b (Modulation system: DS-SS) IEEE 802.11g (Modulation system: OFDM method) IEEE 802.11n (Modulation system: OFDM method)
<b>Frequency Range</b>	2.412 GHz to 2.462 GHz
<b>Maximum Radio-Frequency Power Transmitted</b>	15.9 dBm
<b>Communication Mode</b>	<ul style="list-style-type: none"> <li>● Infrastructure Mode</li> <li>● Access Point Mode</li> </ul>
<b>Security (encryption method)</b>	<b>Infrastructure Mode</b> <ul style="list-style-type: none"> <li>● 128 (104)/64 (40) bit WEP</li> <li>● WPA-PSK (TKIP/AES-CCMP)</li> <li>● WPA2-PSK (TKIP/AES-CCMP)</li> </ul> <b>Access Point Mode</b> WPA2-PSK (AES-CCMP)
<b>Connection Method</b>	WPS (Wi-Fi Protected Setup), Manual setup

## Manuals and Their Contents

2KUU-09X

The manuals listed below are included with the machine. Refer to them as necessary.

<b>Getting Started</b>		<p>Read this manual first. It describes basic setup procedures, from removing the packing materials to setting up the machine.</p> 
<b>User's Guide (This Manual)</b>		<p>This manual describes all the functions of the machine in a manual that is viewed using a Web browser. You can browse information by category or enter a keyword to search for pages on a specific topic.  <b>Using User's Guide(P. 550)</b></p>
<b>Send Setting Guide</b>		<p>This manual describes how to configure settings and prepare for sending scanned images by e-mail and saving scanned images to shared folders.</p>

# Using User's Guide

---

2KUU-09Y

The User's Guide is a manual that can be viewed on your computer or mobile device and it describes all of the functions of the machine. You can search from your intended use or enter a keyword to quickly find the page you are looking for. The section describes the screen layout of the User's Guide and how to read the Guide. You can specify how the appearance of the User's Guide looks.

## ■ Screen Layout of User's Guide

This section describes the screens configuring the User's Guide and how to use the on-screen buttons. [▶Screen Layout of User's Guide\(P. 551\)](#)

## ■ Viewing User's Guide

This section describes the meaning of the marks used in the User's Guide, how the keys on the operation panel and the buttons on the computer display are represented, and other matters that help you understand the information contained in the User's Guide. [▶Viewing User's Guide\(P. 554\)](#)

## ■ Specifying How the Appearance of the User's Guide Looks

You can change the character size used in the User's Guide, and switch the screen layout to fit to the device you use to view the User's Guide.

### NOTE

- If you do not have access to Adobe Reader to view the manuals in PDF format, try other programs such as PDF Preview developed by Vivid Document Imaging Technologies.

### How to Find the Topic You Are Looking for

#### Search the contents

- You can find the page you are looking for by selecting the topic from the "Contents" on the left side of the screen.

#### Search by keyword

- Perform a search by entering a keyword, such as "envelope" or "toner cartridge," and the pages containing the keyword are displayed. You can find the page you are looking for from those results. You can also enter phrases such as "connecting to a network." The keyword search also supports the AND Boolean to search for multiple keywords. For the organization of the search screen and how to operate the search screen, see [▶Search\(P. 553\)](#) .

# Screen Layout of User's Guide

2KUU-0A0

The User's Guide is divided into different screens, and the content of each screen varies.

## Top Page

Appears when User's Guide is started.

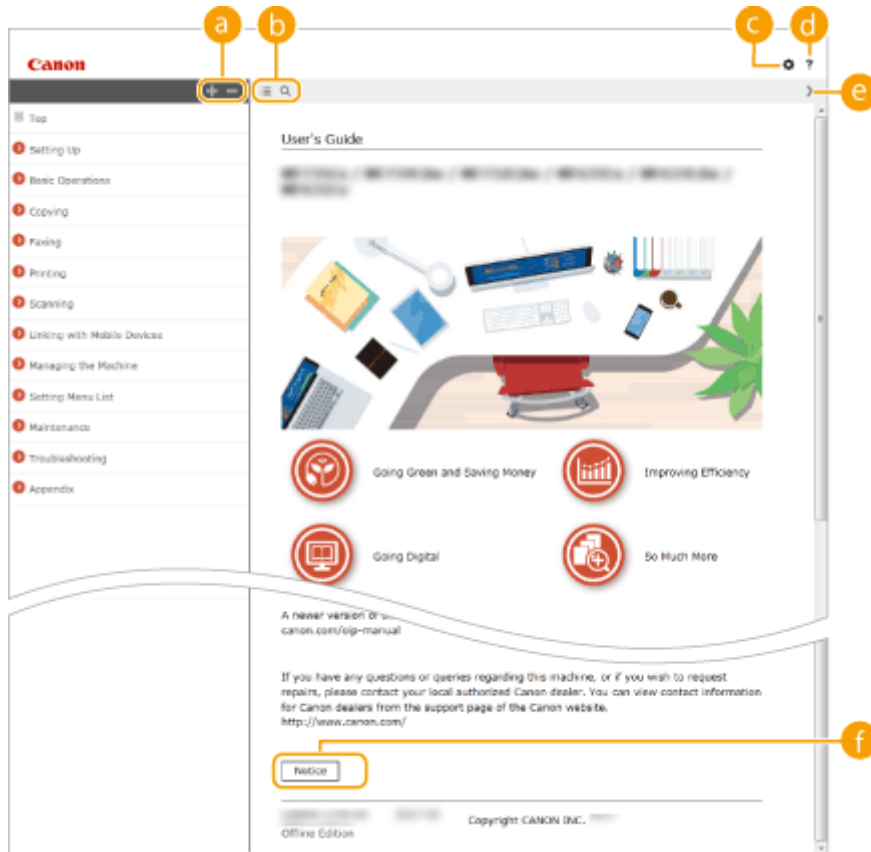

Click to also display all of the sections under the chapters. Click to return to the previous display.



Click to toggle the display between the contents and search. When the table of contents is displayed, each click on switches between hiding and showing the display. When the search display is shown, each click on switches between hiding and showing the display.



Click to set parameters to determine how the User's Guide is displayed, such as character size or layout.



Click to display information on how to view the User's Guide, how to perform a search, and other information.



Click to display the previous or following topic.



Click to view important information you should know when using the machine.

## Topic Page

Contains information about how to configure and use the machine.

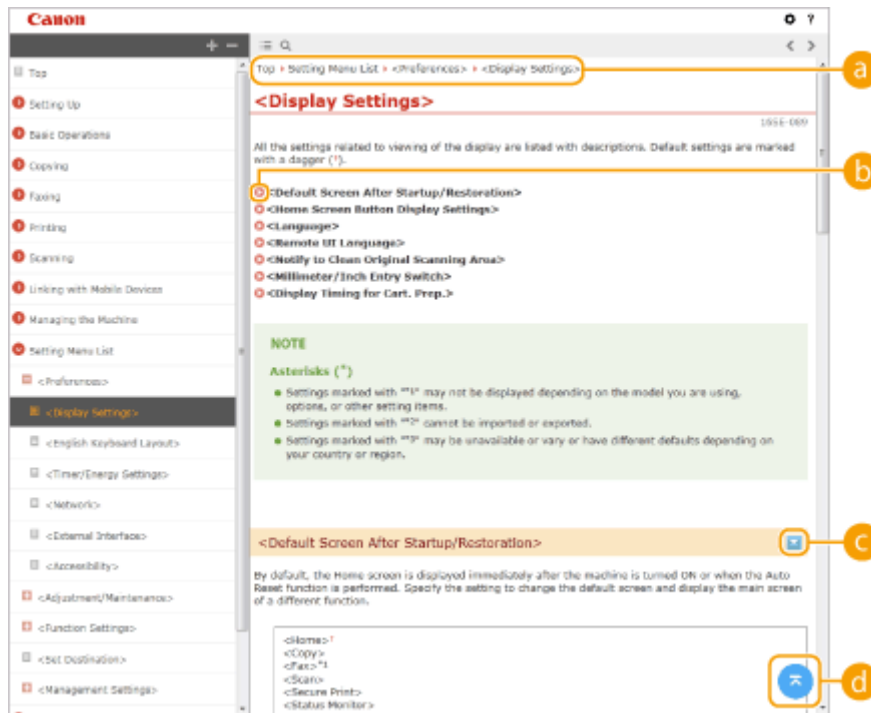

### a Navigation

See what chapter topic you are currently viewing.

### b

Click to jump to the corresponding page. To return to the previous page, click "Back" on your Web browser.

## NOTE:

- When you click the icon, the current page may go dark and a pop-up window may appear. To return to the page, click [Close] in the pop-up window.

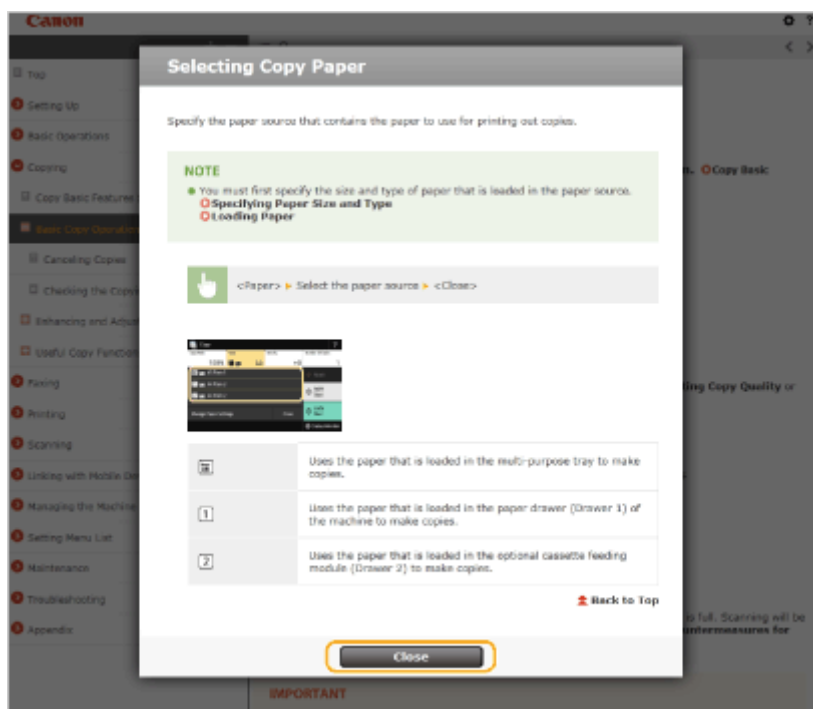



Click  to display the hidden detailed descriptions. Click  to close the detailed descriptions.



Click to return to the page top.

## Search

Click  to display the search window. Contains a text box to perform a search by keyword and find the page you are looking for.

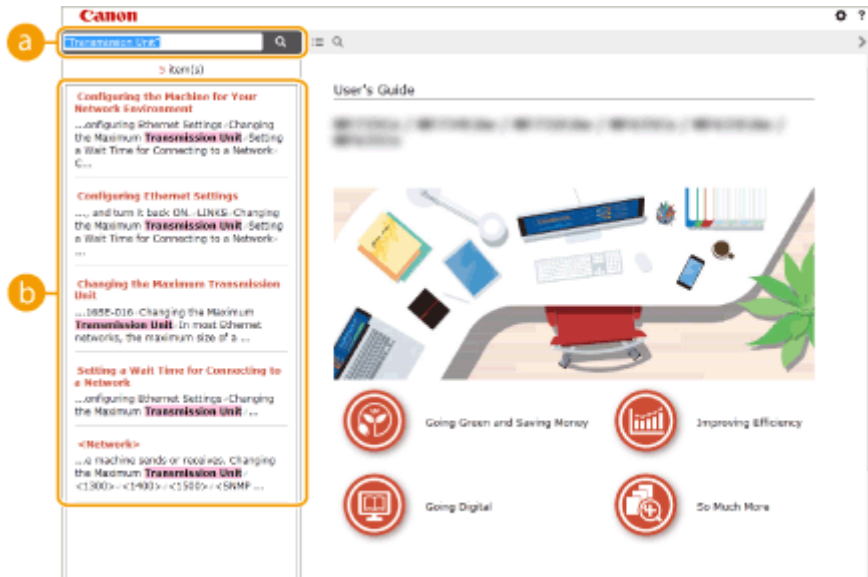

### a [Enter keyword(s) here]

Enter a keyword or keywords and click  to display the search results. You can search for pages containing all the keywords by separating the keywords by a space (blank). Also you can only search for pages containing an exact phrase by enclosing the keywords in double quotation marks.

### b Search result

Displays the search results of the pages that contain the specified keywords. From the results, locate the page you are looking for and click the topic title of the page.

## NOTE:

- The specified keyword(s) are shown in bold in the search results.



# Viewing User's Guide

2KUU-0A1

This section describes the marks, buttons, screens, and other items used in the User's Guide. The warnings and cautions are also given in the "Important Safety Instructions" in the "Getting Started" included with the machine. See also these instructions.

## Marks

Cautions regarding safety, restrictions and cautions regarding the handling of the machine, useful tips, and other information are indicated using the marks below.



Indicates an operation that must not be performed. Read these items carefully, and make sure not to perform the described operations.

## IMPORTANT

Indicates operational requirements and restrictions. Be sure to read these items carefully to operate the machine correctly, and avoid damage to the machine or property.

## NOTE



Indicates a clarification of an operation, or contains additional explanations for a procedure.

## TIPS

Indicates useful functions or tips for using the machine.

## Keys and Buttons Used in this Manual



Keys on the operation panel and buttons on the computer display appear in the following notation:

Type	Example
Keys on the operation panel	 
Settings displayed on the operation panel	<Timer Settings> <Paper jammed.>
Buttons and other text interfaces displayed on the computer display	[Preferences]

## NOTE

- A case in which a user taps a button on the display for the Touch Panel Model, and a case in which a user presses a key on the operation panel for the 5 Lines LCD Model are described even when their operations are the same. For example, the operation for displaying the <Menu> screen is represented by "Press <Menu> (.

## ▲ / ▼ / (5 Lines LCD Model)

▲, ▼, and  on the operation panel are used to select the target item in settings, but their description is omitted in the User's Guide. The operation for selecting <XXXXX> using ▲ or ▼ and pressing  is represented as shown below in the User's Guide.

- 1 Select <XXXXX>.

### **Computer Screens Used in This Manual**

---

Unless otherwise noted, displays used in the User's Guide are those for the MF269dw. Depending on the model or operating system you are using, the appearance of the displays used in this manual may slightly differ from the actual displays. Also, the appearance of drivers and software may differ depending on their version.

### **Illustrations Used in This Manual**

---

Unless otherwise noted, illustrations used in the User's Guide are those for the MF269dw. When differences are significant, multiple illustrations are used with the model names, such as "MFXXX / MFXXX." The illustrations of the toner cartridge are those for the Canon Toner Cartridge 051.

# Basic Windows Operations

2KUU-0A3

- ▶ **Displaying the Printer Folder(P. 556)**
- ▶ **Enabling [Network discovery](P. 556)**
- ▶ **Displaying Shared Printers in the Print Server(P. 557)**
- ▶ **Displaying the [Software Programs/Manuals Setup] Screen(P. 558)**
- ▶ **Printing a Test Page in Windows(P. 558)**
- ▶ **Checking the Bit Architecture(P. 559)**
- ▶ **Checking the Computer Name(P. 560)**
- ▶ **Checking the Printer Port(P. 561)**
- ▶ **Checking Bidirectional Communication(P. 562)**
- ▶ **Checking the SSID to Which Your Computer is Connected(P. 563)**
- ▶ **When Printing or Sending from the Windows Store App(P. 563)**

## NOTE

- Depending on the computer that you use, the operation may differ.

## ■ Displaying the Printer Folder

### Windows Vista

[Start] ▶ select [Control Panel] ▶ [Printer].

### Windows 7/Server 2008 R2

[Start] ▶ select [Devices and Printers].

### Windows 8/Server 2012

Right-click the lower-left corner of the screen ▶ select [Control Panel] ▶ [View devices and printers].

### Windows 8.1/Server 2012 R2

Right-click [Start] ▶ select [Control Panel] ▶ [View devices and printers].

### Windows 10

[

### Windows Server 2008

[Start] ▶ select [Control Panel] ▶ double-click [Printers].

### Windows Server 2016

Right-click [

## ■ Enabling [Network discovery]

Enable [Network discovery] to view the computers on your network.

### Windows Vista

[Start] ▶ select [Control Panel] ▶ [View network status and tasks] ▶ select [Turn on network discovery] under [Network discovery].

### Windows 7/Server 2008 R2

[Start] ▶ select [Control Panel] ▶ [View network status and tasks] ▶ [Change advanced sharing settings] ▶ select [Turn on network discovery] under [Network discovery].

### Windows 8/Server 2012

Right-click the lower-left corner of the screen ▶ select [Control Panel] ▶ [View network status and tasks] ▶ [Change advanced sharing settings] ▶ select [Turn on network discovery] under [Network discovery].

#### Windows 8.1/Server 2012 R2

Right-click [Start] ▶ select [Control Panel] ▶ [View network status and tasks] ▶ [Change advanced sharing settings] ▶ select [Turn on network discovery] under [Network discovery].

#### Windows 10

[Windows Key] ▶ select [Windows System] ▶ [Control Panel] ▶ [View network status and tasks] ▶ [Change advanced sharing settings] ▶ select [Turn on network discovery] under [Network discovery].

#### Windows Server 2008

[Start] ▶ select [Control Panel] ▶ double-click [Network and Sharing Center] ▶ select [Turn on network discovery] under [Network discovery].

#### Windows Server 2016

Right-click [Windows Key] ▶ select [Control Panel] ▶ [View network status and tasks] ▶ [Change advanced sharing settings] ▶ select [Turn on network discovery] under [Network discovery].

## ■ Displaying Shared Printers in the Print Server

### 1 Open Windows Explorer.

#### Windows Vista/7/Server 2008

[Start] ▶ select [All Programs] or [Programs] ▶ [Accessories] ▶ [Windows Explorer].

#### Windows 8/Server 2012

Right-click the lower-left corner of the screen ▶ select [File Explorer].

#### Windows 8.1/Server 2012 R2

Right-click [Start] ▶ select [File Explorer].

#### Windows 10/Server 2016

Right-click [Windows Key] ▶ select [File Explorer].

### 2 Select the printer server in [Network] or [My Network Places].

- To view computers on the network, you may need to turn on network discovery or search the network for computers.

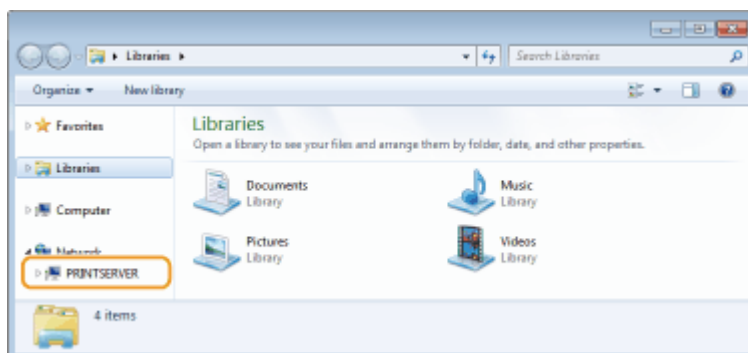

⇒ Shared printers are displayed.

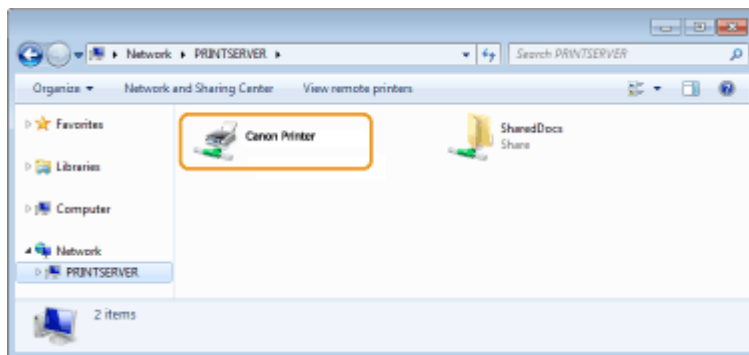

## ■ Displaying the [Software Programs/Manuals Setup] Screen

If your computer does not display the [Software Programs/Manuals Setup] screen after inserting the provided CD-ROM/DVD-ROM, follow the procedure below. The CD-ROM/DVD-ROM drive name is indicated as "D:" in this manual. The CD-ROM/DVD-ROM drive name may differ depending on the computer you are using.

### Windows Vista/7/Server 2008

[Start] ► enter "D:\MInst.exe" in [Search programs and files] or [Start Search] ► press the [ENTER] key.

### Windows 8/Server 2012

Right-click the lower-left corner of the screen ► [Run] ► Enter "D:\MInst.exe" ► click [OK]

### Windows 8.1/Server 2012 R2

Right-click [Start] ► [Run] ► Enter "D:\MInst.exe" ► click [OK]

### Windows 10

Enter "D:\MInst.exe" in the search box ► click [D:\MInst.exe] displayed as the search result.

### Windows Server 2016

Click [ ] ► enter "D:\MInst.exe" ► click [D:\MInst.exe] displayed as the search result.

## ■ Printing a Test Page in Windows

You can check whether the printer driver is operational by printing a test page in Windows.

- 1 Load Letter size paper in the drawer. ▶ Loading Paper in the Drawer(P. 134)**
- 2 Open the printer folder. ▶ Displaying the Printer Folder(P. 556)**
- 3 Right-click the printer driver icon for this machine, and click [Printer properties] or [Properties].**

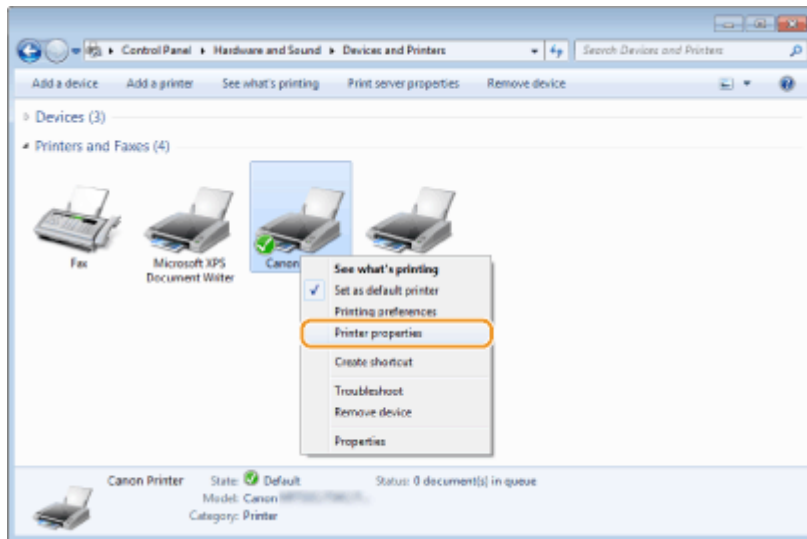

#### 4 Click [Print Test Page] in [General] tab.

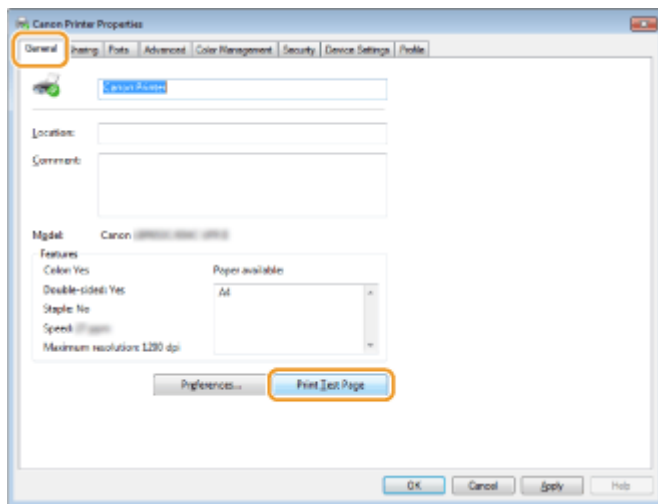

⇒ The test page is printed.

### ■ Checking the Bit Architecture

If you are not sure whether your computer is running 32-bit or 64-bit Windows follow the procedure below.

#### 1 Display [Control Panel].

**Windows Vista/7/Server 2008**  
[Start] ► select [Control Panel].

**Windows 8/Server 2012**  
Right-click the lower-left corner of the screen ► select [Control Panel].

**Windows 8.1/Server 2012 R2**  
Right-click [Start] ► select [Control Panel].

**Windows 10/Server 2016**  
Proceed to step 2.

#### 2 Display [System].

**Windows Vista/7/8/Server 2008 R2/Server 2012**

Click [System and Maintenance] or [System and Security] ► [System].

**Windows 10/Server 2016**

Click [ ] ► [Settings] ► [System] ► select [About].

**Windows Server 2008**

Double-click [System].

**3 Check the bit architecture.****For 32-bit versions**

[32-bit Operating System] is displayed.

**For 64-bit versions**

[64-bit Operating System] is displayed.

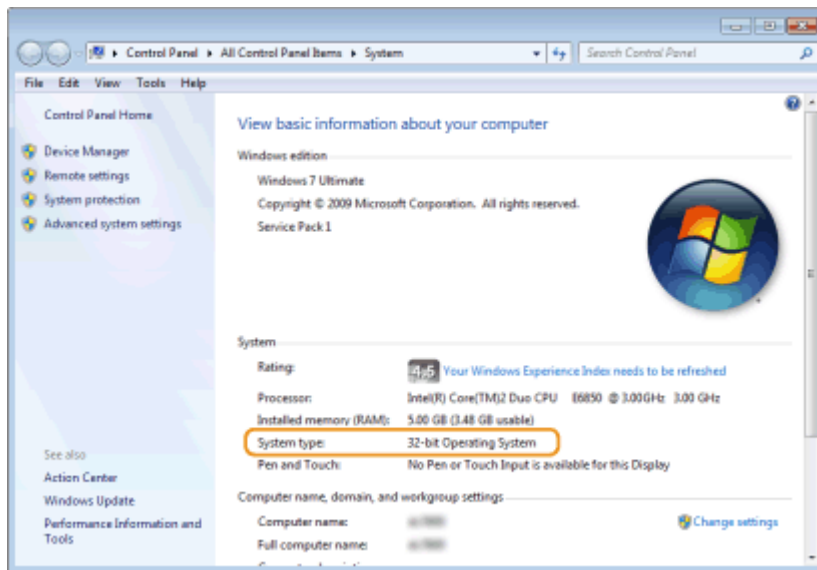
**■ Checking the Computer Name****1 Display [Control Panel].****Windows Vista/7/Server 2008**

[Start] ► select [Control Panel].

**Windows 8/Server 2012**

Right-click the lower-left corner of the screen ► select [Control Panel].

**Windows 8.1/Server 2012 R2**

Right-click [Start] ► select [Control Panel].

**Windows 10**

Click [ ] ► select [Windows System] ► [Control Panel].

**Windows Server 2016**

Right-click [ ] ► select [Control Panel].

**2 Display [System].****Windows Vista/7/8/10/Server 2008 R2/Server 2012/Server 2016**

Click [System and Maintenance] or [System and Security] ► [System].

**Windows Server 2008**  
Double-click [System].

### 3 Check the computer name.

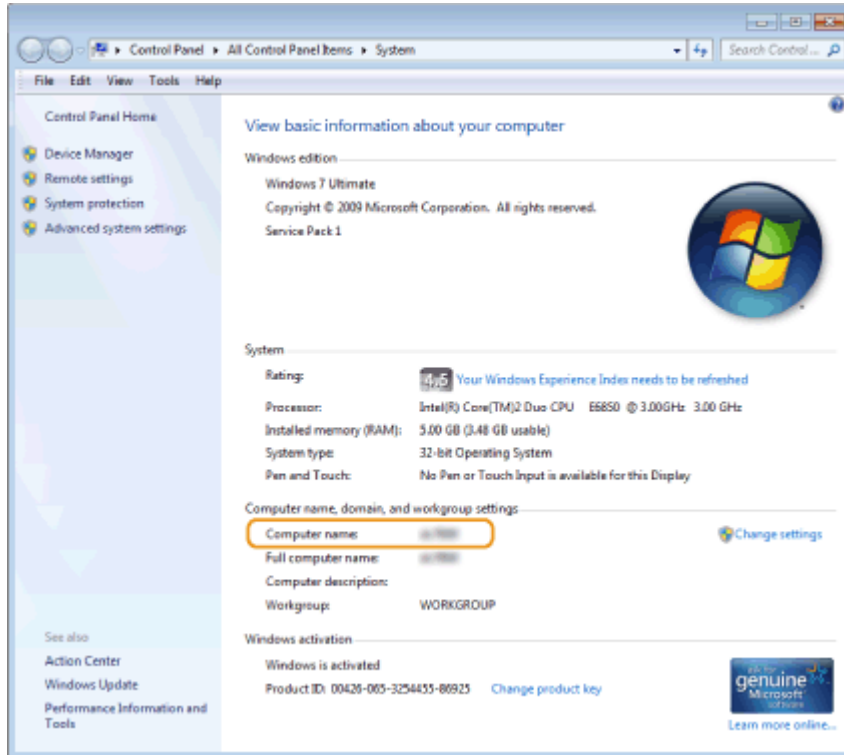

#### ■ Checking the Printer Port

**1** Open the printer folder. ▶ Displaying the Printer Folder(P. 556)

**2** Right-click the printer driver icon for this machine, and click [Printer properties] or [Properties].

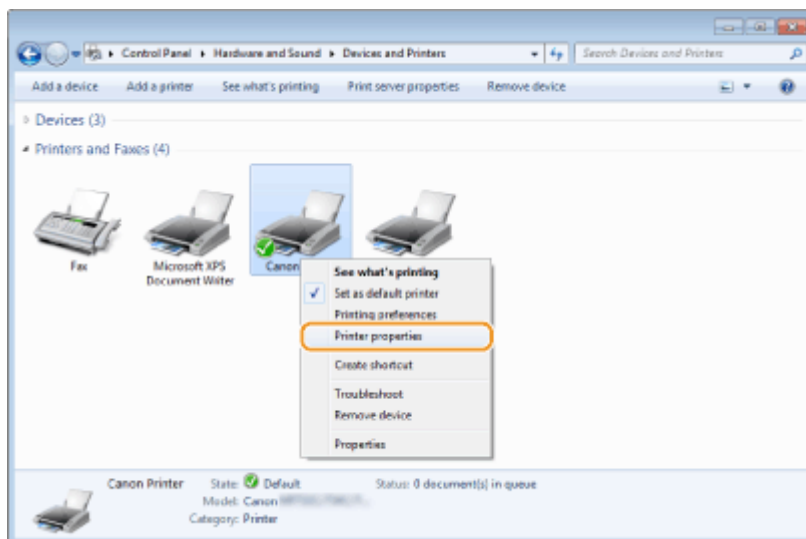



### 3 In the [Ports] tab, check that the port is selected correctly.

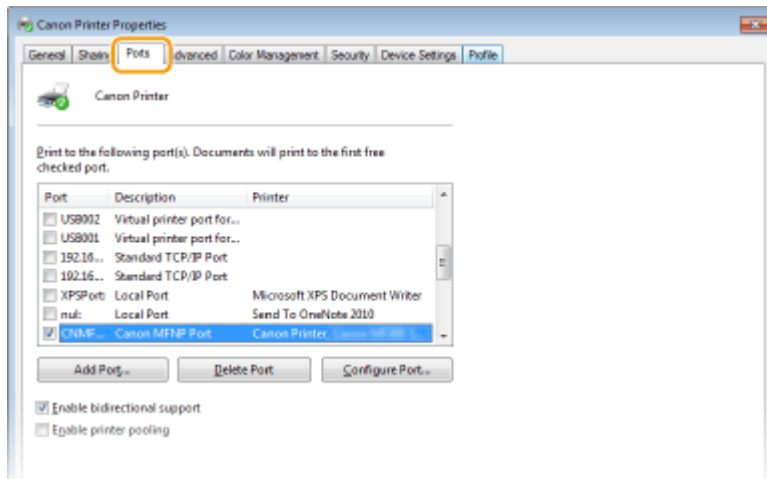

## NOTE

### If you are using a network connection and have changed the machine's IP address

- If [Description] for the selected port is [Canon MFNP Port], and the machine and the computer are on the same subnet, then the connection will be maintained. You do not need to add a new port. If it is [Standard TCP/IP Port], you need to add a new port. ▶ **Configuring Printer Ports(P. 45)**

## ■ Checking Bidirectional Communication

### 1 Open the printer folder. ▶ **Displaying the Printer Folder(P. 556)**

### 2 Right-click the printer driver icon for this machine, and click [Printer properties] or [Properties].

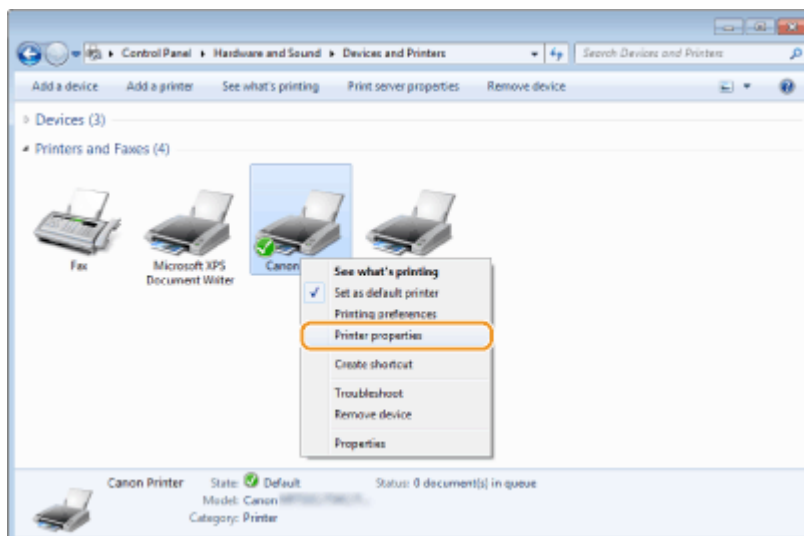

### 3 In the [Ports] tab, make sure that the [Enable bidirectional support] check box is selected.

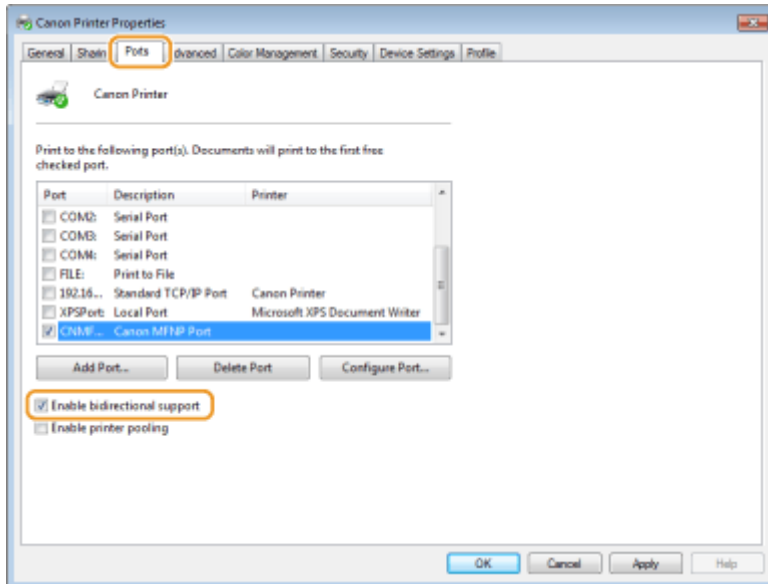

■ **Checking the SSID to Which Your Computer is Connected**

If your computer is connected to a wireless LAN network, click , , or in the system tray to display the SSID of the connected wireless LAN router.

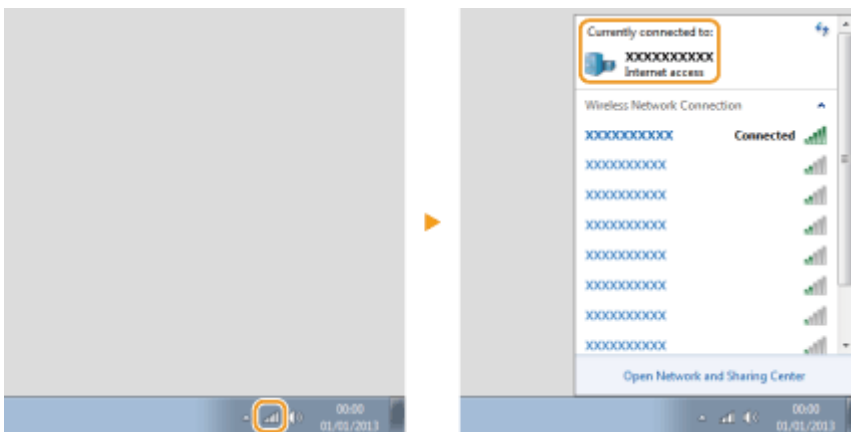

■ **When Printing or Sending from the Windows Store App**

**Windows 8/Windows Server 2012**

Display the charms on the right side of the screen ▶ Tap or click [Devices] ▶ The driver that you use ▶ [Print].

**Windows 8.1/Server 2012 R2**

Display the charms on the right side of the screen ▶ Tap or click [Devices] ▶ [Print] ▶ The driver that you use ▶ [Print].

**Windows 10**

Tap or click [Print] on the application ▶ The driver that you use ▶ [Print].

**NOTE**

- If you print a document or send a fax using this method, only a limited number of functions are available.
- If the message [The printer requires your attention. Go to the desktop to take care of it.] is displayed, go to the desktop and perform the required operations. This message appears when the machine is set to display the user name when printing documents, sending faxes or similar instances.

# Menu Route Map

---

2KUU-0A4

For the settings on the machine's display, see Menu Route Map (PDF manual).

## Touch Panel Model



## 5 Lines LCD Model



## Notice

---

2KUU-0AJ

### ■ International ENERGY STAR Program



As an ENERGY STAR® Partner, Canon has determined that this product meets the ENERGY STAR Program for energy efficiency.

The ENERGY STAR Program is an international program that promotes energy saving through the use of computers and other office equipment.

The program backs the development and dissemination of products with functions that effectively reduce energy consumption. It is an open system in which business proprietors can participate voluntarily.

The targeted products are office equipment, such as computers, displays, printers, facsimiles, and copiers. The standards and logos are uniform among participating nations.

### ■ IPv6 Ready Logo



The protocol stack included in this machine has obtained the IPv6 Ready Logo Phase-1 established by the IPv6 Forum.

### ■ Disclaimers

- The information in this document is subject to change without notice.
- CANON INC. MAKES NO WARRANTY OF ANY KIND WITH REGARD TO THIS MATERIAL, EITHER EXPRESS OR IMPLIED, EXCEPT AS PROVIDED HEREIN, INCLUDING WITHOUT LIMITATION, THEREOF, WARRANTIES AS TO MARKETABILITY, MERCHANTABILITY, FITNESS FOR A PARTICULAR PURPOSE OF USE, OR NON-INFRINGEMENT. CANON INC. SHALL NOT BE LIABLE FOR ANY DIRECT, INCIDENTAL, OR CONSEQUENTIAL DAMAGES OF ANY NATURE, OR LOSSES OR EXPENSES RESULTING FROM THE USE OF THIS MATERIAL.
- If you do not have access to Adobe Reader to view the manuals in PDF format, try other programs such as PDF Preview developed by Vivid Document Imaging Technologies.

### ■ Trademarks

Adobe, Acrobat, and Reader are registered trademarks of Adobe Systems Incorporated in the United States and/or other countries.

Apple, Bonjour, iPad, iPhone, iPod touch, Mac, macOS, OS X and Safari are trademarks of Apple Inc.

Microsoft, Windows, Windows Vista, Windows Server, Internet Explorer, Word and Excel are either registered trademarks or trademarks of Microsoft Corporation in the United States and/or other countries.

iOS is a trademark or registered trademark of Cisco in the U.S. and other countries and is used under license.

Google Cloud Print, Google Chrome and Android are either registered trademarks or trademarks of Google Inc.

Mopria®, the Mopria® Logo and the Mopria® Alliance logo are registered trademarks and service marks of Mopria Alliance, Inc. in the United States and other countries. Unauthorized use is strictly prohibited.

This product contains the Universal Font Scaling Technology or UFST® under license from Monotype Imaging, Inc.

UFST® is a trademark of Monotype Imaging, Inc. registered in the United States Patent and Trademark Office and may be registered in certain jurisdictions.

UFST: Copyright © 1989 - 1996, 1997, 2003, 2004, 2008, all rights reserved, by Monotype Imaging Inc.



The Adobe PDF logo is a trademark or registered trademark of Adobe Systems Incorporated in the United States and other countries.

Copyright © 2008 Adobe Systems Incorporated. All rights reserved.

Protected by U.S. Patents 6,185,684; 6,205,549; 7,213,269; 7,272,628; 7,278,168; Patents pending in the U.S. and other countries.

All instances of the name PostScript in the text are references to the PostScript language as defined by Adobe Systems Incorporated unless otherwise stated. The name PostScript also is used as a product trademark for Adobe Systems' implementation of the PostScript language interpreter.

Except as otherwise stated, any reference to a "PostScript printing device," "PostScript display device," or similar item refers to a printing device, display device or item (respectively) that contains PostScript technology created or licensed by Adobe Systems Incorporated and not to devices or items that purport to be merely compatible with the PostScript language.

Adobe, the Adobe logo, Adobe LiveCycle® Policy Server, InDesign, PostScript, the PostScript Logo, and PostScript 3 are either registered trademarks or trademarks of Adobe Systems Incorporated in the United States and/or other countries.

All other trademarks are the property of their respective owners.

Portions of this software are copyright © 2007 The FreeType Project ([www.freetype.org](http://www.freetype.org)). All rights reserved.

All other product and brand names are registered trademarks, trademarks or service marks of their respective owners.

## ■ Copyright

Reproduction of the contents of this document in whole or in part without prior permission is prohibited.

V\_180118

This Font Software is licensed under the SIL Open Font License, Version 1.1.

This license is copied below, and is also available with a FAQ at: <http://scripts.sil.org/OFL>

-----  
SIL OPEN FONT LICENSE Version 1.1 - 26 February 2007  
-----

#### PREAMBLE

The goals of the Open Font License (OFL) are to stimulate worldwide development of collaborative font projects, to support the font creation efforts of academic and linguistic communities, and to provide a free and open framework in which fonts may be shared and improved in partnership with others.

The OFL allows the licensed fonts to be used, studied, modified and redistributed freely as long as they are not sold by themselves. The fonts, including any derivative works, can be bundled, embedded, redistributed and/or sold with any software provided that any reserved names are not used by derivative works. The fonts and derivatives, however, cannot be released under any other type of license. The requirement for fonts to remain under this license does not apply to any document created using the fonts or their derivatives.

#### DEFINITIONS

"Font Software" refers to the set of files released by the Copyright Holder(s) under this license and clearly marked as such. This may include source files, build scripts and documentation.

"Reserved Font Name" refers to any names specified as such after the copyright statement(s).

"Original Version" refers to the collection of Font Software components as distributed by the Copyright Holder(s).

"Modified Version" refers to any derivative made by adding to, deleting, or substituting -- in part or in whole -- any of the components of the Original Version, by changing formats or by porting the Font Software to a new environment.

"Author" refers to any designer, engineer, programmer, technical writer or other person who contributed to the Font Software.

#### PERMISSION & CONDITIONS

Permission is hereby granted, free of charge, to any person obtaining a copy of the Font Software, to use, study, copy, merge, embed, modify, redistribute, and sell modified and unmodified copies of the Font Software, subject to the following conditions:

- 1) Neither the Font Software nor any of its individual components, in Original or Modified Versions, may be sold by itself.
- 2) Original or Modified Versions of the Font Software may be bundled, redistributed and/or sold with any software, provided that each copy contains the above copyright notice and this license. These can be included either as stand-alone text files, human-readable headers or in the appropriate machine-readable metadata fields within text or binary files as long as those fields can be easily viewed by the user.
- 3) No Modified Version of the Font Software may use the Reserved Font Name(s) unless explicit written permission is granted by the corresponding Copyright Holder. This restriction only applies to the primary font name as presented to the users.
- 4) The name(s) of the Copyright Holder(s) or the Author(s) of the Font Software shall not be used to promote, endorse or advertise any Modified Version, except to acknowledge the contribution(s) of the Copyright Holder(s) and the Author(s) or with their explicit written permission.
- 5) The Font Software, modified or unmodified, in part or in whole, must be distributed entirely under this license, and must not be distributed under any other license. The requirement for fonts to remain under this license does not apply to any document created using the Font Software.

#### TERMINATION

This license becomes null and void if any of the above conditions are not met.

#### DISCLAIMER

THE FONT SOFTWARE IS PROVIDED "AS IS", WITHOUT WARRANTY OF ANY KIND, EXPRESS OR IMPLIED, INCLUDING BUT NOT LIMITED TO ANY WARRANTIES OF MERCHANTABILITY, FITNESS FOR A PARTICULAR PURPOSE AND NONINFRINGEMENT OF COPYRIGHT, PATENT, TRADEMARK, OR OTHER RIGHT. IN NO EVENT SHALL THE COPYRIGHT HOLDER BE LIABLE FOR ANY CLAIM, DAMAGES OR OTHER LIABILITY, INCLUDING ANY GENERAL, SPECIAL, INDIRECT, INCIDENTAL, OR CONSEQUENTIAL DAMAGES, WHETHER IN AN ACTION OF CONTRACT, TORT OR OTHERWISE, ARISING FROM, OUT OF THE USE OR INABILITY TO USE THE FONT SOFTWARE OR FROM OTHER DEALINGS IN THE FONT SOFTWARE.

## The Software Subjected to Other License Conditions

Please refer to Table of Software and respective License terms below, for more detail and corresponding license conditions.

Table of Software

Names of Software	Terms and Conditions of the License: See Page
Adobe PDF Scan Library	2
bldimake	5
carouFredSel	6
FreeType	7
snmp	12
Incl	15
JPEG	16
jQuery	17
jQuery Mobile	18
math	19
mDNSResponder	20
mDNSResponder (part of mDNSShared)	24
OpenSSL	25
xpm	29



Portions use software under the following terms:

---

This product contains either BSAFE and/or TIPEM software by RSA Security Inc.

---

This product includes software developed by the Apache Software Foundation (<http://www.apache.org/>).  
Copyright (c) 1998-2000 The Apache Software Foundation. All rights reserved.

Redistribution and use in source and binary forms, with or without modification, are permitted provided that the following conditions are met:

1. Redistributions of source code must retain the above copyright notice, this list of conditions and the following disclaimer.
2. Redistributions in binary form must reproduce the above copyright notice, this list of conditions and the following disclaimer in the documentation and/or other materials provided with the distribution.
3. The end-user documentation included with the redistribution, if any, must include the following acknowledgment:

"This product includes software developed by the Apache Software Foundation (<http://www.apache.org/>)."

Alternately, this acknowledgment may appear in the software itself, if and wherever such third-party acknowledgments normally appear.

4. The names "Xerces" and "Apache Software Foundation" must not be used to endorse or promote products derived from this software without prior written permission. For written permission, please contact [apache@apache.org](mailto:apache@apache.org).
5. Products derived from this software may not be called "Apache", nor may "Apache" appear in their name, without prior written permission of the Apache Software Foundation.

THIS SOFTWARE IS PROVIDED ``AS IS" AND ANY EXPRESSED OR IMPLIED WARRANTIES, INCLUDING, BUT NOT LIMITED TO, THE IMPLIED WARRANTIES OF MERCHANTABILITY AND FITNESS FOR A PARTICULAR PURPOSE ARE DISCLAIMED. IN NO EVENT SHALL THE APACHE SOFTWARE FOUNDATION OR ITS CONTRIBUTORS BE LIABLE FOR ANY DIRECT, INDIRECT, INCIDENTAL, SPECIAL, EXEMPLARY, OR CONSEQUENTIAL DAMAGES (INCLUDING, BUT NOT LIMITED TO, PROCUREMENT OF SUBSTITUTE GOODS OR SERVICES; LOSS OF USE, DATA, OR PROFITS; OR BUSINESS INTERRUPTION) HOWEVER CAUSED AND ON ANY THEORY OF LIABILITY, WHETHER IN CONTRACT, STRICT LIABILITY, OR TORT (INCLUDING NEGLIGENCE OR OTHERWISE) ARISING IN ANY WAY OUT OF THE USE OF THIS SOFTWARE, EVEN IF ADVISED OF THE POSSIBILITY OF SUCH DAMAGE.

This software consists of voluntary contributions made by many individuals on behalf of the Apache Software Foundation and was originally based on software copyright (c) 1999, International Business Machines, Inc., <http://www.ibm.com>. For more information on the Apache Software Foundation, please see <http://www.apache.org/>.

---

March 27, 2003

Portions of this product are based on Modifications created from the Original Code known as the "Sablotron XSLT Processor". The Sablotron XSLT Processor is subject to the Mozilla Public License Version 1.1 (the "License"). You may obtain a copy of the License at <http://www.mozilla.org/MPL/>

Software distributed under the License is distributed on an "AS IS" basis, WITHOUT WARRANTY OF ANY KIND, either express or implied. See the License for the specific language governing rights and limitations under the License.

The Original Code is the Sablotron XSLT Processor.

The Initial Developer of the Original Code is Ginger Alliance Ltd. Portions created by Ginger Alliance are Copyright (C) 2000 Ginger Alliance Ltd. All Rights Reserved.

Pursuant to sections 3.2 and 3.6 of the License, the Modifications created by Adobe Systems Incorporated are available as Source Code. The Modifications may be downloaded via the Internet from:

<http://partners.adobe.com/asn/tech/xml/sablotron/index.jsp>

The Original Code may be downloaded via the Internet from:

<https://sourceforge.net/projects/sablotron/>

---

Portions Copyright (c) 1997-1999 Silicon Graphics Computer Systems, Inc.

Permission to use, copy, modify, distribute and sell this software and its documentation for any purpose is hereby granted without fee, provided that the above copyright notice appear in all copies and that both that copyright notice and this permission notice appear in supporting documentation. Silicon Graphics makes no representations about the suitability of this software for any purpose. It is provided "as is" without express or implied warranty.

---

The Loki Library

Portions Copyright (c) 2001 by Andrei Alexandrescu . This code accompanies the book: Alexandrescu, Andrei. "Modern C++ Design: Generic Programming and Design Patterns Applied".

Portions Copyright (c) 2001. Addison-Wesley. Permission to use, copy, modify, distribute and sell this software for any purpose is hereby granted without fee, provided that the above copyright notice appear in all copies and that both that copyright notice and this permission notice appear in supporting documentation.

The author or Addison-Wesley Longman make no representations about the suitability of this software for any purpose. It is provided "as is" without express or implied warranty.

---

Updated Information/Additional Third Party Code Information available at  
<http://www.adobe.com/go/thirdparty> .

---

bldimake

Copyright (c) 1985, 1986, 1987, 1988 The Open Group

All right Reserved.

Permission to use, copy, modify, distribute, and sell this software and its documentation for any purpose is hereby granted without fee, provided that the above copyright notice appear in all copies and that both that copyright notice and this permission notice appear in supporting documentation. The above copyright notice and this permission notice shall be included in all copies or substantial portions of the Software.

THE SOFTWARE IS PROVIDED "AS IS", WITHOUT WARRANTY OF ANY KIND, EXPRESS OR IMPLIED, INCLUDING BUT NOT LIMITED TO THE WARRANTIES OF MERCHANTABILITY, FITNESS FOR A PARTICULAR PURPOSE AND NONINFRINGEMENT. IN NO EVENT SHALL THE OPEN GROUP BE LIABLE FOR ANY CLAIM, DAMAGES OR OTHER LIABILITY, WHETHER IN AN ACTION OF CONTRACT, TORT OR OTHERWISE, ARISING FROM, OUT OF OR IN CONNECTION WITH THE SOFTWARE OR THE USE OR OTHER DEALINGS IN THE SOFTWARE.

Except as contained in this notice, the name of The Open Group shall not be used in advertising or otherwise to promote the sale, use or other dealings in this Software without prior written authorization from The Open Group.

carouFredSel

The MIT License (MIT)

Copyright (c) 2012 Fred Heusschen

Permission is hereby granted, free of charge, to any person obtaining a copy of this software and associated documentation files (the "Software"), to deal in the Software without restriction, including without limitation the rights to use, copy, modify, merge, publish, distribute, sublicense, and/or sell copies of the Software, and to permit persons to whom the Software is furnished to do so, subject to the following conditions:

The above copyright notice and this permission notice shall be included in all copies or substantial portions of the Software.

THE SOFTWARE IS PROVIDED "AS IS", WITHOUT WARRANTY OF ANY KIND, EXPRESS OR IMPLIED, INCLUDING BUT NOT LIMITED TO THE WARRANTIES OF MERCHANTABILITY, FITNESS FOR A PARTICULAR PURPOSE AND NONINFRINGEMENT. IN NO EVENT SHALL THE AUTHORS OR COPYRIGHT HOLDERS BE LIABLE FOR ANY CLAIM, DAMAGES OR OTHER LIABILITY, WHETHER IN AN ACTION OF CONTRACT, TORT OR OTHERWISE, ARISING FROM, OUT OF OR IN CONNECTION WITH THE SOFTWARE OR THE USE OR OTHER DEALINGS IN THE SOFTWARE.

## FreeType

### The FreeType Project LICENSE

-----

2006-Jan-27

Copyright 1996-2002, 2006 by  
David Turner, Robert Wilhelm, and Werner Lemberg

### Introduction

=====

The FreeType Project is distributed in several archive packages; some of them may contain, in addition to the FreeType font engine, various tools and contributions which rely on, or relate to, the FreeType Project.

This license applies to all files found in such packages, and which do not fall under their own explicit license. The license affects thus the FreeType font engine, the test programs, documentation and makefiles, at the very least.

This license was inspired by the BSD, Artistic, and IJG (Independent JPEG Group) licenses, which all encourage inclusion and use of free software in commercial and freeware products alike. As a consequence, its main points are that:

- o We don't promise that this software works. However, we will be interested in any kind of bug reports. ('as is' distribution)
- o You can use this software for whatever you want, in parts or full form, without having to pay us. ('royalty-free' usage)
- o You may not pretend that you wrote this software. If you use it, or only parts of it, in a program, you must acknowledge

somewhere in your documentation that you have used the FreeType code. ('credits')

We specifically permit and encourage the inclusion of this software, with or without modifications, in commercial products. We disclaim all warranties covering The FreeType Project and assume no liability related to The FreeType Project.

Finally, many people asked us for a preferred form for a credit/disclaimer to use in compliance with this license. We thus encourage you to use the following text:

\*\*\*\*\*

Portions of this software are copyright © <year> The FreeType Project (www.freetype.org). All rights reserved.

\*\*\*\*\*

Please replace <year> with the value from the FreeType version you actually use.

## Legal Terms

=====

### 0. Definitions

-----

Throughout this license, the terms 'package', 'FreeType Project', and 'FreeType archive' refer to the set of files originally distributed by the authors (David Turner, Robert Wilhelm, and Werner Lemberg) as the 'FreeType Project', be they named as alpha, beta or final release.

'You' refers to the licensee, or person using the project, where 'using' is a generic term including compiling the project's source code as well as linking it to form a 'program' or 'executable'. This program is referred to as 'a program using the FreeType

engine'.

This license applies to all files distributed in the original FreeType Project, including all source code, binaries and documentation, unless otherwise stated in the file in its original, unmodified form as distributed in the original archive.

If you are unsure whether or not a particular file is covered by this license, you must contact us to verify this.

The FreeType Project is copyright (C) 1996-2000 by David Turner, Robert Wilhelm, and Werner Lemberg. All rights reserved except as specified below.

## 1. No Warranty

-----

THE FREETYPE PROJECT IS PROVIDED `AS IS' WITHOUT WARRANTY OF ANY KIND, EITHER EXPRESS OR IMPLIED, INCLUDING, BUT NOT LIMITED TO, WARRANTIES OF MERCHANTABILITY AND FITNESS FOR A PARTICULAR PURPOSE. IN NO EVENT WILL ANY OF THE AUTHORS OR COPYRIGHT HOLDERS BE LIABLE FOR ANY DAMAGES CAUSED BY THE USE OR THE INABILITY TO USE, OF THE FREETYPE PROJECT.

## 2. Redistribution

-----

This license grants a worldwide, royalty-free, perpetual and irrevocable right and license to use, execute, perform, compile, display, copy, create derivative works of, distribute and sublicense the FreeType Project (in both source and object code forms) and derivative works thereof for any purpose; and to authorize others to exercise some or all of the rights granted herein, subject to the following conditions:

- o Redistribution of source code must retain this license file ('FTL.TXT') unaltered; any additions, deletions or changes to the original files must be clearly indicated in accompanying documentation. The copyright notices of the unaltered,



original files must be preserved in all copies of source files.

- o Redistribution in binary form must provide a disclaimer that states that the software is based in part of the work of the FreeType Team, in the distribution documentation. We also encourage you to put an URL to the FreeType web page in your documentation, though this isn't mandatory.

These conditions apply to any software derived from or based on the FreeType Project, not just the unmodified files. If you use our work, you must acknowledge us. However, no fee need be paid to us.

### 3. Advertising

-----

Neither the FreeType authors and contributors nor you shall use the name of the other for commercial, advertising, or promotional purposes without specific prior written permission.

We suggest, but do not require, that you use one or more of the following phrases to refer to this software in your documentation or advertising materials: 'FreeType Project', 'FreeType Engine', 'FreeType library', or 'FreeType Distribution'.

As you have not signed this license, you are not required to accept it. However, as the FreeType Project is copyrighted material, only this license, or another one contracted with the authors, grants you the right to use, distribute, and modify it. Therefore, by using, distributing, or modifying the FreeType Project, you indicate that you understand and accept all the terms of this license.

### 4. Contacts

-----

There are two mailing lists related to FreeType:

o [freetype@nongnu.org](mailto:freetype@nongnu.org)

Discusses general use and applications of FreeType, as well as future and wanted additions to the library and distribution.

If you are looking for support, start in this list if you haven't found anything to help you in the documentation.

o [freetype-devel@nongnu.org](mailto:freetype-devel@nongnu.org)

Discusses bugs, as well as engine internals, design issues, specific licenses, porting, etc.

Our home page can be found at

<http://www.freetype.org>

--- end of FTL.TXT ---

snmp

Copyright 1988, 1989 by Carnegie Mellon University

All Rights Reserved

Permission to use, copy, modify, and distribute this software and its documentation for any purpose and without fee is hereby granted, provided that the above copyright notice appear in all copies and that both that copyright notice and this permission notice appear in supporting documentation, and that the name of CMU not be used in advertising or publicity pertaining to distribution of the software without specific, written prior permission.

CMU DISCLAIMS ALL WARRANTIES WITH REGARD TO THIS SOFTWARE, INCLUDING ALL IMPLIED WARRANTIES OF MERCHANTABILITY AND FITNESS, IN NO EVENT SHALL CMU BE LIABLE FOR ANY SPECIAL, INDIRECT OR CONSEQUENTIAL DAMAGES OR ANY DAMAGES WHATSOEVER RESULTING FROM LOSS OF USE, DATA OR PROFITS, WHETHER IN AN ACTION OF CONTRACT, NEGLIGENCE OR OTHER TORTIOUS ACTION, ARISING OUT OF OR IN CONNECTION WITH THE USE OR PERFORMANCE OF THIS SOFTWARE.

/\* Copyright (C) 1995-1998 Eric Young (eay@cryptsoft.com)

\* All rights reserved.

\*

\* This package is an SSL implementation written

\* by Eric Young (eay@cryptsoft.com).

\* The implementation was written so as to conform with Netscapes SSL.

\*

\* This library is free for commercial and non-commercial use as long as

\* the following conditions are adhered to. The following conditions

\* apply to all code found in this distribution, be it the RC4, RSA,

\* lhash, DES, etc., code; not just the SSL code. The SSL documentation

\* included with this distribution is covered by the same copyright terms

\* except that the holder is Tim Hudson (tjh@cryptsoft.com).

\*

\* Copyright remains Eric Young's, and as such any Copyright notices in

- \* the code are not to be removed.
- \* If this package is used in a product, Eric Young should be given attribution
- \* as the author of the parts of the library used.
- \* This can be in the form of a textual message at program startup or
- \* in documentation (online or textual) provided with the package.
- \*
- \* Redistribution and use in source and binary forms, with or without
- \* modification, are permitted provided that the following conditions
- \* are met:
- \* 1. Redistributions of source code must retain the copyright
- \* notice, this list of conditions and the following disclaimer.
- \* 2. Redistributions in binary form must reproduce the above copyright
- \* notice, this list of conditions and the following disclaimer in the
- \* documentation and/or other materials provided with the distribution.
- \* 3. All advertising materials mentioning features or use of this software
- \* must display the following acknowledgement:
- \* "This product includes cryptographic software written by
- \* Eric Young (eay@cryptsoft.com)"
- \* The word 'cryptographic' can be left out if the routines from the library
- \* being used are not cryptographic related :-).
- \* 4. If you include any Windows specific code (or a derivative thereof) from
- \* the apps directory (application code) you must include an acknowledgement:
- \* "This product includes software written by Tim Hudson (tjh@cryptsoft.com)"
- \*
- \* THIS SOFTWARE IS PROVIDED BY ERIC YOUNG ``AS IS" AND
- \* ANY EXPRESS OR IMPLIED WARRANTIES, INCLUDING, BUT NOT LIMITED TO, THE
- \* IMPLIED WARRANTIES OF MERCHANTABILITY AND FITNESS FOR A PARTICULAR PURPOSE
- \* ARE DISCLAIMED. IN NO EVENT SHALL THE AUTHOR OR CONTRIBUTORS BE LIABLE
- \* FOR ANY DIRECT, INDIRECT, INCIDENTAL, SPECIAL, EXEMPLARY, OR CONSEQUENTIAL
- \* DAMAGES (INCLUDING, BUT NOT LIMITED TO, PROCUREMENT OF SUBSTITUTE GOODS
- \* OR SERVICES; LOSS OF USE, DATA, OR PROFITS; OR BUSINESS INTERRUPTION)
- \* HOWEVER CAUSED AND ON ANY THEORY OF LIABILITY, WHETHER IN CONTRACT, STRICT
- \* LIABILITY, OR TORT (INCLUDING NEGLIGENCE OR OTHERWISE) ARISING IN ANY WAY
- \* OUT OF THE USE OF THIS SOFTWARE, EVEN IF ADVISED OF THE POSSIBILITY OF
- \* SUCH DAMAGE.
- \*
- \* The licence and distribution terms for any publically available version or
- \* derivative of this code cannot be changed. i.e. this code cannot simply be

\* copied and put under another distribution licence

\* [including the GNU Public Licence.]

\*/

Copyright 1988, 1989 by Carnegie Mellon University

Copyright 1989 TGV, Incorporated

All Rights Reserved

Permission to use, copy, modify, and distribute this software and its documentation for any purpose and without fee is hereby granted, provided that the above copyright notice appear in all copies and that both that copyright notice and this permission notice appear in supporting documentation, and that the name of CMU and TGV not be used in advertising or publicity pertaining to distribution of the software without specific, written prior permission.

CMU AND TGV DISCLAIMS ALL WARRANTIES WITH REGARD TO THIS SOFTWARE, INCLUDING ALL IMPLIED WARRANTIES OF MERCHANTABILITY AND FITNESS, IN NO EVENT SHALL CMU OR TGV BE LIABLE FOR ANY SPECIAL, INDIRECT OR CONSEQUENTIAL DAMAGES OR ANY DAMAGES WHATSOEVER RESULTING FROM LOSS OF USE, DATA OR PROFITS, WHETHER IN AN ACTION OF CONTRACT, NEGLIGENCE OR OTHER TORTIOUS ACTION, ARISING OUT OF OR IN CONNECTION WITH THE USE OR PERFORMANCE OF THIS SOFTWARE.

Incl

Copyright (c) 1994-96 SunSoft, Inc.

Permission is hereby granted, free of charge, to any person obtaining a copy of this software and associated documentation files (the "Software"), to deal in the Software without restriction, including without limitation the rights to use, copy, modify, merge, publish, distribute, sublicense, and/or sell copies of the Software, and to permit persons to whom the Software is furnished to do so, subject to the following conditions:

The above copyright notice and this permission notice shall be included in all copies or substantial portions of the Software.

THE SOFTWARE IS PROVIDED "AS IS", WITHOUT WARRANTY OF ANY KIND, EXPRESS OR IMPLIED, INCLUDING BUT NOT LIMITED TO THE WARRANTIES OF MERCHANTABILITY, FITNESS FOR A PARTICULAR PURPOSE AND NONINFRINGEMENT. IN NO EVENT SHALL SUNSOFT INC. OR ITS PARENT COMPANY BE LIABLE FOR ANY CLAIM, DAMAGES OR OTHER LIABILITY, WHETHER IN AN ACTION OF CONTRACT, TORT OR OTHERWISE, ARISING FROM, OUT OF OR IN CONNECTION WITH THE SOFTWARE OR THE USE OR OTHER DEALINGS IN THE SOFTWARE.

Except as contained in this notice, the name of SunSoft, Inc. shall not be used in advertising or otherwise to promote the sale, use or other dealings in this Software without prior written authorization from SunSoft, Inc.

## JPEG

"this software is based in part on the work of the Independent JPEG Group."

## jQuery

Copyright 2012 jQuery Foundation and other contributors

<http://jquery.com/>

Permission is hereby granted, free of charge, to any person obtaining a copy of this software and associated documentation files (the "Software"), to deal in the Software without restriction, including without limitation the rights to use, copy, modify, merge, publish, distribute, sublicense, and/or sell copies of the Software, and to permit persons to whom the Software is furnished to do so, subject to the following conditions:

The above copyright notice and this permission notice shall be included in all copies or substantial portions of the Software.

THE SOFTWARE IS PROVIDED "AS IS", WITHOUT WARRANTY OF ANY KIND, EXPRESS OR IMPLIED, INCLUDING BUT NOT LIMITED TO THE WARRANTIES OF MERCHANTABILITY, FITNESS FOR A PARTICULAR PURPOSE AND NONINFRINGEMENT. IN NO EVENT SHALL THE AUTHORS OR COPYRIGHT HOLDERS BE LIABLE FOR ANY CLAIM, DAMAGES OR OTHER LIABILITY, WHETHER IN AN ACTION OF CONTRACT, TORT OR OTHERWISE, ARISING FROM, OUT OF OR IN CONNECTION WITH THE SOFTWARE OR THE USE OR OTHER DEALINGS IN THE SOFTWARE.



jQuery Mobile

Copyright (C) 2010, 2014 jQuery Foundation, Inc. and other contributors

<http://jquery.org/license>

Permission is hereby granted, free of charge, to any person obtaining a copy of this software and associated documentation files (the "Software"), to deal in the Software without restriction, including without limitation the rights to use, copy, modify, merge, publish, distribute, sublicense, and/or sell copies of the Software, and to permit persons to whom the Software is furnished to do so, subject to the following conditions:

The above copyright notice and this permission notice shall be included in all copies or substantial portions of the Software.

THE SOFTWARE IS PROVIDED "AS IS", WITHOUT WARRANTY OF ANY KIND, EXPRESS OR IMPLIED, INCLUDING BUT NOT LIMITED TO THE WARRANTIES OF MERCHANTABILITY, FITNESS FOR A PARTICULAR PURPOSE AND NONINFRINGEMENT. IN NO EVENT SHALL THE AUTHORS OR COPYRIGHT HOLDERS BE LIABLE FOR ANY CLAIM, DAMAGES OR OTHER LIABILITY, WHETHER IN AN ACTION OF CONTRACT, TORT OR OTHERWISE, ARISING FROM, OUT OF OR IN CONNECTION WITH THE SOFTWARE OR THE USE OR OTHER DEALINGS IN THE SOFTWARE.

math

Copyright (c) 1993 by Sun Microsystems, Inc. All rights reserved.

Developed at SunPro, a Sun Microsystems, Inc. business.

Permission to use, copy, modify, and distribute this software is freely granted, provided that this notice is preserved.

---

copysignf.c:\*      Copyright (c) 1993 by Sun Microsystems, Inc. All rights reserved.

math\_private.h:\*      Copyright (c) 1993 by Sun Microsystems, Inc. All rights reserved.

powf.c:\*      Copyright (c) 1993 by Sun Microsystems, Inc. All rights reserved.

scalbnf.c:\*      Copyright (c) 1993 by Sun Microsystems, Inc. All rights reserved.

Apache License

Version 2.0, January 2004

<http://www.apache.org/licenses/>

TERMS AND CONDITIONS FOR USE, REPRODUCTION, AND DISTRIBUTION

**1. Definitions.**

"License" shall mean the terms and conditions for use, reproduction, and distribution as defined by Sections 1 through 9 of this document.

"Licensor" shall mean the copyright owner or entity authorized by the copyright owner that is granting the License.

"Legal Entity" shall mean the union of the acting entity and all other entities that control, are controlled by, or are under common control with that entity. For the purposes of this definition, "control" means (i) the power, direct or indirect, to cause the direction or management of such entity, whether by contract or otherwise, or (ii) ownership of fifty percent (50%) or more of the outstanding shares, or (iii) beneficial ownership of such entity.

"You" (or "Your") shall mean an individual or Legal Entity exercising permissions granted by this License.

"Source" form shall mean the preferred form for making modifications, including but not limited to software source code, documentation source, and configuration files.

"Object" form shall mean any form resulting from mechanical transformation or translation of a Source form, including but not limited to compiled object code, generated documentation, and conversions to other media types.

"Work" shall mean the work of authorship, whether in Source or Object form, made available under the License, as indicated by a copyright notice that is included in or attached to the work (an example is provided in the Appendix below).

"Derivative Works" shall mean any work, whether in Source or Object form, that is based on (or derived from) the Work and for which the editorial revisions, annotations, elaborations, or other modifications represent, as a whole, an original work of authorship. For the purposes of this License, Derivative Works shall not include works that remain separable from, or merely link (or bind by name) to the interfaces of, the Work and Derivative Works thereof.

"Contribution" shall mean any work of authorship, including the original version of the Work and any modifications or additions to that Work or Derivative Works thereof, that is intentionally submitted to Licensor for inclusion in the Work by the copyright owner or by an individual or Legal Entity authorized to submit on behalf of the copyright owner. For the purposes of this definition, "submitted" means any form of electronic, verbal, or written communication sent to the Licensor or its representatives, including but not limited to communication on electronic mailing lists, source code control systems, and issue tracking systems that are managed by, or on behalf of, the Licensor for the purpose of discussing and improving the Work, but excluding communication that is conspicuously marked or otherwise designated in writing by the copyright owner as "Not a Contribution."

"Contributor" shall mean Licensor and any individual or Legal Entity on behalf of whom a Contribution has been received by Licensor and subsequently incorporated within the Work.

**2. Grant of Copyright License.** Subject to the terms and conditions of this License, each Contributor hereby grants to You a perpetual, worldwide, non-exclusive, no-charge, royalty-free, irrevocable copyright license to reproduce, prepare Derivative Works of, publicly display, publicly perform, sublicense, and distribute the Work and such Derivative Works in Source or Object form.

**3. Grant of Patent License.** Subject to the terms and conditions of this License, each Contributor hereby grants to You a perpetual, worldwide, non-exclusive, no-charge, royalty-free, irrevocable (except as stated in this section) patent license to make, have made, use, offer to sell, sell, import, and otherwise transfer the Work, where such license applies only to those patent claims licensable by such Contributor that are necessarily infringed by their Contribution(s) alone or by combination of their Contribution(s) with the Work to which such Contribution(s) was submitted. If You institute patent litigation against any entity (including a cross-claim or counterclaim in a lawsuit) alleging that the Work or a Contribution incorporated within the Work constitutes direct or contributory patent infringement, then any patent licenses granted to You under this License for that Work shall terminate as of the date such litigation is filed.

**4. Redistribution.** You may reproduce and distribute copies of the Work or Derivative Works thereof in any medium, with or without modifications, and in Source or Object form, provided that You meet the following conditions:

- a. You must give any other recipients of the Work or Derivative Works a copy of this License; and
- b. You must cause any modified files to carry prominent notices stating that You changed the files; and
- c. You must retain, in the Source form of any Derivative Works that You distribute, all copyright, patent, trademark, and attribution notices from the Source form of the Work, excluding those notices that do not pertain to any part of the Derivative Works; and

- d. If the Work includes a "NOTICE" text file as part of its distribution, then any Derivative Works that You distribute must include a readable copy of the attribution notices contained within such NOTICE file, excluding those notices that do not pertain to any part of the Derivative Works, in at least one of the following places: within a NOTICE text file distributed as part of the Derivative Works; within the Source form or documentation, if provided along with the Derivative Works; or, within a display generated by the Derivative Works, if and wherever such third-party notices normally appear. The contents of the NOTICE file are for informational purposes only and do not modify the License. You may add Your own attribution notices within Derivative Works that You distribute, alongside or as an addendum to the NOTICE text from the Work, provided that such additional attribution notices cannot be construed as modifying the License.

You may add Your own copyright statement to Your modifications and may provide additional or different license terms and conditions for use, reproduction, or distribution of Your modifications, or for any such Derivative Works as a whole, provided Your use, reproduction, and distribution of the Work otherwise complies with the conditions stated in this License.

**5. Submission of Contributions.** Unless You explicitly state otherwise, any Contribution intentionally submitted for inclusion in the Work by You to the Licensor shall be under the terms and conditions of this License, without any additional terms or conditions. Notwithstanding the above, nothing herein shall supersede or modify the terms of any separate license agreement you may have executed with Licensor regarding such Contributions.

**6. Trademarks.** This License does not grant permission to use the trade names, trademarks, service marks, or product names of the Licensor, except as required for reasonable and customary use in describing the origin of the Work and reproducing the content of the NOTICE file.

**7. Disclaimer of Warranty.** Unless required by applicable law or agreed to in writing, Licensor provides the Work (and each Contributor provides its Contributions) on an "AS IS" BASIS, WITHOUT WARRANTIES OR CONDITIONS OF ANY KIND, either express or implied, including, without limitation, any warranties or conditions of TITLE, NON-INFRINGEMENT, MERCHANTABILITY, or FITNESS FOR A PARTICULAR PURPOSE. You are solely responsible for determining the appropriateness of using or redistributing the Work and assume any risks associated with Your exercise of permissions under this License.

**8. Limitation of Liability.** In no event and under no legal theory, whether in tort (including negligence), contract, or otherwise, unless required by applicable law (such as deliberate and grossly negligent acts) or agreed to in writing, shall any Contributor be liable to You for damages, including any direct, indirect, special, incidental, or consequential damages of any character arising as a result of this License or out of the use or inability to use the Work (including but not limited to damages for loss of goodwill, work stoppage, computer failure or

malfunction, or any and all other commercial damages or losses), even if such Contributor has been advised of the possibility of such damages.

**9. Accepting Warranty or Additional Liability.** While redistributing the Work or Derivative Works thereof, You may choose to offer, and charge a fee for, acceptance of support, warranty, indemnity, or other liability obligations and/or rights consistent with this License. However, in accepting such obligations, You may act only on Your own behalf and on Your sole responsibility, not on behalf of any other Contributor, and only if You agree to indemnify, defend, and hold each Contributor harmless for any liability incurred by, or claims asserted against, such Contributor by reason of your accepting any such warranty or additional liability.

END OF TERMS AND CONDITIONS

#### **APPENDIX: How to apply the Apache License to your work**

To apply the Apache License to your work, attach the following boilerplate notice, with the fields enclosed by brackets "[ ]" replaced with your own identifying information. (Don't include the brackets!) The text should be enclosed in the appropriate comment syntax for the file format. We also recommend that a file or class name and description of purpose be included on the same "printed page" as the copyright notice for easier identification within third-party archives.

Copyright [yyyy] [name of copyright owner] Licensed under the Apache License, Version 2.0 (the "License"); you may not use this file except in compliance with the License. You may obtain a copy of the License at <http://www.apache.org/licenses/LICENSE-2.0> Unless required by applicable law or agreed to in writing, software distributed under the License is distributed on an "AS IS" BASIS, WITHOUT WARRANTIES OR CONDITIONS OF ANY KIND, either express or implied. See the License for the specific language governing permissions and limitations under the License.

mDNSResponder (part of mDNSShared)

\* Copyright (c) 2003-2004, Apple Computer, Inc. All rights reserved.

\*

\* Redistribution and use in source and binary forms, with or without  
\* modification, are permitted provided that the following conditions are met:

\*

- \* 1. Redistributions of source code must retain the above copyright notice,  
\* this list of conditions and the following disclaimer.
- \* 2. Redistributions in binary form must reproduce the above copyright notice,  
\* this list of conditions and the following disclaimer in the documentation  
\* and/or other materials provided with the distribution.
- \* 3. Neither the name of Apple Computer, Inc. ("Apple") nor the names of its  
\* contributors may be used to endorse or promote products derived from this  
\* software without specific prior written permission.

\*

\* THIS SOFTWARE IS PROVIDED BY APPLE AND ITS CONTRIBUTORS "AS IS" AND ANY  
\* EXPRESS OR IMPLIED WARRANTIES, INCLUDING, BUT NOT LIMITED TO, THE IMPLIED  
\* WARRANTIES OF MERCHANTABILITY AND FITNESS FOR A PARTICULAR PURPOSE ARE  
\* DISCLAIMED. IN NO EVENT SHALL APPLE OR ITS CONTRIBUTORS BE LIABLE FOR ANY  
\* DIRECT, INDIRECT, INCIDENTAL, SPECIAL, EXEMPLARY, OR CONSEQUENTIAL DAMAGES  
\* (INCLUDING, BUT NOT LIMITED TO, PROCUREMENT OF SUBSTITUTE GOODS OR SERVICES;  
\* LOSS OF USE, DATA, OR PROFITS; OR BUSINESS INTERRUPTION) HOWEVER CAUSED AND  
\* ON ANY THEORY OF LIABILITY, WHETHER IN CONTRACT, STRICT LIABILITY, OR TORT  
\* (INCLUDING NEGLIGENCE OR OTHERWISE) ARISING IN ANY WAY OUT OF THE USE OF THIS  
\* SOFTWARE, EVEN IF ADVISED OF THE POSSIBILITY OF SUCH DAMAGE.

\*/

## OpenSSL

### OpenSSL License

-----

/\* =====

\* Copyright (c) 1998-2011 The OpenSSL Project. All rights reserved.

\*

\* Redistribution and use in source and binary forms, with or without

\* modification, are permitted provided that the following conditions

\* are met:

\*

\* 1. Redistributions of source code must retain the above copyright

\* notice, this list of conditions and the following disclaimer.

\*

\* 2. Redistributions in binary form must reproduce the above copyright

\* notice, this list of conditions and the following disclaimer in

\* the documentation and/or other materials provided with the

\* distribution.

\*

\* 3. All advertising materials mentioning features or use of this

\* software must display the following acknowledgment:

\* "This product includes software developed by the OpenSSL Project

\* for use in the OpenSSL Toolkit. (<http://www.openssl.org/>)"

\*

\* 4. The names "OpenSSL Toolkit" and "OpenSSL Project" must not be used to

\* endorse or promote products derived from this software without

\* prior written permission. For written permission, please contact

\* [openssl-core@openssl.org](mailto:openssl-core@openssl.org).

\*

\* 5. Products derived from this software may not be called "OpenSSL"

\* nor may "OpenSSL" appear in their names without prior written

\* permission of the OpenSSL Project.

\*

\* 6. Redistributions of any form whatsoever must retain the following

\* acknowledgment:

\* "This product includes software developed by the OpenSSL Project

\* for use in the OpenSSL Toolkit (<http://www.openssl.org/>)"



\*  
\* THIS SOFTWARE IS PROVIDED BY THE OpenSSL PROJECT ``AS IS" AND ANY  
\* EXPRESSED OR IMPLIED WARRANTIES, INCLUDING, BUT NOT LIMITED TO, THE  
\* IMPLIED WARRANTIES OF MERCHANTABILITY AND FITNESS FOR A PARTICULAR  
\* PURPOSE ARE DISCLAIMED. IN NO EVENT SHALL THE OpenSSL PROJECT OR  
\* ITS CONTRIBUTORS BE LIABLE FOR ANY DIRECT, INDIRECT, INCIDENTAL,  
\* SPECIAL, EXEMPLARY, OR CONSEQUENTIAL DAMAGES (INCLUDING, BUT  
\* NOT LIMITED TO, PROCUREMENT OF SUBSTITUTE GOODS OR SERVICES;  
\* LOSS OF USE, DATA, OR PROFITS; OR BUSINESS INTERRUPTION)  
\* HOWEVER CAUSED AND ON ANY THEORY OF LIABILITY, WHETHER IN CONTRACT,  
\* STRICT LIABILITY, OR TORT (INCLUDING NEGLIGENCE OR OTHERWISE)  
\* ARISING IN ANY WAY OUT OF THE USE OF THIS SOFTWARE, EVEN IF ADVISED  
\* OF THE POSSIBILITY OF SUCH DAMAGE.

\* =====

\*  
\* This product includes cryptographic software written by Eric Young  
\* (eay@cryptsoft.com). This product includes software written by Tim  
\* Hudson (tjh@cryptsoft.com).

\*  
\*/

Original SSLeay License

-----

/\* Copyright (C) 1995-1998 Eric Young (eay@cryptsoft.com)

\* All rights reserved.

\*

\* This package is an SSL implementation written

\* by Eric Young (eay@cryptsoft.com).

\* The implementation was written so as to conform with Netscapes SSL.

\*

\* This library is free for commercial and non-commercial use as long as

\* the following conditions are adhered to. The following conditions

\* apply to all code found in this distribution, be it the RC4, RSA,

\* lhash, DES, etc., code; not just the SSL code. The SSL documentation

\* included with this distribution is covered by the same copyright terms

\* except that the holder is Tim Hudson (tjh@cryptsoft.com).

\*

\* Copyright remains Eric Young's, and as such any Copyright notices in  
\* the code are not to be removed.

\* If this package is used in a product, Eric Young should be given attribution  
\* as the author of the parts of the library used.

\* This can be in the form of a textual message at program startup or  
\* in documentation (online or textual) provided with the package.

\*

\* Redistribution and use in source and binary forms, with or without  
\* modification, are permitted provided that the following conditions  
\* are met:

\* 1. Redistributions of source code must retain the copyright  
\* notice, this list of conditions and the following disclaimer.

\* 2. Redistributions in binary form must reproduce the above copyright  
\* notice, this list of conditions and the following disclaimer in the  
\* documentation and/or other materials provided with the distribution.

\* 3. All advertising materials mentioning features or use of this software  
\* must display the following acknowledgement:  
\* "This product includes cryptographic software written by  
\* Eric Young (eay@cryptsoft.com)"  
\* The word 'cryptographic' can be left out if the routines from the library  
\* being used are not cryptographic related :-).

\* 4. If you include any Windows specific code (or a derivative thereof) from  
\* the apps directory (application code) you must include an acknowledgement:  
\* "This product includes software written by Tim Hudson (tjh@cryptsoft.com)"

\*

\* THIS SOFTWARE IS PROVIDED BY ERIC YOUNG ``AS IS" AND  
\* ANY EXPRESS OR IMPLIED WARRANTIES, INCLUDING, BUT NOT LIMITED TO, THE  
\* IMPLIED WARRANTIES OF MERCHANTABILITY AND FITNESS FOR A PARTICULAR PURPOSE  
\* ARE DISCLAIMED. IN NO EVENT SHALL THE AUTHOR OR CONTRIBUTORS BE LIABLE  
\* FOR ANY DIRECT, INDIRECT, INCIDENTAL, SPECIAL, EXEMPLARY, OR CONSEQUENTIAL  
\* DAMAGES (INCLUDING, BUT NOT LIMITED TO, PROCUREMENT OF SUBSTITUTE GOODS  
\* OR SERVICES; LOSS OF USE, DATA, OR PROFITS; OR BUSINESS INTERRUPTION)  
\* HOWEVER CAUSED AND ON ANY THEORY OF LIABILITY, WHETHER IN CONTRACT, STRICT  
\* LIABILITY, OR TORT (INCLUDING NEGLIGENCE OR OTHERWISE) ARISING IN ANY WAY  
\* OUT OF THE USE OF THIS SOFTWARE, EVEN IF ADVISED OF THE POSSIBILITY OF  
\* SUCH DAMAGE.

\*

\* The licence and distribution terms for any publically available version or

\* derivative of this code cannot be changed. i.e. this code cannot simply be

\* copied and put under another distribution licence

\* [including the GNU Public Licence.]

\*/

xpm

Copyright (c) 1989-95 GROUPE BULL

Permission is hereby granted, free of charge, to any person obtaining a copy of this software and associated documentation files (the "Software"), to deal in the Software without restriction, including without limitation the rights to use, copy, modify, merge, publish, distribute, sublicense, and/or sell copies of the Software, and to permit persons to whom the Software is furnished to do so, subject to the following conditions:

The above copyright notice and this permission notice shall be included in all copies or substantial portions of the Software.

THE SOFTWARE IS PROVIDED "AS IS", WITHOUT WARRANTY OF ANY KIND, EXPRESS OR IMPLIED, INCLUDING BUT NOT LIMITED TO THE WARRANTIES OF MERCHANTABILITY, FITNESS FOR A PARTICULAR PURPOSE AND NONINFRINGEMENT. IN NO EVENT SHALL GROUPE BULL BE LIABLE FOR ANY CLAIM, DAMAGES OR OTHER LIABILITY, WHETHER IN AN ACTION OF CONTRACT, TORT OR OTHERWISE, ARISING FROM, OUT OF OR IN CONNECTION WITH THE SOFTWARE OR THE USE OR OTHER DEALINGS IN THE SOFTWARE.

Except as contained in this notice, the name of GROUPE BULL shall not be used in advertising or otherwise to promote the sale, use or other dealings in this Software without prior written authorization from GROUPE BULL.