

Canon

PIXMA G2110 series

PIXMA G2610 series

Getting Started

Guía de inicio

Para Começar

Read **Safety and Important Information** (addendum) first.

Lea primero **Información de seguridad e información importante** (apéndice).

Leia **Informações Importantes e Sobre Segurança** (adendo) primeiro.



QT62212V01

1



Installing the Printer.....page 1

Instalación de la impresora.....página 1

Instalando a impressorapágina 1

2



Connecting with Computerpage 4

Conexión con el ordenadorpágina 4

Conectando a um computadorpágina 4

How to Hold Printer

Cómo sujetar la impresora

Como segurar a impressora

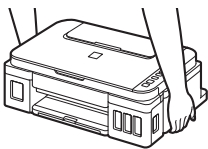

Explanatory Movies

Películas explicativas

Filmes explicativos



<http://ij.start.canon>



3.XXXXXXXXXXXXXXX

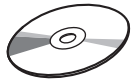
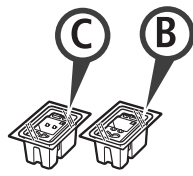
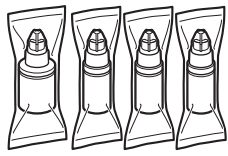

1. Checking Included Items

-  □ Power cord
-  □ Setup CD-ROM for Windows PC
-  □ Cartridge
-  □ Ink bottle
- Safety and Important Information
- Getting Started (this manual)

2. Removing Packing Materials



- 1 Remove the packing materials (such as orange tape) from outside the printer.
- 2 **1** Open the scanning unit / cover.
2 Remove the orange tape and the protective material and discard them.

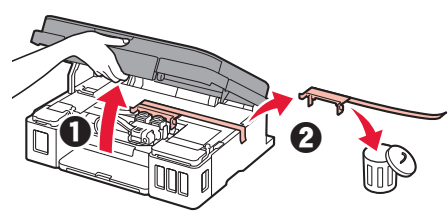

3. Installing the Cartridge



- 1 Open the cartridge locking cover.

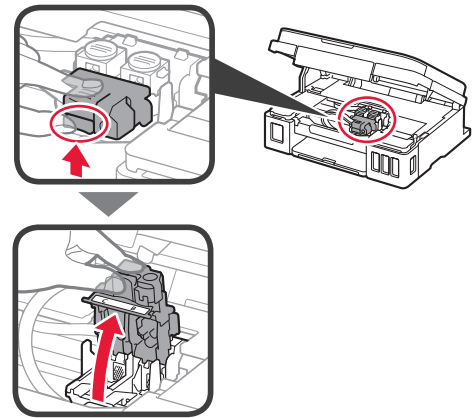

- 2 Take out the C (color) cartridge from the package and remove the label.

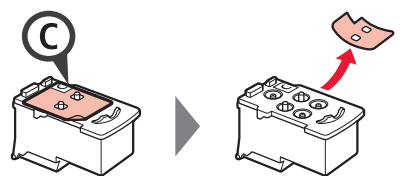

- 3 Remove the protective tape.

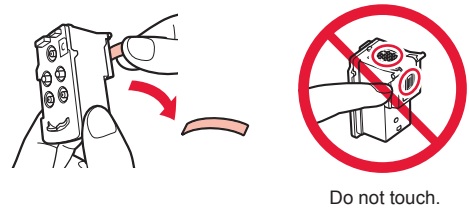

- 4 Insert the C (color) cartridge on the left.

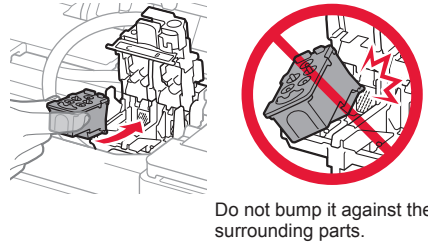

- 5 Repeat steps 2 to 4 to insert the B (black) cartridge on the right.

- 6 Close the cartridge locking cover and push it down.

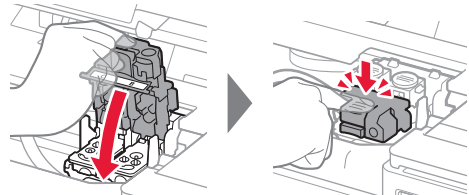

- 7 Press down both joint buttons.

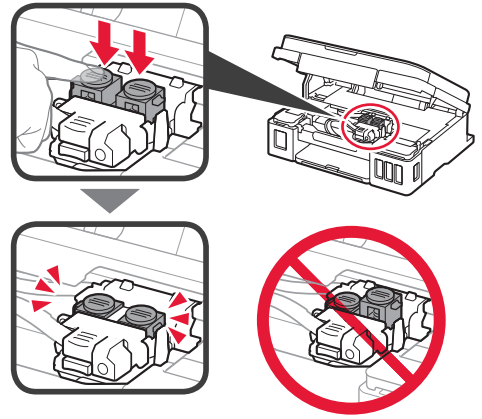

4. Turning on Printer



- 1 LIFT UP the scanning unit / cover, and then close it.

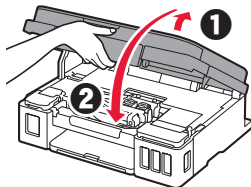

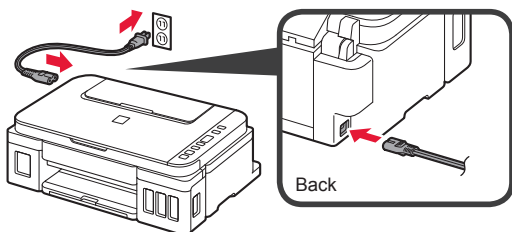

- 2 Connect the power cord.

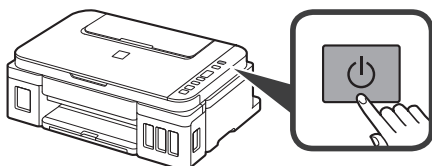

Do not connect any cables except the power cord yet.

- 3 Press the **ON** button.



- 4 Confirm that  (Ink icon) and  are displayed on the screen.

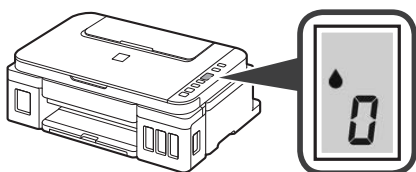

If a different screen appears, refer to "If any of the following screens appear" on page 3 to resolve the error.

5. Pouring Ink



This product requires careful handling of ink. Ink may splatter when the ink tanks are filled with ink. If ink gets on your clothes or belongings, it may not come off.

- 1 Open the scanning unit / cover.

- 2 Open the ink tank cover.

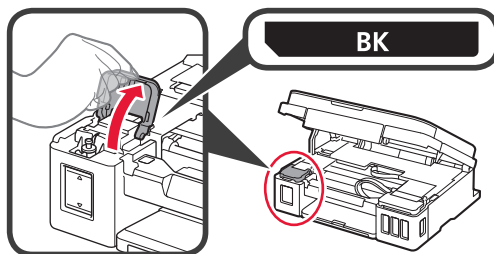

- 3 Grab and remove the tank cap of the ink tank.

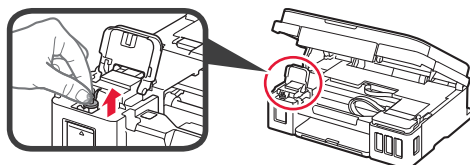

- 4 Hold the ink bottle upright and remove the bottle cap.

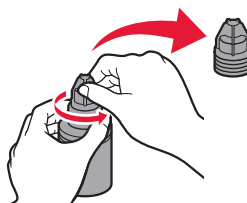

- 5 Insert the nozzle of the ink bottle into the inlet and stand the ink bottle upside down.

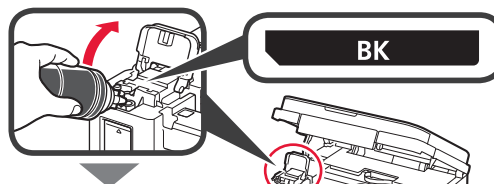

- 6 Pour all ink into the ink tank. Confirm that the ink has been filled to the upper limit line (A).

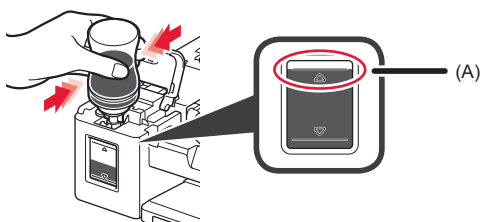

- 7 Replace the tank cap securely.

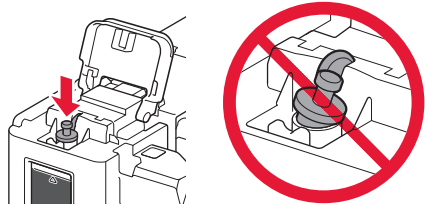

- 8 Close the ink tank cover.

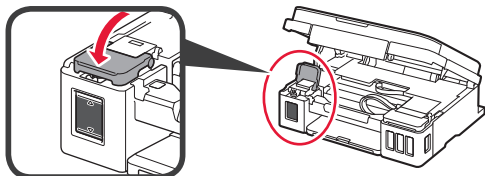

- 9 Repeat steps 2 to 8 to pour all ink into the corresponding ink tanks on the right according to the label.

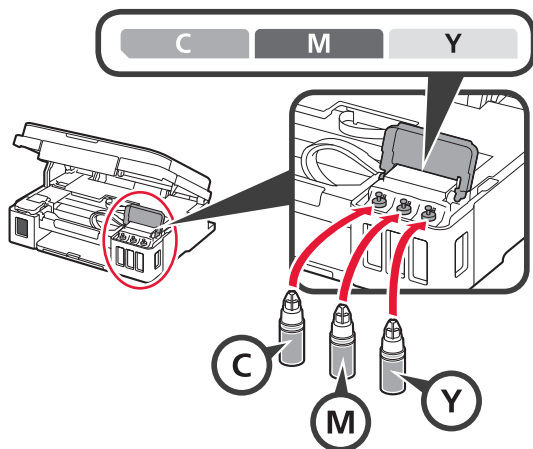

Confirm that the ink has been filled to the upper limit line (A).

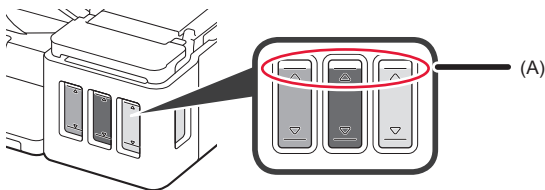

- 10 LIFT UP the scanning unit / cover, and then close it.

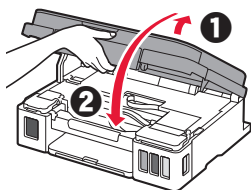

6. Preparing the Ink System

- 1 Press the **Black** button and confirm that  (Ink icon) disappears.

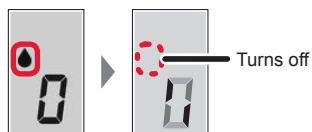
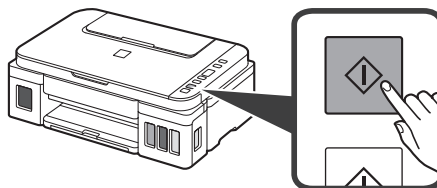

Ink preparation takes about 5 to 6 minutes.
Proceed to the next page.

? If any of the following screens appear

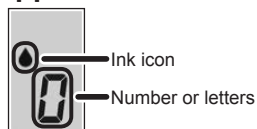

E04

The cartridges are not installed correctly.
→ "3. Installing the Cartridge" on page 1

E05

No cartridges are installed.
→ "3. Installing the Cartridge" on page 1

E09

The protective materials are not removed.
→ "2. Removing Packing Materials" on page 1

P08

Ink is not prepared normally.
Press the **ON** button to restart the printer, and then see "5. Pouring Ink" on page 2.

 **0**

Waiting to prepare ink.
→ "6. Preparing the Ink System"
If you have not poured ink into the ink tank yet, see "5. Pouring Ink" on page 2.

For all other cases, refer to the **Online Manual**.

7. Connecting to Computer

Windows



You need a connection setup for each computer. Proceed with the setup from step 1 for each computer.

If you use the printer while it is not connected to a computer, confirm that **i** is displayed on the printer's screen. The setup is now complete.

1 Start the setup file for either method **A** or method **B**.

A Downloading from the Internet

- 1 Open a web browser (e.g. etc.) on your computer.
- 2 Input the following URL and access the Canon website.

<http://ij.start.canon>



- 3 Select **Set Up**.



- 4 Input the model name of your printer and click **OK**.



You can select a model name from the list.

- 5 Click **Setup**.



The procedures for Windows are shown below. If you are using a computer with an OS other than Windows, do the setup according to the on-screen instructions.

- 6 Click **Download** and download the setup file.

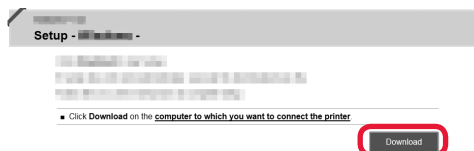

- 7 Execute the downloaded file.

Proceed to step 2 on the next page to continue.

B Using Setup CD-ROM (Windows Only)

■ When using Windows 10 or Windows 8.1:

- 1 Load the Setup CD-ROM in your computer.



- 2 When the following message appears on the right side of your computer screen, click it.



When This Message Does Not Appear (or Has Disappeared)

1. Click **File Explorer** on the taskbar.



2. Click **This PC** on the left side of the opened window.
3. Double-click the CD-ROM icon on the right side of the window.
If the contents of the CD-ROM appear, double-click **Msetup4.exe**.
4. Proceed to step 4.

③ If the following screen appears, click **Run Msetup4.exe**.

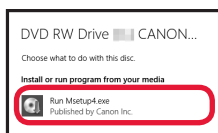

④ If the **User Account Control** dialog box appears, click **Yes**.

Proceed to step 2 to continue.

■ When using Windows 7:

① Load the Setup CD-ROM in your computer.



② When the **AutoPlay** screen appears, click **Run Msetup4.exe**.

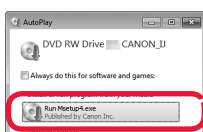

When **AutoPlay** Screen Does Not Appear

1. Click **Computer** from the start menu.
2. Double-click the  CD-ROM icon on the right side of the opened window. If the contents of the CD-ROM appear, double-click **Msetup4.exe**.

③ If the **User Account Control** dialog box appears, click **Continue**.

Proceed to step 2 to continue.

2 Click **Start Setup**.

If the following screen appears, click **Exit**.

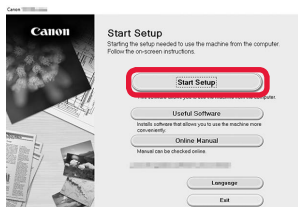

Follow the on-screen instructions to proceed with the setup.

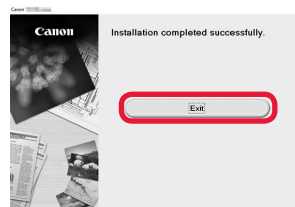

The setup is complete when  appears on the printer's screen. You can print from your computer.

Loading Paper



- 1 Open the paper support.

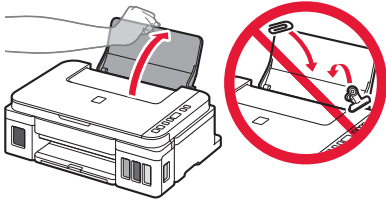

- 2 Slide the right paper guide to the end.

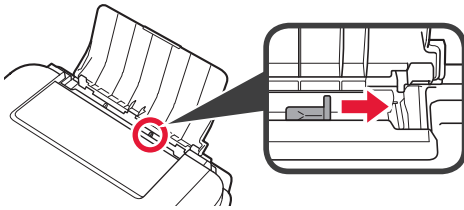

- 3
 - 1 Load paper with the print side facing up.
 - 2 Slide the right paper guide to align it with the side of the paper stack.

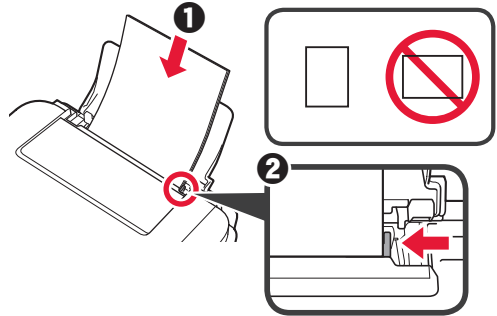

- 4
 - 1 Pull out the paper output tray.
 - 2 Open the output tray extension.

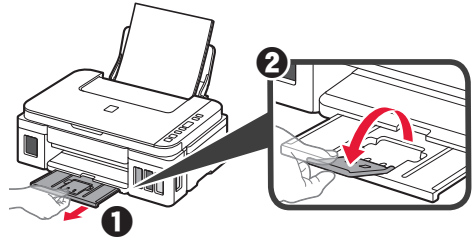

Copying

- 1 Make sure the printer is turned on.
- 2 Load plain LTR or A4 size paper.
- 3 Open the document cover and load the document face down on the platen glass. Align the document with the alignment mark (▼).

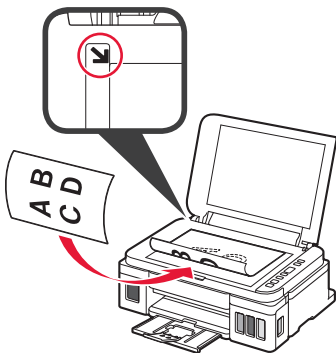

- 4 Close the document cover.

- 5 To make more than one copy, use the + button to set the desired number of copies.

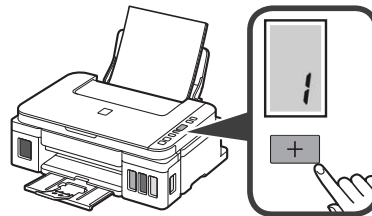

- 6 Press the **Black** button (A) for black & white copying. Press the **Color** button (B) for color copying. The printer starts copying.

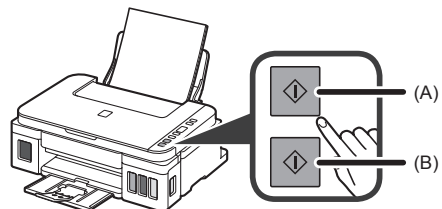

1. Comprobación de los elementos suministrados

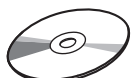
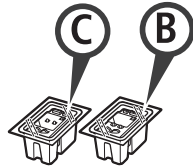
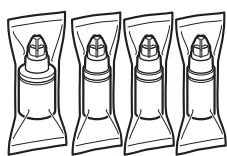
-  □ Cable de alimentación
-  □ CD-ROM de instalación para Windows PC
-  □ Cartucho
-  □ Frasco de tinta
- Información de seguridad e información importante
- Guía de inicio (este manual)

2. Retirar los materiales de protección



- 1 Retire los materiales de empaquetado (como la cinta naranja) del exterior de la impresora.
- 2
 - ❶ Abra la cubierta/unidad de escaneado.
 - ❷ Retire la cinta naranja y el material de protección y deséchelos.

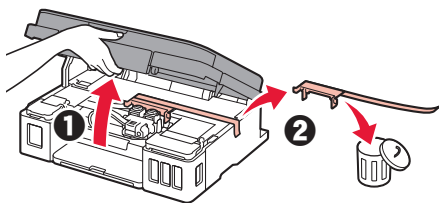

3. Instalar el cartucho



- 1 Abra la tapa de bloqueo del cartucho.

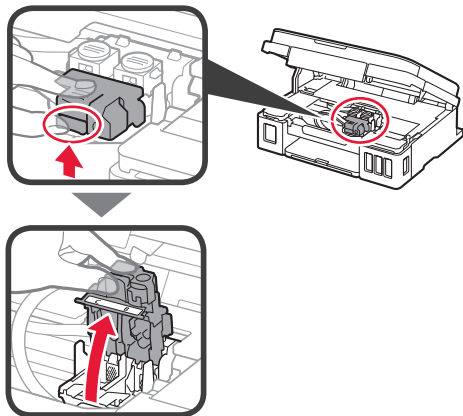

- 2 Saque el cartucho C (color) del paquete y retire la etiqueta.

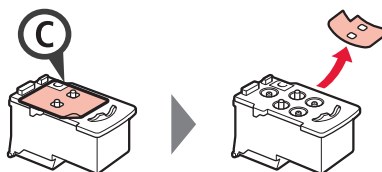

- 3 Retire la cinta protectora.

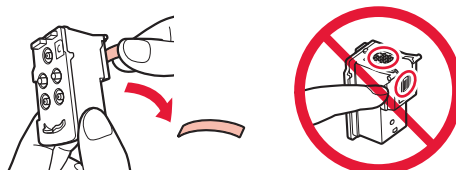

No tocar.

- 4 Inserte el cartucho C (color) en la parte izquierda.

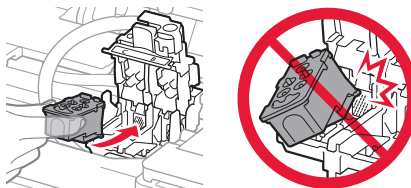

No golpear contra los objetos de alrededor.

- 5 Repita los pasos del 2 al 4 para insertar el cartucho B (negro) en la parte derecha.
- 6 Cierre la tapa de bloqueo del cartucho y presione hacia abajo.

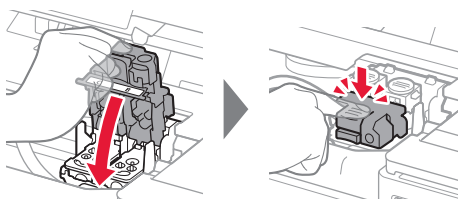

- 7 Presione hacia abajo ambos botones de unión.

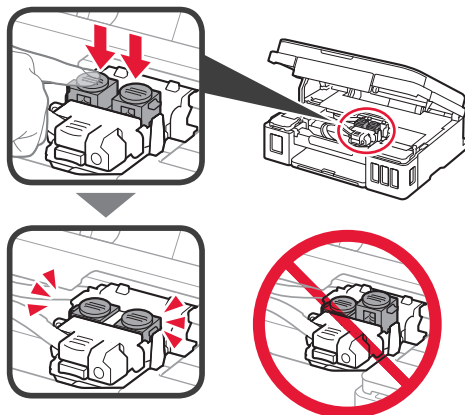

4. Encender la impresora



- 1 LEVANTE la cubierta/unidad de escaneado y luego ciérrela.

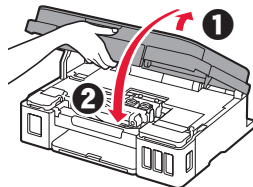

- 2 Conecte el cable de alimentación.

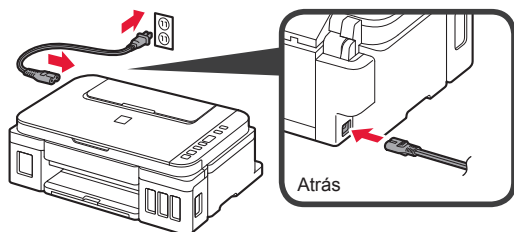

No conecte ningún cable excepto el de alimentación.

- 3 Pulse el botón **ACTIVADO (ON)**.

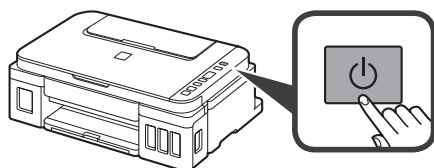

- 4 Confirme que  (icono Tinta (Ink)) y  se muestran en la pantalla.

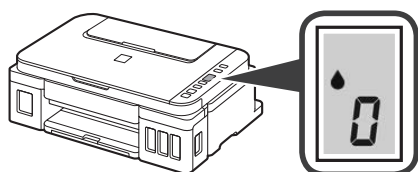

Si aparece una pantalla diferente, consulte "Si parece alguna de las siguientes pantallas" en la página 3 para resolver el error.

5. Verter la tinta



Este producto un tratamiento cuidadoso de la tinta, ya que puede salpicar cuando se rellenan de tinta los depósitos de tinta. Es posible que las manchas de tinta no salgan de la ropa u otras pertenencias.

- 1 Abra la cubierta/unidad de escaneado.

- 2 Abra la cubierta del depósito de tinta.

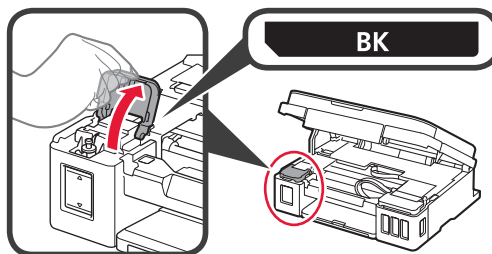

- 3 Agarre y retire la tapa del depósito del depósito de tinta.

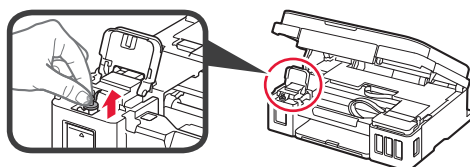

- 4 Sujete el frasco de tinta hacia arriba y retire la tapa del frasco.



- 5 Inserte el inyector del frasco de tinta en la entrada y coloque el frasco de tinta boca abajo.

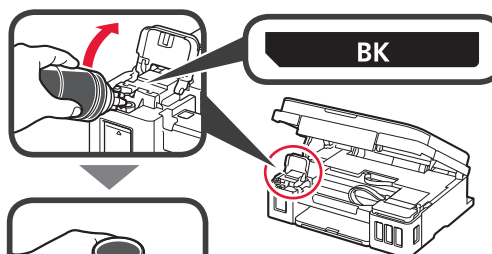

- 6 Vierta toda la tinta en el depósito de tinta. Confirme que se ha llenado la tinta hasta la línea de límite superior (A).

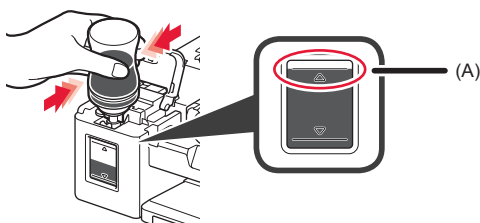

7 Vuelva a colocar firmemente la tapa del depósito.

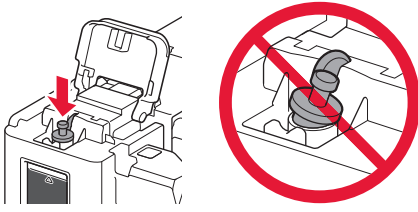

8 Cierre la cubierta del depósito de tinta.

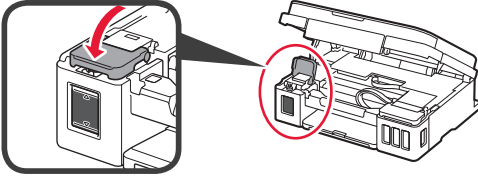

9 Repita los pasos del 2 al 8 para verter toda la tinta en los depósitos de tinta correspondientes de la derecha según la etiqueta.

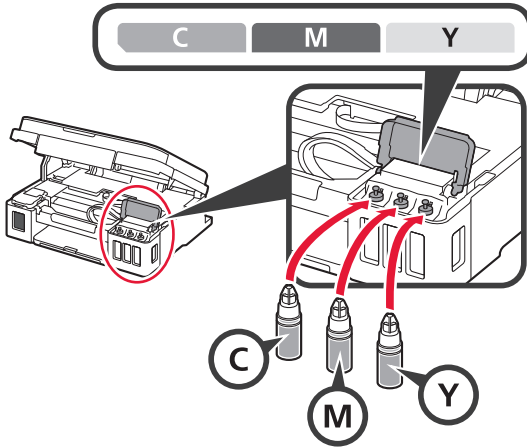

Confirme que se ha llenado la tinta hasta la línea de límite superior (A).

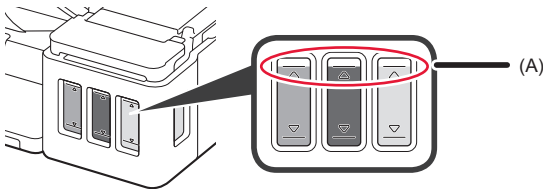

10 LEVANTE la cubierta/unidad de escaneado y luego ciérrela.

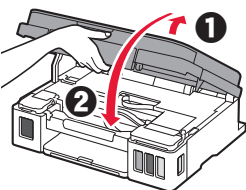

6. Preparando el sistema de tinta

1 Pulse el botón **Negro (Black)** y confirme que el icono Tinta (Ink) desaparece.

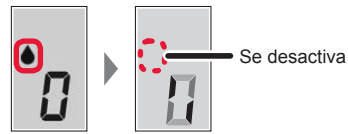
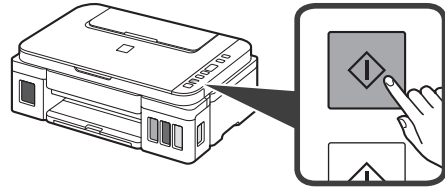

La preparación de la tinta tardará de 5 a 6 minutos en completarse. Continúe a la página siguiente.

? Si aparece alguna de las siguientes pantallas

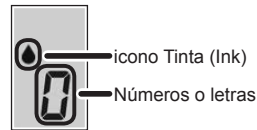

E04

Los cartuchos no están instalados correctamente.
➔ "3. Instalar el cartucho" en la página 1

E05

No hay cartuchos instalados.
➔ "3. Instalar el cartucho" en la página 1

E09

No se han retirado los materiales de protección.
➔ "2. Retirar los materiales de protección" en la página 1

P08

La tinta no está preparada normalmente.
Pulse el botón **ACTIVADO (ON)** para reiniciar la impresora y, a continuación, consulte "5. Verter tinta" en la página 2.

● 0

Esperando a preparar la tinta.
➔ "6. Preparando el sistema de tinta"
Si aún no ha vertido tinta en el depósito de tinta, consulte "5. Verter tinta" en la página 2.

Para los demás casos, consulte el **Manual en línea**.

7. Conexión con el ordenador

Windows



Necesita una configuración de conexión para cada ordenador. Siga con la configuración a partir del paso 1 para cada ordenador.

Si usa la impresora cuando no está conectada a un ordenador, confirme que  se muestra en la pantalla de la impresora. La configuración ya está finalizada.

1 Inicie el archivo de configuración del método **A** o el método **B**.

A Descarga de Internet

- 1 Abra un navegador web (, etc.) en su ordenador.
- 2 Escriba la URL siguiente y acceda al sitio web de Canon.

<http://ij.start.canon>



- 3 Seleccione **Configurar**.



- 4 Escriba el nombre del modelo de su impresora y haga clic en **Aceptar**.



Puede seleccionar un nombre de modelo de la lista.

- 5 Haga clic en **Configuración**.



Los procedimientos para Windows se muestran a continuación. Si el sistema operativo de su ordenador no es Windows, realice la configuración siguiendo las instrucciones en pantalla.

- 6 Haga clic en **Descargar** y descargue el archivo de instalación.

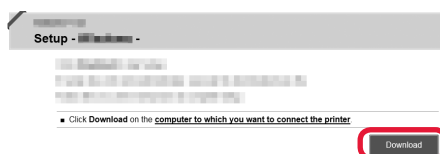

- 7 Ejecute el archivo descargado.

Vaya al paso 2 en la página siguiente para continuar.

B Uso del CD-ROM de instalación (solo para Windows)

■ Si utiliza Windows 10 o Windows 8.1:

- 1 Cargue el CD-ROM de instalación en su ordenador.



- 2 Cuando se muestre el mensaje siguiente en el lado derecho de la pantalla del ordenador, haga clic en él.



Si este mensaje no se muestra (o ya no aparece)

1. Haga clic en el **Explorador de archivos (File Explorer)** de la barra de tareas.



2. Haga clic en **Este equipo (This PC)** en la parte izquierda de la ventana que se abra.
3. Haga doble clic en el icono de CD-ROM  en el lado derecho de la ventana.
Si se muestra el contenido del CD-ROM, haga doble clic en **Msetup4.exe**.
4. Continúe en el paso **4**.

3 Si aparece la siguiente pantalla, haga clic en **Ejecutar Msetup4.exe (Run Msetup4.exe)**.

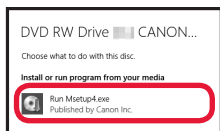

4 Si se muestra el cuadro de diálogo **Control de cuentas de usuario (User Account Control)**, haga clic en **Sí (Yes)**.
Vaya al paso 2 para continuar.

■ Si utiliza Windows 7:

1 Cargue el CD-ROM de instalación en su ordenador.



2 Cuando se muestre la pantalla **Reproducción automática (AutoPlay)**, haga clic en **Ejecutar Msetup4.exe (Run Msetup4.exe)**.

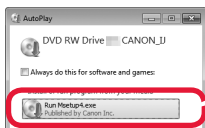

Si no se muestra la pantalla **Reproducción automática (AutoPlay)**

1. Haga clic en **Equipo (Computer)** en el menú de inicio.
2. Haga doble clic en el icono de CD-ROM en el lado derecho de la ventana abierta. Si se muestra el contenido del CD-ROM, haga doble clic en **Msetup4.exe**.

3 Si se muestra el cuadro de diálogo **Control de cuentas de usuario (User Account Control)**, haga clic en **Continuar (Continue)**.

Vaya al paso 2 para continuar.

2 Haga clic en **Iniciar configuración (Start Setup)**.

Si aparece la siguiente pantalla, haga clic en **Salir (Exit)**.

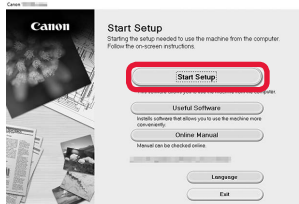

Siga las instrucciones en pantalla para continuar con la configuración.

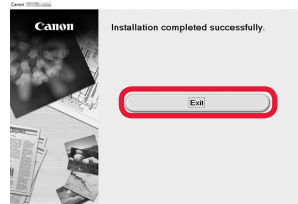

La instalación se habrá finalizado cuando **i** aparezca en la pantalla de la impresora. Ahora puede imprimir desde su ordenador.

Carga del papel



- 1 Abra el soporte del papel.

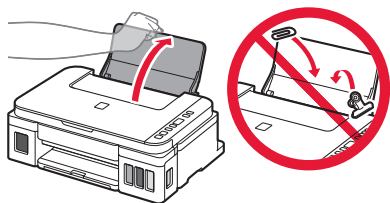

- 2 Deslice la guía del papel derecha hacia el final.

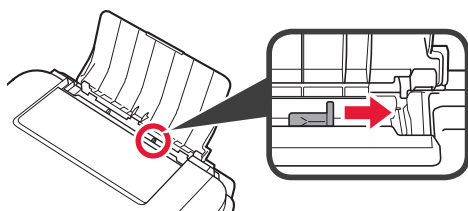

- 3
 - 1 Cargue papel con la cara imprimible hacia arriba.
 - 2 Deslice la guía del papel derecha para alinearla con el lado de la pila de papel.

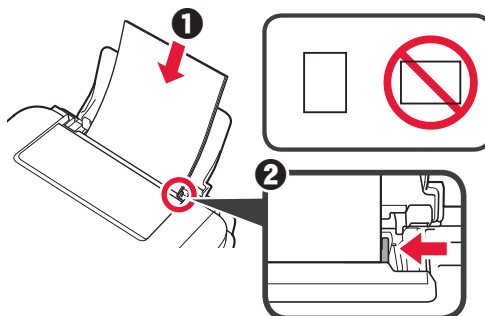

- 4
 - 1 Extraiga la bandeja de salida del papel.
 - 2 Abra la extensión de la bandeja de salida.

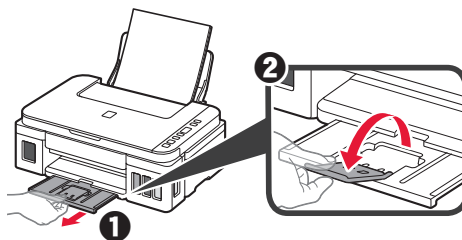

Copia

- 1 Asegúrese de que la impresora esté encendida.
- 2 Cargue papel normal tamaño A4 o LTR.
- 3 Abra la cubierta de documentos y cargue el documento cara abajo en el cristal de la platina. Alinee el documento con la marca de alineación (↘).

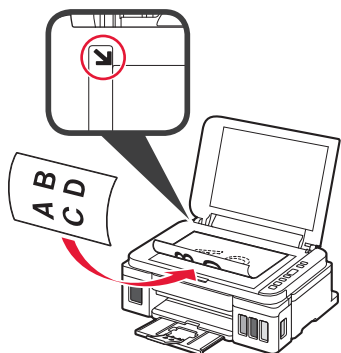

- 4 Cierre la cubierta de documentos.

- 5 Para hacer más de una copia, use el botón + para definir el número de copias deseado.

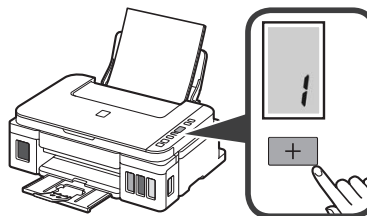

- 6 Pulse el botón **Negro (Black)** (A) para copias en blanco y negro. Pulse el botón **Color** (B) para copias en color. La impresora comenzará a copiar.

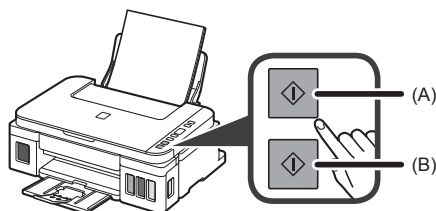

1. Verificando os itens incluídos

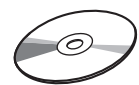
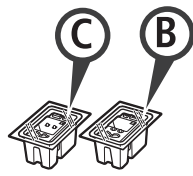
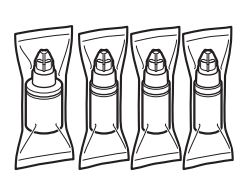
-  Cabo de alimentação
-  CD-ROM de instalação para Windows PC
-  Cartucho
-  Garrafa de tinta
- Informações Importantes e Sobre Segurança
- Para Começar (este manual)

2. Removendo os materiais da embalagem



- 1 Remova os materiais de embalagem (como a fita laranja) da parte externa da impressora.
- 2 **1** Abra a unidade de digitalização/tampa.
2 Remova a fita laranja e o material de proteção e descarte-os.

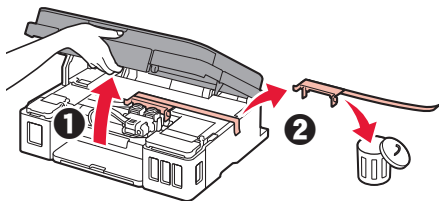

3. Instalando o cartucho



- 1 Abra a tampa de fixação do cartucho.

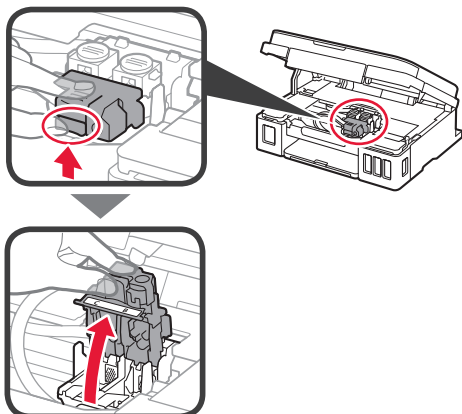

- 2 Tire o cartucho C (colorido) do pacote e remova a etiqueta.

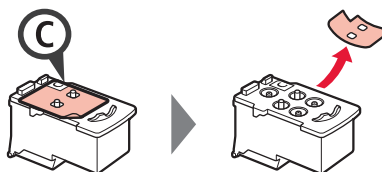

- 3 Remova a fita de proteção.

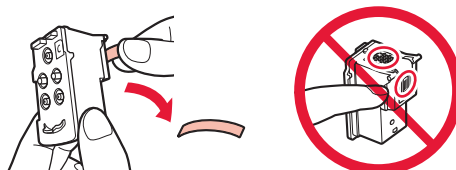

Não toque.

- 4 Insira o cartucho C (colorido) à esquerda.

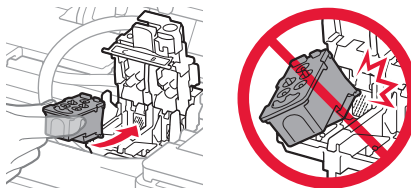

Não bata-a contra as peças em volta.

- 5 Repita as etapas de 2 a 4 para inserir o cartucho B (preto) à direita.

- 6 Feche a tampa de fixação do cartucho e empurre-a para baixo.

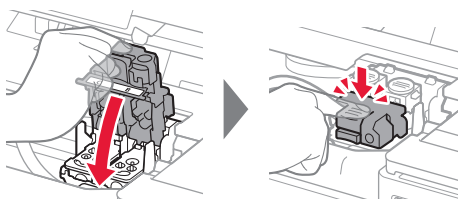

- 7 Pressione os dois botões acoplados para baixo.

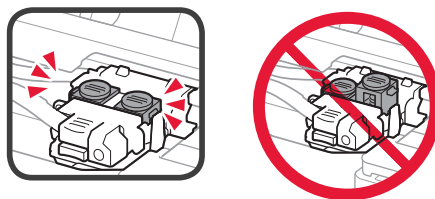
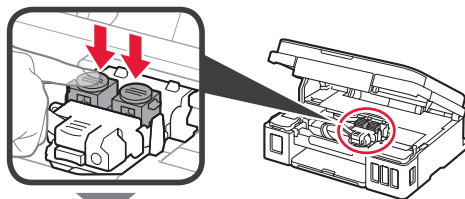

4. Ligando a impressora



- 1 LEVANTE a unidade de digitalização/tampa e abaixe-a em seguida.

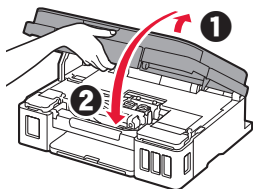

- 2 Conecte o cabo de alimentação.

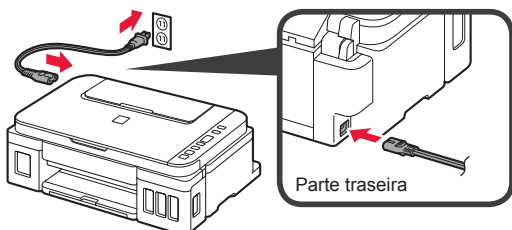

Não conecte os cabos ainda, exceto o cabo de alimentação.

- 3 Pressione o botão **ATIVADO (ON)**.

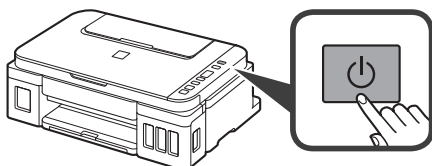

- 4 Confirme que o  (ícone Tinta (Ink)) e  sejam exibidos na tela.

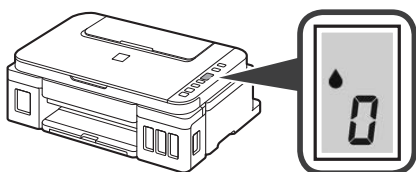

Se aparecer uma tela diferente, consulte "Se alguma das seguintes telas aparecer" na página 3 para resolver o erro.

5. Colocando tinta



Este produto requer manuseio cauteloso da tinta. A tinta pode respingar quando cartuchos de tinta estão cheios. Se a tinta entrar em contato com roupas ou objetos, pode ser que ela não saia.

- 1 Abra a unidade de digitalização/tampa.

- 2 Abra a tampa do cartucho de tinta.

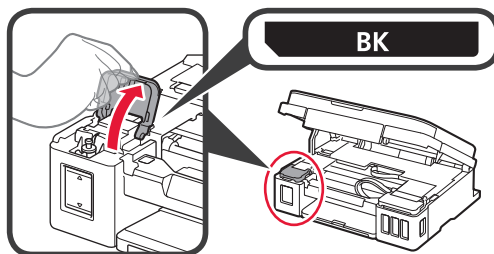

- 3 Segure e remova a tampa do cartucho do cartucho de tinta.

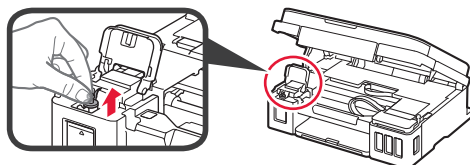

- 4 Segure a garrafa de tinta em posição vertical e remova a tampa da garrafa.



- 5 Insira o bocal da garrafa de tinta na entrada e segure a garrafa de tinta de cabeça para baixo.

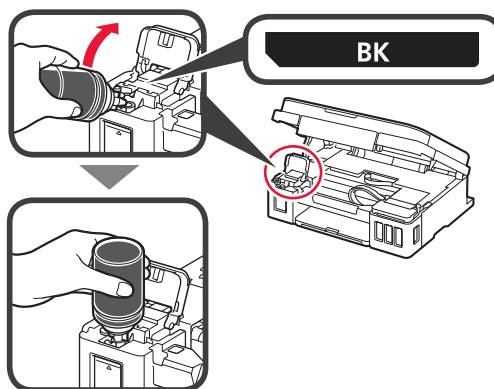

- 6 Coloque toda a tinta no cartucho de tinta. Confirme que a tinta tenha sido enchida até a linha de limite superior (A).

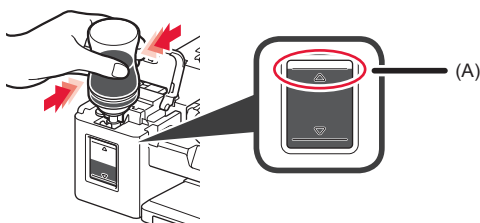

7 Recoloque firmemente a tampa do cartucho.



8 Feche a tampa do cartucho de tinta.

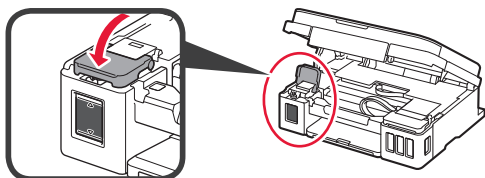

9 Repita as etapas de 2 a 8 para colocar toda a tinta nos cartuchos de tinta correspondentes à direita, de acordo com a etiqueta.

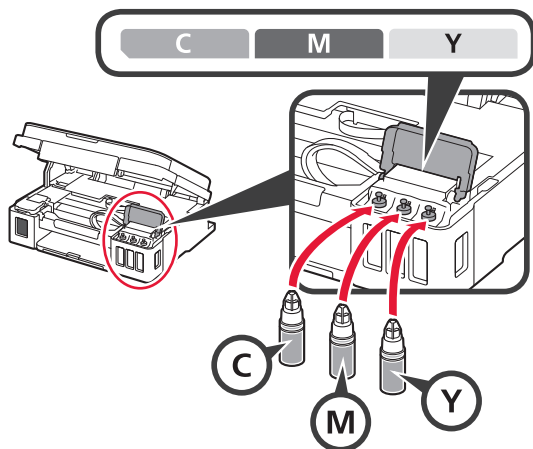

Confirme que a tinta tenha sido enchida até a linha de limite superior (A).

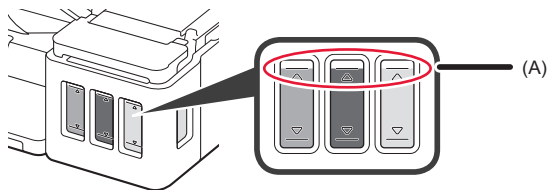

10 LEVANTE a unidade de digitalização/tampa e abaixe-a em seguida.

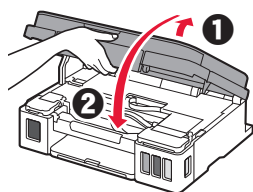

6. Preparando o sistema de tinta

1 Pressione o botão **Preto (Black)** e confirme que o  (ícone Tinta (Ink)) desapareça.

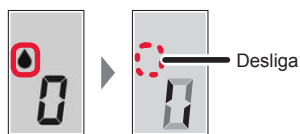
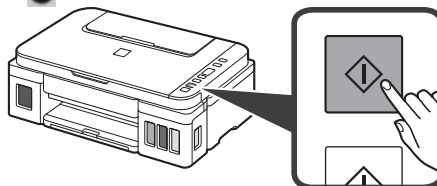

A preparação da tinta leva entre 5 a 6 minutos. Prossiga para a próxima página.

? Se alguma das seguintes telas aparecer

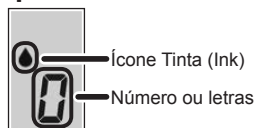

E04

Os cartuchos não estão instalados corretamente.

➔ "3. Instalando o cartucho" na página 1

E05

Nenhum cartucho instalado.

➔ "3. Instalando o cartucho" na página 1

E09

Os materiais de proteção não foram removidos.

➔ "2. Removendo os materiais da embalagem" na página 1

P08

A tinta não está preparada normalmente.

Pressione o botão **ATIVADO (ON)** para reiniciar a impressora e consulte "5. Colocando tinta" na página 2.

 **0**

Aguardando para preparar a tinta.

➔ "6. Preparando o sistema de tinta"

Se você ainda não tiver colocado tinta no cartucho de tinta, consulte "5. Colocando tinta" na página 2.

Para todos os outros casos, consulte o **Manual On-line**.

7. Conectando a um computador

Windows



Você precisa de uma configuração de conexão para cada computador. Prossiga com a configuração da etapa 1 para cada computador.

Se você usar a impressora enquanto ela não estiver conectada a um computador, confirme que  seja exibido na tela da impressora. A configuração foi concluída.

1 Inicie o arquivo de instalação para o método **A** ou o método **B**.

A Fazendo o download da Internet

- 1 Abra um navegador ( etc.) em seu computador.
- 2 Digite a URL a seguir e acesse o site da Canon.

<http://ij.start.canon>



- 3 Selecione **Configurar**.



- 4 Insira o nome do modelo da sua impressora e clique em **OK**.



Você pode selecionar um nome de modelo na lista.

- 5 Clique em **Configuração**.



Os procedimentos para Windows são mostrados abaixo. Se você estiver usando um computador com um sistema operacional que não seja o Windows, execute a configuração de acordo com as instruções na tela.

- 6 Clique em **Download** e faça download do arquivo de configuração.

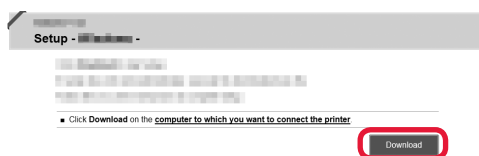

- 7 Execute o arquivo baixado.

Siga para a etapa 2 na próxima página para continuar.

B Usando o CD-ROM de instalação (somente Windows)

■ Ao usar Windows 10 ou Windows 8.1:

- 1 Insira o CD-ROM de instalação no computador.



- 2 Clique na mensagem a seguir quando ela for exibida no lado direito da tela do computador.



Quando esta mensagem não aparecer (ou tiver desaparecido)

1. Clique em **Explorador de Arquivos (File Explorer)** na barra de ferramentas.



2. Clique em **Este PC (This PC)** no lado esquerdo da janela aberta.
3. Clique duas vezes no ícone do CD-ROM  no lado direito da janela. Se o conteúdo do CD-ROM aparecer, clique duas vezes em **Msetup4.exe**.
4. Prossiga para a etapa **4**.

3 Se a tela a seguir for exibida, clique em **Executar Msetup4.exe (Run Msetup4.exe)**.

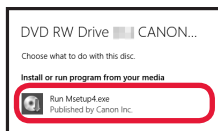

4 Se a caixa de diálogo **Controle de Conta de Usuário (User Account Control)** for exibida, clique em **Sim (Yes)**.
Siga para a etapa 2 para continuar.

■ Ao usar Windows 7:

1 Insira o CD-ROM de instalação no computador.



2 Quando a tela **Reprodução Automática (AutoPlay)** for exibida, clique em **Executar Msetup4.exe (Run Msetup4.exe)**.

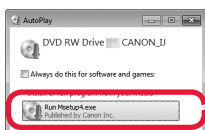

Quando a tela **Reprodução Automática (AutoPlay)** não for exibida

1. Clique em **Computador (Computer)** no menu Iniciar.
2. Clique duas vezes no ícone do CD-ROM  no lado direito da janela aberta.
Se o conteúdo do CD-ROM aparecer, clique duas vezes em **Msetup4.exe**.

3 Se a caixa de diálogo **Controle de Conta de Usuário (User Account Control)** for exibida, clique em **Continuar (Continue)**.

Siga para a etapa 2 para continuar.

2 Clique em **Iniciar configuração (Start Setup)**.

Se a seguinte tela for exibida, clique em **Sair (Exit)**.

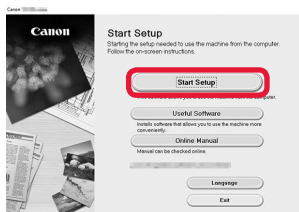

Siga as instruções na tela para prosseguir com a configuração.

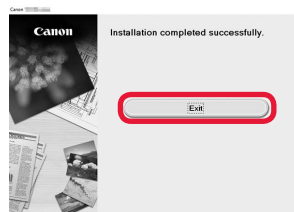

A configuração está completa quando **i** aparece na tela da impressora. Você pode imprimir do seu computador.

Colocando papel



- 1 Abra o suporte de papel.

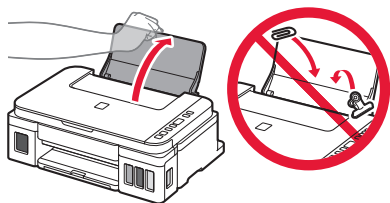

- 2 Deslize a guia do papel direita até o final.

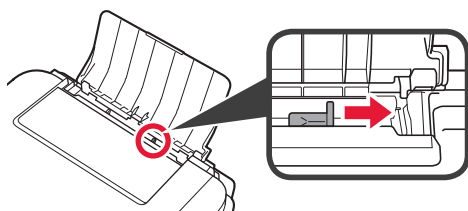

- 3
 - 1 Coloque papel com o lado a ser impresso voltado para cima.
 - 2 Deslize a guia do papel direita para alinhá-la à pilha de papel.

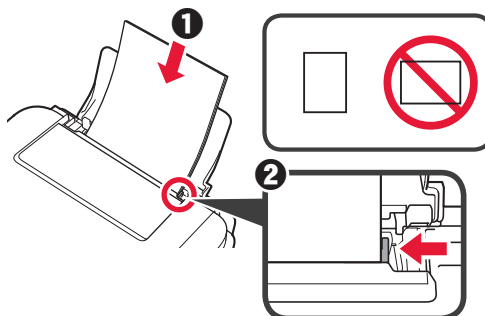

- 4
 - 1 Puxe para fora a bandeja de saída do papel.
 - 2 Abra a extensão da bandeja de saída.

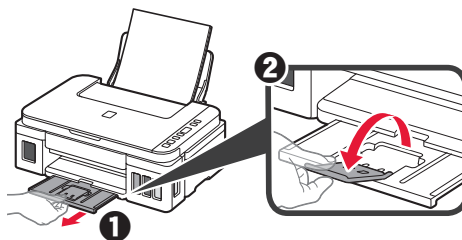

Copiando

- 1 Verifique se a impressora está ligada.
- 2 Coloque papel simples de tamanho LTR ou A4.
- 3 Abra a tampa de documentos e coloque o documento voltado para baixo no vidro de exposição. Posicione o documento com a marca de alinhamento (↙).

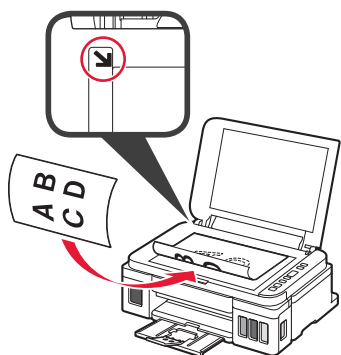

- 4 Feche a tampa de documentos.

- 5 Para fazer mais de uma cópia, use o botão + para definir o número de cópias desejado.

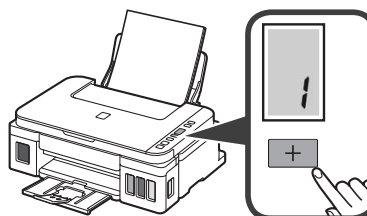

- 6 Pressione o botão **Preto (Black)** (A) para fazer cópias preto e branco. Pressione o botão **Colorido (Color)** (B) para fazer cópias coloridas. A impressora começa a copiar.

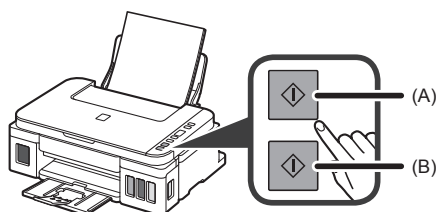



Access Online Manual

Acceso al Manual en línea

Acesse o Manual On-line



From browser

Desde el navegador

Do navegador

<http://ij.start.canon>

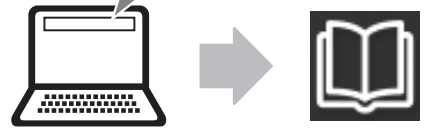

From desktop shortcut

Desde el acceso directo del escritorio

A partir do atalho da área de trabalho

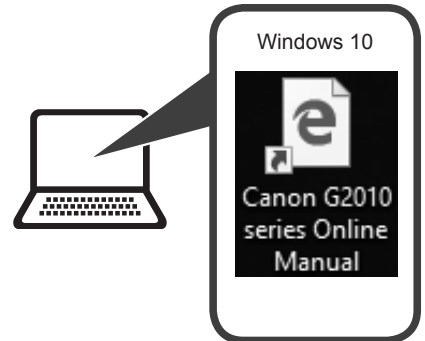

From browser

Desde el navegador

Do navegador

<http://ij.start.canon>

